



# SITE

YOUR  
BRUSH  
SOLUTION **2021**



**CATALOGO  
CATALOGUE**



**YOUR  
BRUSH  
SOLUTION**

**Bit**

**YOUR  
BRUSH  
SOLUTION**



Da cinque generazioni la mia famiglia è impegnata nello sviluppo della visione dei fondatori: assicurare ai propri clienti un servizio e un prodotto essenziale, solido, di qualità e sicuro, operando con costante senso di responsabilità, nel rispetto delle normative e dell'ambiente.

In oltre 110 anni di attività abbiamo acquisito un'importante esperienza e sviluppato rilevanti competenze e conoscenze. Oggi sono fiero del nostro team di collaboratori, della passione, della loro energia, del loro entusiasmo per SIT: elementi alla base della fiducia che i nostri clienti, rivenditori ed utilizzatori ci riconoscono. Clienti italiani ed internazionali apprezzano le nostre proposte di prodotti, le soluzioni costantemente all'avanguardia, il servizio su misura ad alto valore aggiunto, la semplicità di accesso e la relazione che da sempre connotano il nostro approccio al cliente.

Un'ampia gamma di prodotti fra cui trovare la risposta alle vostre esigenze; proposte di soluzioni customizzate; strumenti per esporre al meglio i nostri prodotti e moltiplicare le vendite, ma anche approfondimenti sulle modalità di scelta della migliore spazzola... questo è quello che potrete trovare in questo catalogo.

E se qualcosa non c'è, il nostro Customer Service, la Forza Vendita, l'Ufficio Tecnico e tutto lo Staff di SIT sono a vostra disposizione, con la competenza e la cordialità che distinguono la nostra "famiglia".

*For five generations, my family has been committed in fostering the founders' vision: to provide high quality, safe, reliable products and services operating in accordance with laws and standards and in respect of the environment.*

*In more than 110 years we have gathered a strong experience and we developed skills and know-how in our industry.*

*We comply with the social, economic and environmental context which we have always been part of.*

*Today I'm proud of our team, of their passion, energy and enthusiasm for SIT: the real background of the trust that our customers, resellers and end users recognize us.*

*Italian and international customers appreciate our products, our advanced solutions, the added value of our customized service, the ease of access and the relationship that has always characterized our approach to the customer.*

*We answer your needs offering a large inventory of standard products, custom-manufactured industrial brushes, several display solutions to increase sales and a clear guide about how to choose the most appropriate brush. In this catalogue you can find every information you may need.*

*Moreover, if something is missing, our Customer Service, the Sales Force, the Technical Department and all the SIT family is ready to help you, with our great experience and kindness.*

Sinceramente Vostro,

Andrea Acquaderni  
President & C.E.O





**IMPRENDITORIALITÀ,  
CONTINUITÀ,  
INNOVAZIONE**  
**ENTREPRENEURSHIP &  
CONTINUOUS INNOVATION**

**Q** > Qualità certificata e testata in ogni fase della produzione  
*Tested and certified quality in each production process*

p. 6

> Facciamo business in modo sostenibile  
*Sustainable business*

p. 8



**LA SPAZZOLA  
GIUSTA PER OGNI  
OPERAZIONE**  
**HOW TO CHOOSE  
THE RIGHT BRUSH**

**1** > Materiale da lavorare  
*Material to be processed*

p. 12

**3** > Dimensioni della spazzola  
*Brush size*

p. 17

**2** > Forma della spazzola  
*Brush shape*

p. 15

**4** > Diametro del filo  
*Filament diameter*

p. 17



**SMERIGLIATRICE  
ANGLE GRINDER**

**SPAZZOLE A TAZZA / CUP BRUSHES**

> Spazzole a tazza a mazzetti ritorti  
*Twist knot cup brushes*

p. 27

**SPAZZOLE CONICHE / BEVEL BRUSHES**

> Spazzole coniche a mazzetti ritorti  
*Twist knot bevel brushes*

p. 34

> Spazzole a tazza in filo ondulato  
*Crimped wire cup brushes*

p. 30

> Spazzole coniche in filo ondulato  
*Crimped wire bevel brushes*

p. 35



**TRAPANO  
DRILL**

**SPAZZOLE CIRCOLARI / WHEEL BRUSHES**

> Spazzole circolari  
*Stem mount wheel brushes*

p. 46

**SPAZZOLE A TAZZA E CONICHE / CUP AND BEVEL BRUSHES**

> Spazzole coniche  
*Stem mount bevel brushes*

p. 55

> Ruote lamellari e ruote di finitura  
*Flap wheels and finishing wheels*

p. 53

> Spazzole a tazza  
*Stem mount cup brushes*

p. 56



**MOLA  
BENCH  
GRINDER**

**SPAZZOLE CIRCOLARI / WHEEL BRUSHES**

> Spazzole circolari  
*Wheel brushes*

p. 70

> Riduzioni  
*Adapters*

p. 77

> Spazzole circolari di ampio spessore  
*Wide face wheel brushes*

p. 73



**LEVIGATRICE  
WHEEL  
SANDER**

**SPAZZOLE A RULLO PER LEVIGATRICI / BRUSHES FOR WHEEL SANDERS**

> Rulli per levigatrice Makita  
*Wheel brushes for Makita wheel sander*

p. 86

> Rulli per spazzolatrice Flex  
*Brushes for Flex brushing machines*

p. 88

> Rulli per levigatrici Festool  
*Roller brushes for Festool wheel sander*

p. 87

> Rulli, dischi e tazze per levigatrici  
*Staple set rollers, disc and cup brushes for sanders*

p. 89



**SPAZZOLE  
A MANO  
HAND  
BRUSHES**

> Spid

p. 92

> Varie  
*Various*

p. 95

> Dorso legno  
*Wooden body*

p. 94

> Slim

p. 95

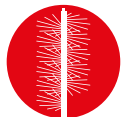

**SCOVOLI  
TWISTED-IN  
BRUSHES**

**SCOVOLI PER SBAVATURA / TWISTED-IN BRUSHES FOR DEBURRING**

> Scovoli per sbavatura  
*Twisted-in brushes for deburring*

p. 100

> Scovoli manuali  
*Manual twisted-in brushes*

p. 102



**STRIP**

> Strip porte  
*Strip brushes for doors*

p. 115

> Guaine  
*Tapes*

p. 117

> Strip portoni  
*Strip brushes for main doors*

p. 116

> Strip industrial  
*Industrial strip brushes*

p. 118



**VARIE  
VARIOUS**

> Spazzole coniche per decespugliatore  
*Bevel brushes for string trimmer*

p. 123

> Salvagronda  
*Gutter saver*

p. 125

> Scope e Laminoscope  
*Brooms and Sweepers*

p. 124

> Dischi  
*Discs*

p. 126



**SOLUZIONI  
ESPOSITIVE  
SOLUTIONS  
FOR DEALERS**

**GLI STRUMENTI DI SIT PER UNA EFFICACE ESPOSIZIONE / OUR SOLUTIONS FOR AN EFFECTIVE DISPLAY**

> Display MAXI

p. 136

> Espositori da banco  
*Desk display*

p. 137

> Display ROLLER

p. 136

> Display STRIP

p. 137



**SOLUZIONI  
TECNICHE  
TECHNICAL  
SOLUTIONS**

**MODALITÀ COSTRUTTIVE / MANUFACTURING TYPES**

> Strip - spazzole lineari  
*Strip linear brushes*

p. 146

> Spazzole ad anello  
*Single section wheel brushes*

p. 158

> Spirali e spazzole a rullo  
*Roller brushes and spirals*

p. 149

> Spazzole composite e sbavatura di metalli duri  
*Composite brushes and hard metal deburring*

p. 162

> Rulli Master  
*Master Rolls*

p. 156

> Spazzole punzonate  
*Staple set brushes*

p. 172



**SIT & SPORT**

> Salto con gli sci  
*Ski-jump*

p. 216

> Sci da discesa  
*Downhill ski*

p. 218

 > Semplici regole per un uso in sicurezza  
*Basic rules for safety in brushing*

p. 10

**5** > Stile del filo  
*Wire style*

p. 18

**7** > Sporgenza  
*Trim length*

p. 20

**6** > Densità del filo  
*Fill density*

p. 20

**8** > Potenza, Velocità e Pressione  
*Power, Speed, Pressure*

p. 20

#### SPAZZOLE CIRCOLARI / WHEEL BRUSHES

 > Spazzole circolari a mazzetti ritorti  
*Twist knot wheel brushes*

p. 38

 > Spazzole con attacco rapido  
*Brushes for XLOCK*

p. 41

 > Spazzole circolari in filo ondulato  
*Crimped wire wheel brushes*

p. 40

 > Box misti  
*Mixed Display boxes*

p. 42

#### PENNELLI / END BRUSHES

 > Pennelli  
*End brushes*

p. 59

 > Box misti  
*Mixed Display boxes*

p. 66

 > Mini spazzole  
*Mini brushes*

p. 65

#### ANELLI / SINGLE SECTION WHEELS

 > Anelli  
*Single sections wheels*

p. 79

 > Spazzole circolari  
*Wheel brushes*

p. 82

#### SCOVOLI PER CALDAIE, CAMINI E STUFE A PELLETTA / TUBE BRUSHES FOR BOILERS, CHIMNEYS AND PELLET STOVES

 > Scovoli per caldaie  
*Tube brushes for boilers*

p. 104

 > Scovoli per stufe a pellet  
*Tube brushes for pellet stoves*

p. 109

 > Scovoli per pulizia camino  
*Tube brushes for chimney cleaning*

p. 105

 > Varie  
*Various*

p. 111

 > Moduli punzonati  
*Stapled modular brushes*

p. 129

 > Spazzole Composite a disco  
*Composite disc brushes*

p. 130

> Spazzole in blister per smerigliatrice  
*Brushes in blister for grinder*

p. 139

> Spazzole in blister per trapano  
*Brushes in blister for drill*

p. 140

> Spazzole varie in blister  
*Various brushes in blister*

p. 141

#### APPLICAZIONI INDUSTRIALI / INDUSTRIAL APPLICATIONS

 > Trattamento leghe leggere e applicazioni del nylon abrasivo  
*Aluminium alloys treatment and abrasive nylon applications*

p. 174

 > Spazzole ricostruzione pneumatici  
*Brushes tyre retreading industry*

p. 190

 > Spazzole per trattamento legno  
*Brushes for woodworking*

p. 194

 > Spazzole per laminazione  
*Brushes for rolling mills*

p. 180

 > Unità Spazzolanti trattamento pannelli  
*Brushing Units for panels treatment*

p. 196

 > Unità spazzolanti per nastri trasportatori  
*Brushing units for conveyor belts*

p. 184

 > Spazzole per sbavatura tubi  
*Brushes for pipe deburring*

p. 199

 > Sci da fondo  
*Cross country ski*

p. 218

 > Golf, tennis, calcio, ...  
*Golf, tennis, soccer, ...*

p. 219

 > Spazzole per settore pipeline  
*Brushes for pipeline industry*

p. 202

> Spazzole per fonderia  
*Brushes for foundry industry*

p. 206

 > Spazzola pannelli fotovoltaici/solari  
*Brush for photovoltaic and solar panels*

p. 208

 > Schede di configurazione  
*Request forms / RFQ*

p. 210

 > Surf e altro...  
*Surf & more...*

p. 219

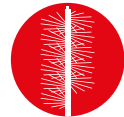

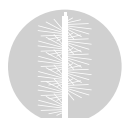

# IMPRENDITORIALITÀ, CONTINUITÀ, INNOVAZIONE ENTREPRENEURSHIP & CONTINUOUS INNOVATION

**SIT - Società Italiana TecnoSpazzole** è l'azienda italiana leader nella produzione di spazzole industriali e tecniche. Le nostre origini hanno le proprie radici nell'artigianalità della fabbricazione dei pennelli; il nostro presente è la tecnologia industriale applicata agli ambiti della finitura superficiale; il nostro futuro è nella costante innovazione nella finitura superficiale, sempre all'insegna della qualità e del contenuto di design che caratterizzano il prodotto Made in Italy, e di un'imprenditorialità orientata a uno sviluppo sostenibile.

**SIT - Società Italiana TecnoSpazzole** is the Italian leader in technical and industrial brushes manufacturing. SIT's origins date back to paint-brushes handicraft production; industrial applications for surface finishing are our present; continuous technical innovation is our future. Always following quality and design of Made in Italy products; always seeking sustainable development.

1662	1908	'50s	1966	'70s	1995 2002	2012	2018
<p>Tutto ha origine con il Laboratorio Artigianale per la Fabbricazione di Pennelli</p> <p><i>The beginning: "Laboratorio Artigianale per la Fabbricazione di pennelli"</i></p>  <p><b>pennellificio bolognese</b></p>	<p>Alessandro Acquaderni acquisisce il laboratorio e lo trasforma in "Pennellificio Bolognese", la prima fabbrica italiana di pennelli per uso industriale.</p> <p>La famiglia Acquaderni entra nel mondo della lavorazione del filamento e delle setole ponendo le radici di ciò che diventerà SIT.</p> <p><i>Alessandro Acquaderni acquires the workshop and turns it into "Pennellificio Bolognese" the first factory to manufacture paint-brushes for industrial use. The Acquaderni family enters the world of filament and bristle processing, setting the stage for SIT birth</i></p>	<p>Nasce SIT Società Italiana TecnoSpazzole, nel il nuovo stabilimento di Casalecchio di Reno (Bologna), spostando il focus sulle finitura superficiale applicata a diversi settori industriali.</p> <p><i>SIT Società Italiana TecnoSpazzole was born with a new plant in Casalecchio di Reno (Bologna) focusing on surface finishing applications in many industries.</i></p>	<p>Nasce SPID il prodotto simbolo di SIT, (ad oggi ne sono stati venduti più di 60 milioni di pezzi!!) e anche il più copiato...</p> <p><i>Birth of SPID, our best-known and most copied product (more than 60 million pieces sold!!).</i></p> 	<p>Grazie ai processi produttivi sempre all'avanguardia, in pochi anni SIT diventa leader nel settore industriale e in quello della ferramenta e utensileria</p> <p><i>Thanks to its advanced manufacturing processes within a few years SIT becomes the Italian leader in its industry.</i></p>	<p>Vengono ampliati l'area produttiva e gli uffici. Lo stabilimento viene così triplicato, consentendo il potenziamento con nuove macchine, nuove linee automatiche e nuovo personale, passi indispensabili per mantenere e consolidare la posizione di avanguardia nel proprio settore</p> <p><i>Manufacturing and office facilities are extended. The plant is tripled allowing a strong growth with new machines, new lines and new people. All these steps were essential to maintain the leadership position.</i></p>	<p>SIT rafforza la sua missione di imprenditorialità sostenibile costruendo un impianto fotovoltaico, lanciando nell'impresa la 5ª generazione della famiglia ed ampliando ulteriormente le capacità produttive con ingegneria ed automazione</p> <p><i>SIT focuses on its mission of sustainable entrepreneurship building a photovoltaic system, enrolling the family fifth generation and further increasing the production capacity through engineering and automation.</i></p>	<p>SIT celebra 110 anni di business di famiglia! La ricerca della migliore soluzione superficiale continua...</p> <p><i>SIT celebrate 110 years of family business! The research of the best surface finishing continue...</i></p> 
							

## La forza di un territorio / The strength of our territory

Da sempre SIT ha la propria sede operativa e il centro di sviluppo tecnologico nel cuore di uno dei distretti industriali più importanti in Europa, con particolare riferimento al settore della meccanica. Un territorio votato all'automotive - con nomi mitici come Ferrari, Lamborghini, Maserati e Ducati - alla produzione di macchine automatiche, alla robotica, all'imballaggio, al processamento del legno e del cibo.

Anche grazie a questa collocazione e alla collaborazione con partner tecnologici all'avanguardia, di cui è spesso anche fornitore, SIT è in grado di offrire ai propri clienti prodotti sempre innovativi e di alta qualità, con i migliori standard nei livelli di servizio. Caratteristiche, queste, necessarie e distintive, che aiutano SIT nell'esportazione dei prodotti e del marchio in tutti i mercati mondiali.

*SIT was born and raised within one of the most important and innovative European industrial districts, especially considering the mechanical field. The area is dedicated to automotive (Ferrari, Lamborghini, Maserati and Ducati) machinery production, robotics, packaging, wood and food processing.*

*Thanks to its location and through the collaboration with front-end technology partners and customers, SIT can offer innovative, high quality products at the highest service level. These hallmarks help SIT exporting its products and its brand all over the world.*



## Non solo spazzole industriali... / Not only industrial brushes...

Grazie alle sue applicazioni innovative, SIT fornisce tecnologie e prodotti anche al mondo dello sport, come le piste sintetiche da sci "QUATTROSTAGIONI", che riproducono efficacemente le caratteristiche del manto nevoso, inventate e brevettate da Pietro Acquaderni nel 1962. SIT è inoltre certificata per la progettazione, produzione e vendita di piste sintetiche da sci per discesa, fondo e salto. Vedi pag. 208.

*Thanks to its innovative nature and its passion, SIT has patented technologies and products in sports industry. In 1962 Pietro Acquaderni created and patented artificial ski slopes "QUATTROSTAGIONI", that reproduce the attributes of snow. SIT is certified also for the design, manufacture and sale of artificial ski slopes for downhill, cross-country and ski-jump. See page 208.*

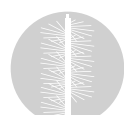

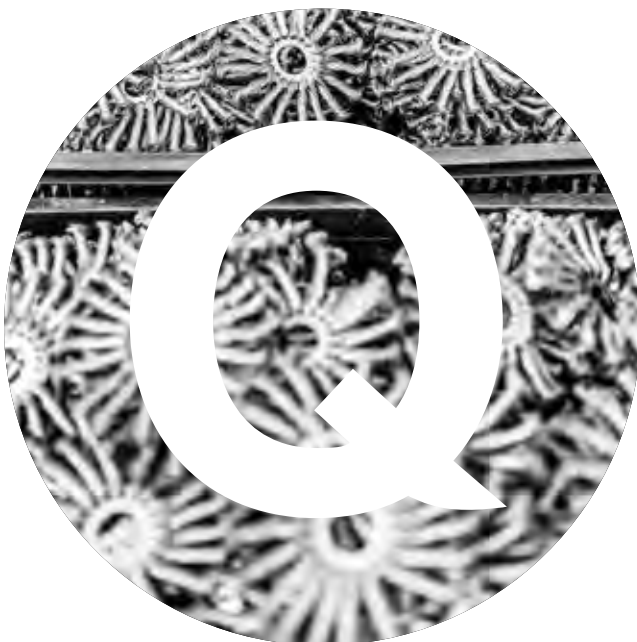

**QUALITÀ CERTIFICATA E TESTATA IN OGNI FASE DELLA PRODUZIONE**  
**TESTED AND CERTIFIED QUALITY IN EACH PRODUCTION PROCESS**



SIT è certificata da TÜV SÜD secondo lo standard di Qualità ISO 9001 per la progettazione, produzione, vendita e commercializzazione di spazzole per l'industria e per l'hobbistica.

La norma costituisce lo standard di riferimento per il conseguimento della qualità aziendale, definendo le procedure per il controllo dei processi che, attraverso l'azione commerciale, la progettazione e la produzione, conducono all'immissione dei prodotti sul mercato con soddisfazione del cliente, osservanza della sicurezza e rispetto dell'ambiente.

Attraverso il nostro approccio supportiamo i clienti, focalizzando l'attenzione sulla relazione tra gli obiettivi e i processi, verificando le aree di attenzione e identificando le opportunità di miglioramento. Allineare i propri processi produttivi allo standard ISO 9001 è la base del continuo miglioramento dell'organizzazione aziendale.

Consolidare la certificazione ISO 9001 per noi non significa guardare ai soli processi gestionali, ma anche porre una particolare attenzione alla costante formazione e aggiornamento di tutti i collaboratori e al loro coinvolgimento nella ricerca di soluzioni sempre più innovative.

*SIT is certified by TÜV SÜD following the quality standard of ISO 9001 for industrial brushes design, manufacture, sale and trade for industrial and DIY applications.*

*ISO certification is a benchmark for the quality management; it sets the regulations leading the manufacturing and management process, from which the quality of the product and the service offered depend.*

*Through this approach, we support our customers by focusing on the relationship between goals and processes, monitoring critical areas and identifying new improvement opportunities. The alignment of the production process to the standard ISO 9001 is the basis for a continuous improvement in quality and organization.*

*Moreover, being certified and keeping this certification means a lot to us since SIT pays particular attention to its collaborators; investing in their continuous training and upgrading and involving them in the research of innovative solutions.*



## Test di prestazione e di sicurezza / Performance and safety tests

Tutte le spazzole SIT vengono costantemente sottoposte a prove di resistenza, di durata e di rendimento; allo stesso modo vengono testati nuovi materiali e nuove tecnologie nella costruzione dei prodotti, con l'obiettivo costante di migliorarne l'efficacia e la sicurezza.

È un'attività quotidiana che ci consente di acquisire esperienza e controllo sulle variabili che determinano la prestazione delle spazzole, funzionali al continuo aggiornamento dei nostri prodotti.

Le spazzole SIT sono sottoposte a test di collaudo secondo la norma UNI EN 1083-2, che definisce i requisiti di sicurezza relativi alla costruzione delle spazzole. I test sono eseguiti all'interno di SIT mediante speciali macchine provatrici, appositamente costruite e tarate. I risultati dei test garantiscono la sicurezza di utilizzo del prodotto alla massima velocità dichiarata e, quindi, anche la sicurezza dell'utilizzatore che ne fa uso.

*SIT brushes are continuously tested for durability and performance; new materials and manufacturing technologies are tested in order to continuously improve products' effectiveness and safety.*

*This daily activity allows us to gain experience and control over the features influencing the brush performance, very important for our products' improvement.*

*SIT brushes are carefully tested in accordance to the UNI EN 1083-2 safety regulations concerning their manufacturing and use. The tests are carried out in SIT through a special testing machine, expressly built and set. The results of these tests ensure the safe use of the product to the maximum indicated speed and the safety of the operator as well.*



Il processo produttivo SIT è in linea con gli standard di qualità e sicurezza europei che prevedono impatto ambientale minimo, riciclaggio e raccolta differenziata dei rifiuti di produzione, continuo aggiornamento tecnologico, sperimentazione e ricerca ad alto livello.

*SIT manufacturing process complies with European standards of quality and safety, including low environmental impact, recycling and separate collection of production waste, continuous technological upgrading, testing and high-level research.*



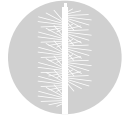

# FACCIAMO BUSINESS IN MODO SOSTENIBILE SUSTAINABLE BUSINESS

SIT da anni si dedica con l'impegno del proprio team e con investimenti specifici, nel perseguimento di un business sostenibile. "Imprenditorialità sostenibile" non significa solo investire in un'ottica di lungo termine, ma anche fare business nel rispetto dell'ecosistema sociale e ambientale nel quale l'azienda si trova e opera. Uno degli obiettivi primari per SIT è l'attenta valutazione dell'impatto ecologico del proprio lavoro e dei propri prodotti in tutti i passaggi della filiera, che va dal produttore all'utilizzatore finale.

*Since many years, SIT is committed to a sustainable business through specific investment and through its team efforts. "Sustainable entrepreneurship" is a business concept which focuses on both long term investment and respect for social and natural environment, where the company is set and operates. One of the primary goal for SIT is to carefully evaluate its products ecological impact throughout the supply chain, from the manufacturer to the end user.*

## Imballaggio e logistica / Packaging and logistics

SIT studia e sviluppa i propri imballaggi primari e secondari per essere costruiti con materiali riciclabili e biodegradabili. Le confezioni dedicate a contenere il prodotto sono ingegnerizzate per ottenere la miglior resa volumetrica nel trasporto, con conseguente minore impatto in termini di CO<sub>2</sub> generata. L'ottimizzazione degli imballaggi determina inoltre un minore utilizzo dei materiali di imballo (cartone) e quindi un minore consumo di materiali di origine vegetale.

*SIT designs its own primary and secondary packaging to be made from recyclable and bio-degradable materials. Primary packaging is engineered to obtain the best volumetric efficiency during transportation, greatly reducing the carbon footprint. Optimized dimensions also reduce the use of packaging material (cardboard) and the consumption of plant origin materials as well.*



## Riciclaggio dei materiali / Material recycling

Il team di SIT effettua una raccolta differenziata intensiva di tutti i materiali residui in tutte le aree aziendali. I contenitori di sostanze pericolose vengono gestiti in un ciclo di approvvigionamento e riutilizzo con il fornitore per essere riciclati o smaltiti alla fine della vita utile. Una parte degli imballaggi rotti e usati viene processata da macchinari e trasformata in materiale riempitivo delle scatole, in modo da preservare l'integrità delle spazzole.

Le spazzole sono prevalentemente (se non interamente) composte da elementi metallici riciclabili, che possono essere smaltiti a fine vita in modo differenziato secondo le normative locali. Nella progettazione dei nuovi prodotti, particolare attenzione viene data alla gestione del LCA (Life Cycle Assessment).

*Here in SIT everyone is committed in the separate collection of waste and non-used materials in all business areas.*

*Containers for hazardous materials are managed together with the supplier in a supply and reuse cycle, in order to be disposed or recycled at the end of their useful lifetime. Part of non-used or broken packages are processed in-house and turned into fill material which helps to protect brushes during transportation.*

*Industrial brushes are mainly (or entirely) made of recyclable materials that can be separately handled, at the end of the life cycle, in accordance with local legislation. In new products design, LCA (Life Cycle Assessment) management is very important.*



## Risparmio energetico / Energy saving

Nel 2012, per rafforzare il proprio impegno nei confronti dell'ambiente, SIT ha investito nella costruzione di un impianto fotovoltaico sul proprio stabilimento. Oltre 1400m<sup>2</sup> - 15070 ft<sup>2</sup> di superficie coperta con 870 pannelli fotovoltaici che producono 230 MWh all'anno, consentendo così un risparmio di 45 tonnellate di CO<sub>2</sub> equivalenti alla trasformazione ottenuta da 6 ettari - 15 acri di foresta.

*In 2012, SIT invested in the construction of a photovoltaic system, enhancing its environmental commitment. Over 1400 m<sup>2</sup> - 15070 ft<sup>2</sup> covered with 870 solar panels producing 230 MWh per year. The photovoltaic system saves up to 45 tons of CO<sub>2</sub> equal to the CO<sub>2</sub> amount processed by a 6 hectares - 15 acres forest.*



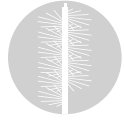

# SEMPLICI REGOLE PER UN USO IN SICUREZZA

## BASIC RULES FOR SAFETY IN BRUSHING



[www.sitbrush.com/safety](http://www.sitbrush.com/safety)

SIT cerca sempre di sviluppare il miglior prodotto possibile per le esigenze del cliente e per un utilizzo in sicurezza. Tutte le spazzole che vengono montate su utensili elettrici richiedono da parte dell'operatore l'osservazione di regole e modalità d'impiego specifiche.

*SIT always wants to provide to its customers the best product and service possible for an efficient and safe application. When using industrial brushes mounted on power tools, operators have to comply with specific rules and procedures to ensure maximum safety during operation.*



### PRIMA DELL'USO...

- conservare le spazzole nelle scatole originali, al riparo da calore, agenti chimici, polveri, fumi, liquidi ed umidità che possono causare deterioramento, contaminazione e rottura prematura
- controllare lo stato della spazzola e utilizzarla solo se è in buono stato. Una spazzola danneggiata o arrugginita può compromettere seriamente la lavorazione!
- verificare le condizioni dell'utensile elettrico/pneumatico e la presenza delle protezioni di sicurezza
- assicurarsi che nell'ambiente di lavoro vi sia un adeguato sistema di aspirazione e/o ventilazione
- **mai lavorare in atmosfere potenzialmente esplosive (ATEX)!**

### DURANTE L'USO...

- rispettare le restrizioni di velocità e non superare i valori indicati di Maximum Safe Free Speed (MSFS) o Max RPM **MAX RPM è il valore di massima velocità consentita e non la velocità di lavoro ideale!**
- evitare di esercitare una pressione eccessiva può causare piegatura e/o rottura del filamento e diminuire la durata della spazzola
- utilizzare una spazzola con filamento adeguato: si eviterà l'ossidazione della superficie lavorata
- ricordare che un errato utilizzo, può causare il danneggiamento e la rottura della spazzola
- le prestazioni e la sicurezza possono essere compromesse se la spazzola non viene utilizzata in posizione tangenziale alla direzione di rotazione

### BEFORE USE...

- *keep the brushes in their original boxes, not exposed to heat, acids, dust, fumes, liquids and high humidity that can cause deterioration, contamination and premature failure*
- *check the brush and use it only if it is in good conditions. Damages and rust may seriously compromise the job!*
- *maintain and check the machine/power tool and guard conditions*
- *provide proper suction systems and/or ventilation when working in a confined space*
- ***never work in ATEX classified areas (explosive atmosphere)!***

### DURING THE USE...

- *observe all speed restrictions and do not exceed Maximum Safe Free Speed (MSFS) or Max RPM value* ***MAX RPM is not the ideal working speed, but the maximum speed value allowed!***
- *avoid excessive brush pressure, it will cause wire bending and breakage, more heat and a decrease in brush life*
- *choose the appropriate fill material avoiding the oxidation of the processed surface*
- *remember that improper use may cause damage and breakage of the brush*
- *performance and safety can be compromised by not using the brush tangentially to the rotational axis.*

## Sicurezza dell'utente / User safety

Nelle operazioni di spazzolatura, il materiale rimosso (scorie, frammenti, residui) e i frammenti di filo possono essere proiettati ad alta velocità, causando potenziali lesioni all'utente. I Dispositivi di Protezione Individuale (DPI) devono essere indossati dall'utilizzatore della spazzola e da altre persone presenti nella zona di lavoro.

*In brushing operations the material being removed (burrs, scales, slags) and the wire brush tips lost will fly off the tool with high speed causing potential injury.*

*Personal Protective Equipment (PPE) must be worn by the brush operator and by others in the work area.*



ART: **WEP**  
REF. **1062**



## Montaggio / Mounting

Montando la spazzola controllare che il foro della spazzola si accoppi con il perno senza gioco eccessivo, in modo da garantire una rotazione regolare. Ricordare sempre di controllare il dado di serraggio e non utilizzare spazzole di dimensioni superiori a quanto consentito dall'attrezzatura.

*Check that brush arbor hole and spindle diameter are the same to ensure a perfect fit. Always check nut tightening and don't use brushes larger than the machine was designed for.*

Se si utilizza una spazzola con gambo cercare di accostarla il più possibile al mandrino.

*Shank mounted brushes: the overhang from the tool should be minimized.*

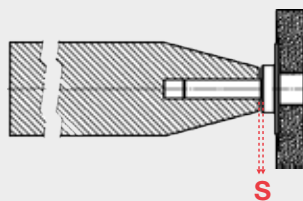

**S = 0**

(minimo possibile / minimum possible)

Per un utilizzo sicuro di spazzole a pennello il mandrino non deve essere serrato sul raggio alla base del pennello.

*End brushes: The collet/chuck shouldn't clamp on the radius at the base of the shank to ensure secure holding before use.*

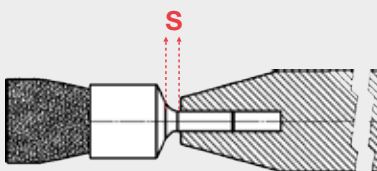

**S ≠ 0**

(non bloccare sul raggio / don't clamp on the radius)

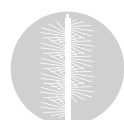

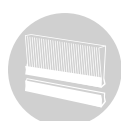

# LA SPAZZOLA GIUSTA PER OGNI OPERAZIONE

## HOW TO CHOOSE THE RIGHT BRUSH

Esistono infinite applicazioni e modalità di utilizzo di una spazzola. Forse non esiste la spazzola “perfetta” per ogni applicazione, ma una corretta selezione delle variabili costruttive guida alla scelta della spazzola ideale per la propria specifica esigenza di finitura superficiale.

La spazzola “giusta” permette di raggiungere l’obiettivo, di ottenere il lavoro desiderato (una determinata finitura superficiale) nel minore tempo e con la minore spesa (quantità di filamento o numero di spazzole, quindi denaro), o in altre parole con la maggiore efficienza.

Noi di SIT Tecnospazzole, con oltre 60 anni di esperienza, abbiamo individuato 8 fattori che determinano le prestazioni di una spazzola:

- 1 **Materiale da lavorare / Material to be processed**
- 2 **Scegliere la forma della spazzola / Choosing the brush shape**
- 3 **Scegliere la dimensione della spazzola / Choosing the brush size**
- 4 **Scegliere il diametro del filo / Choosing the filament diameter**
- 5 **Scegliere lo stile del filo / Choosing the wire style**
- 6 **Scegliere la densità del filo / Choosing the fill density**
- 7 **Scegliere la sporgenza del filo / Choosing the trim length**
- 8 **Potenza, velocità e pressione / Power, speed, pressure**

Queste variabili possono essere lette come 8 passaggi in sequenza che guidano l’utente alla scelta della spazzola più appropriata. Ogni utilizzatore deve analizzare questi passaggi considerando i vincoli e le peculiarità della propria applicazione (tipologia di superficie e tipologia di finitura) e del proprio modo di lavorare (ad esempio l’elettrotensile utilizzato o il gruppo motore o la macchina da banco disponibile).

SIT, come produttore specializzato, offre dall’altro lato una gamma completa di spazzole senza vincoli di materiale o dimensione. Ciò che non sarà trovato in questo catalogo potrà eventualmente essere fornito, previa specifica richiesta.

*There are endless applications and uses for industrial brushes. There may not be the “perfect” brush for each application but the proper selection of variables drives the choice in selecting the ideal brush for specific surface finishing requirements.*

*The “right” brush allows you to reach your surface finishing goal and to get the desired job done in less time and with lower cost of ownership (in terms of filament quantity or number of brushes, therefore saving money); in other words the right brush ensures greater overall efficiency.*

*Here at SIT Tecnospazzole, our 60 years of brush experience allowed us to identify eight variables that define the industrial brushes’ performance:*

*These variables drive the configurator of eight sequential steps that drive to the choice of the most appropriate brush.*

*Users must complete each step considering constraints and features of their specific application (working surface and type of finishing operation) and the way they work (available machinery and power tools).*

*SIT, as a customized brush manufacturer, offers a full range of industrial brushes without restrictions on materials or sizes. Products not listed in this catalogue can be provided, upon special request or specification.*

### 1 Materiale da lavorare / Material to be processed

Il materiale in lavorazione impone dei vincoli alla scelta della spazzola in termini di:

- **Compatibilità meccanica** - Proporzionalità tra la durezza dell’utensile e la durezza della superficie da trattare. Non è consigliabile effettuare una sbavatura leggera di un metallo tenero come l’alluminio con un filamento duro come l’acciaio al carbonio. Sarà invece consigliabile l’utilizzo di un filamento sintetico.
- **Compatibilità chimica** - Il filo deve resistere agli “attacchi” corrosivi dall’ambiente chimico di utilizzo. È sconsigliabile effettuare una spazzolatura di pulizia con acciaio al carbonio in presenza di soluzioni acide e in ambienti ad alta salinità e scongiurare il rischio di contaminazione del materiale da trattare (non è consigliabile spazzolare una superficie in acciaio inossidabile con spazzole d’acciaio al carbonio).

*Between the brush (filament) and the surface there must be:*

- **Mechanical compatibility** - Relation between the hardness of the tool and the surface to be treated. It’s not recommended to use hard carbon steel for light deburring of a soft metal like aluminium. An alternative recommendation is to use synthetic filaments.
- **Chemical compatibility** - The filament must withstand the corrosive attacks from the chemical environment. It’s not recommended to use carbon steel brushes in the presence of acid solutions and high salt environments and the contamination of the processed material must be avoided (it’s not recommended to use carbon steel brushes on stainless steel surfaces).



SIT offre un'ampia gamma di filamenti e di materiali che possiedono caratteristiche particolari e sono quindi adatti a specifiche finiture, per le quali SIT offre consulenza. Oltre ai filamenti mostrati in tabella sono disponibili filamenti o composizioni per particolari applicazioni tecniche o settori industriali, come ad esempio il nylon magnetizzato (rilevabile da metal detector) per l'industria alimentare.

SIT offers a wide range of filaments and materials. Please contact SIT for consultation on characteristics and compatibilities for specific operations. In addition to the ones shown in table, SIT can provide filaments for peculiar technical applications or industries, e.g. magnetic Nylon (metal detectable) for the food processing industry.

TIPOLOGIA / TYPE	FILAMENTO FILLING MATERIAL	INDICAZIONI PER L'USO	HINTS AND TIPS
 <b>Sintetici Synthetic</b>	<b>Polipropilene - PP (PPL)</b>	Buona resistenza ai fattori chimici, bassa densità, scarsa resistenza al freddo.	Good resistance to chemicals, low density, low resistance to cold temperatures.
	<b>Nylon - PA (NYL) 6/6.6</b>	Elevata resistenza e rigidità, stabile per dimensioni, scarsa dilatazione termica. Usato per applicare liquidi e pulire materiali abrasivi.	Great resistance and stiffness, stable size and low thermal expansion. Suitable to apply liquids and clean abrasive surfaces.
	<b>Nylon - PA (NYL) 6.10/6.12</b>	Tenace, resistente all'abrasione, assorbimento umidità inferiore al NYL6. Il meglio delle setole in termini di resistenza all'abrasione e assorbimento d'acqua. Usato per spazzolare con acqua e in casi difficili.	Tough, abrasion resistant and with lower moisture absorption than NYL6. The best in terms of resistance to abrasion and water absorption. Suitable in presence of water and in tough operating conditions.
	<b>Nylon - PA (NYL) 46</b>	Elevatissima resistenza alle alte temperature ed allo snervamento. Ottimo per pulire materiali abrasivi.	Very resistant to high temperatures and to yield stress. Excellent for abrasive materials cleaning.
	<b>Nylon - PA (NYL) 6 BILON</b>	Oltre alle caratteristiche standard del nylon 6, il Bilon ha una durata di 4 volte superiore al Nylon 6 in soluzioni alcaline a 70°C - 158°F (PH 7-13 e 70→75°C - 158→167°F).	In addition to standard Nylon 6 properties, Bilon is 4 times longer lasting in alkali solutions at 70°C - 158°F (PH 7-13 and 70→75°C - 158→167°F).
 <b>Sintetici abrasivi Abrasive synthetic</b>	<b>PolyVinilChloride (PVC)</b>	Buona resistenza ai fattori chimici, elevata rigidità. Usato per pulizia, deviazione, trasporto, protezione di parti mobili.	Good resistance to chemicals and great mechanical resistance. Used for cleaning, transportation and protection of moving parts.
	<b>PET - PBT Poliestere / Polyestere</b>	Buona combinazione di rigidità, durezza e durata. PBT: polibutilene tereftalato per uso alimentare.	Good combination of stiffness, hardness and durability. PBT: polybutylene terephthalate for food industry.
	<b>Nylon abrasivo / Abrasive Nylon</b>	Elevata resistenza e durezza, conserva la forma, ottima resistenza all'abrasione. Usato per sbavare metalli, materie plastiche, per levigare il legno e rendere ruvide le superfici. Le diverse grane disponibili determinano differenti rugosità superficiali, senza mai graffiare in profondità o compromettere la superficie lavorata.	Great resistance and stiffness, shape retention, great abrasion resistance. Suitable for metal and plastic deburring, wood sanding and surfaces roughening. Different grits available determine a different surface roughness, without scratching or consuming the part.
	<b>Carburo di Silicio / Silicon carbide</b>	La versione di nylon abrasivo più utilizzata. Disponibile anche nelle versioni HT speciali per resistenza ad alte temperature (fino a 250°C - 482°F).	The most common type of abrasive Nylon. Special filaments HT for high temperature resistance are available (till 250°C - 482°F).
	<b>Ossido o Silicato di Alluminio / Aluminium oxide</b>	Nylon abrasivo per finiture delicate, usato quando il Carburo di Silicio risulta troppo aggressivo. Più resistente all'impatto e meno soggetto a frattura rispetto al Carburo di Silicio.	Abrasive Nylon suitable for light finishing, when the Silicon Carbide is too aggressive. Greater resistance to impact and lower risk of breakage than Silicon Carbide.
	<b>Ceramico</b>	Nylon abrasivo per lavorazioni aggressive con velocità di taglio/lavoro e performance superiori al Carburo di Silicio.	Abrasive Nylon suitable for aggressive operations, with higher working speed and higher performance than Silicon Carbide.
	<b>Diamantato</b>	Nylon abrasivo per pulizia e finitura di precisione ad elevatissime performance. Disponibile anche nelle versioni HT speciali per resistenza ad alte temperature.	Abrasive Nylon suitable for cleaning and precision finishing with the greatest performance. Special filaments HT for high temperature resistance are available.
	 <b>Metallici ferrosi Ferrous metal</b>	<b>Acciaio / Steel</b>	Usato nella maggior parte delle applicazioni, generalmente a temperature elevate, sbavatura e pulitura di metalli, gomma e legno. Massima aggressività.
<b>Acciaio Inossidabile (Inox) AISI 302-304-316 / Stainless Steel AISI 302-304-316</b>		Resistente alla corrosione, alla ruggine e alle alte temperature. Ideale per applicazioni su acciaio inox, alluminio e metalli non ferrosi. Non lascia residui ossidanti sulla parte da trattare. I filamenti in inox 302 hanno struttura austenitica e, come risultato della laminazione, subiscono una leggera magnetizzazione.	Resistant to corrosion, rust and high temperatures. Ideal for S-Steel, aluminium and non-ferrous metals processing. It leaves non oxidizing residues on the treated surface. 302 Stainless steel filaments have austenitic structure and, as a result of lamination, undergo a slight magnetization.
 <b>Metallici non ferrosi Non-ferrous metal</b>	<b>Ottone / Brass</b>	Trattamento leggero di metalli, legno e pietre. Ideale per lavori su superfici in ottone, rame e per applicazioni che richiedono assenza di scintille.	Metal, wood and stone light treatment. Ideal for brass and copper surfaces and for anti-spark applications.
	<b>Bronzo fosforoso / Phosphorous Bronze</b>	Buona conduttività elettrica. Trattamenti superficiali leggeri di metallo e legno.	Good electrical conductivity. Light surface treatments of metal and wood.
 <b>Naturali Natural</b>	<b>Fibra vegetale Tampico / Vegetal fiber Tampico</b>	Non soggetto a elettricità statica. Utilizzato principalmente per la lavorazione superficiale del legno, per la levigatura dei metalli.	Non susceptible to static electricity. Mainly used for wood surface finishing, metal sanding.
	<b>Crine di cavallo / Horse hair</b>	Non soggetto a elettricità statica. Eccellente pulitura e spolvero. Utilizzata per chiusure ermetiche a secco e applicazione di liquidi, e per spazzolare superfici di legno lucidate e laminato.	Non susceptible to static electricity. Great for cleaning and dusting. Mainly used for sealing purposes (dry), liquids applications and on polished wooden surfaces or laminate.
	<b>Setola di maiale / Pig bristle</b>	Non soggetto a elettricità statica. Eccellente effetto di pulitura, chiusura ermetica e spolvero. Simile al crine ma più resistente e grossolano.	Non susceptible to static electricity. Great for cleaning, dusting and sealing purposes. Similar but more resistant than horse hair.

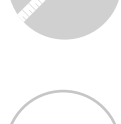
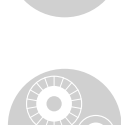
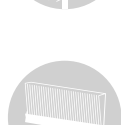



## QUALE FILAMENTO SCEGLIERE? / HOW TO CHOOSE THE FILAMENT?

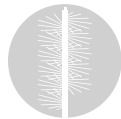

	ALLUMINIO ALUMINIUM	OTTONE BRASS	GHISA CAST IRON	COMPOSITO COMPOSITE	RAME COPPER	VETRO GLASS	METALLI DURI HARD METAL CARBIDES	PLASTICA PLASTIC	GOMMA RUBBER	ACCIAIO STEEL	ACCIAIO INOX STAINLESS STEEL	PIETRA, MATTONI STONE, BRICK	TITANIO TITANIUM	LEGNO WOOD
ACCIAIO STEEL	✗	✗	✓	👍	✗	✗	👍	✓ Irruvidire, Rusticare Roughening, Aging	✓ Raspare Buffing	✓ Rimuovere rivestimenti, Preparare/Pulire saldature, Sbavare Coating removal, Weld preparation / cleaning, Deburring	✗	👍	✗	✓ Rusticare, Rimuovere rivestimenti Aging, Coating removal
INOX STAINLESS STEEL	👍	👍	✗	✗	👍	✗	✗	✗	👍	👍	✓ Preparare/ Pulire saldature, Sbavare Weld preparation / cleaning, Deburring	✓	✓ Sbavare, Pulire saldature Deburring, Weld cleaning	👍
OTTONE BRASS	👍	✓ Sbavare Deburring	✗	✗	👍	✗	✗	✗	✗	✗	✗	✓ Pulire Cleaning	✗	👍
BRONZO FOSFOROSO PHOSPHO- ROUS BRONZE	👍	👍	✗	✗	👍	✗	✗	✗	✗	✗	👍	✗	✗	👍
NYLON ABRASIVO ABRASIVE NYLON	✓ Sbavare Graffiare (grana grossa) Deburring, Texturing (coarse grit)	✓ Satinare (grana 320-500) Satining (grit 320-500)	✗	✓	✓ Rifinire, Sbavare Finishing, Deburring	✗	✓	✗	✗	👍 Rifinire Finishing	👍 Rifinire Finishing	👍 Rusticare Aging	👍 Rifinire Finishing	👍 Rusticare Aging
PP (PPL) PA (NYLON) PVC PET/PBT	👍 Pulire Cleaning	👍 Pulire Cleaning	✗	✗	👍 Pulire Cleaning	👍	✗	👍	👍 Spolverare Dusting	✗	👍	✗	✗	👍 Pulire Cleaning
VEGETALE VEGETAL (TAMPICO)	✗	✗	✗	✗	✗	✗	✗	✗	✗	✗	✓ Satinare Satining	✗	✗	✓ Spolverare Dusting
ANIMALE (CRINE CAVALLO, SETOLA MAIALE) ANIMAL (HORSE HAIR, PIG BRISTLE)	✗	✗	✗	✗	✗	👍	✗	✗	✗	✓ Lucidare Polishing	✓ Lucidare Polishing	✗	✗	✓ Spolverare Dusting

- ✓ Migliore combinazione / Best fit
- 👍 Soluzione accettabile / Admissible solution
- ✗ Utilizzo non raccomandabile / Non recommended

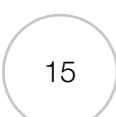
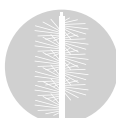

Materiale / Material	Peso specifico Specific weight g/cm <sup>3</sup>	Assorbimento acqua Water absorption %	Limiti di esercizio / Operating limits				Resistenza a / Resistance to					
			Caldo / Hot		Freddo Cold °C	Fuoco Fire °F	Abrasion Abrasion 0-20	Lubrificanti Lubricants (20°C - 68°F)	Benzina Petrol (20°C - 68°F)	Acidi Acids (20°C - 68°F)	Alcalini Alkali (20°C - 68°F)	
			Umido Wet K/W	Secco Dry K/W								
Polipropilene / Polypropylene - PP (o PPL)	0,91	0	80	90	0	32	AA	6	R	PS	R	R
Nylon - PA (NYL) 6/6.6	1,14	8	100	140	-40	-8	AA	9	R	R	PS5	R
Nylon - PA (NYL) 6.10/6.12	1,08	4	100	120	-40	-8	AA	10	R	R	PS5	R
Nylon - PA (NYL) 46	1,18	4	150	190	-20	12	AA	9	R	R	PS5	R
Nylon - PA (NYL) 6 BILON	1,14	8	100	140	-40	-8	AA	9	R	R	PS5	R+
Nylon abrasivo / Abrasive Nylon	1,25	4	100	120	-40	-8	AA	14	R	R	PS5	R
PolyVinilChloride (PVC)	1,40	0	50	60	-30	2	AE	4	R	PS	R	R
PET - PBT Poliestere / Polyestere	1,35	1	100	130	-40	-8	AA	9	R	PS	PS	R
Acciaio / Steel	7,85	0	300	300	-	-	NI	18-20	R	R	PS	PS
Acciaio inossidabile inox / Stainless steel AISI 302-304-316	7,90	0	400-450	400-450	-	-	NI	17	R	R	R	R
Ottone / Brass	8,50	0	160-180	160-180	-	-	NI	14	R	R	PS	PS
Bronzo fosforoso / Phosphorous Bronze	8,80	0	160-180	160-180	-	-	NI	14	R	R	PS	PS
Fibra vegetale Tampico / Vegetal fiber Tampico	-	35	150	160	-	-	AA	-	PS	PS	PS	PS
Crine di cavallo / Horse hair	-	35	140	150	-	-	AA	-	PS	PS	PS	PS
Setola di maiale / Pig bristle	-	40	140	150	-	-	AA	-	PS	PS	PS	PS

**AA** = autoalimentante / self-banking  
**AE** = autoestinguente / self-extinguishing  
**NI** = non infiammabile / non-inflammable  
**R** = resistente / resistant  
**PS** = parzialmente solubile / partially soluble  
**PS5** = non resistente in acidi con pH < 5 / non-resistant to acids with pH < 5  
**R+** = resistente fino a 70-75°C / resistant up to 70-75°C

## 2 Scegliere la Forma della spazzola / Choosing the brush shape

La forma e la dimensione della spazzola devono essere scelte considerando la geometria del pezzo da lavorare, il tipo di spazzolatura, l'utensile a disposizione e l'ambiente di lavoro. Per esempio, per effettuare spazzolature "piane" la scelta deve ricadere su spazzole a tazza, spazzole frontali o spazzole a rullo.

Brush size and shape must be chosen considering the part shape, the specific brushing operation, the power tool and the working environment. (For example, cup, disc or roller brushes are recommended for working on flat surfaces).

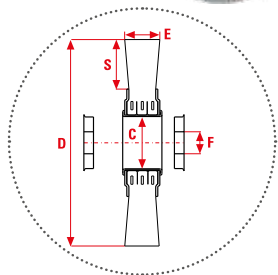

- Spazzole circolari per pulire cavità tra piani paralleli o per sbavare spigoli (pulizia di saldatura entro cianfrini, tra le testate di tubi o sbavatura testate di tubi). Circolari di ampio spessore e rulli per pulire larghe superfici piane. Wheel brushes suitable for cavities cleaning and edges deburring (weld cleaning within chamfers or pipe heads, pipes deburring). Wide face wheels and rollers for wide flat surfaces finishing.

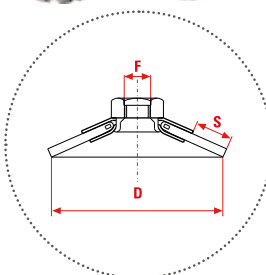

- Spazzole coniche per pulire superfici concave o rientranze, dove altre spazzole sarebbero limitate dalla geometria dell'elettro-utensile. Bevel brushes ideal for irregular surfaces with edges and corners, where other brush shapes would be hampered by the power tool shape and size.

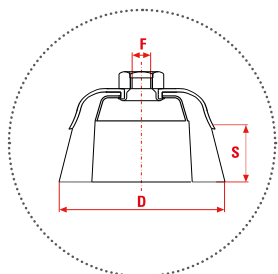

- Spazzole a tazza e a disco per pulire superfici piane, dal momento che permettono di spazzolare facilmente e "per larghe fasce" una superficie. Cup and disc brushes ideal for flat surfaces. They allow to brush wide bands and ease surface finishing operations.

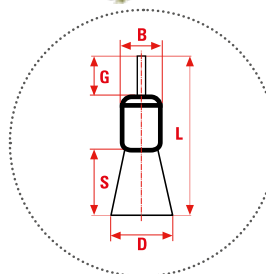

- Spazzole a pennello per pulire fori e spazi confinati. Il filo a riposo può essere introdotto nei fori e, quando posto in rotazione ad elevati RPM, si apre portandosi a contatto con le pareti. Viceversa, la divergenza del filo non permetterebbe la spazzolatura di superfici piane. End brushes suitable for holes and cavities cleaning. Filling material can be set inside holes than once it starts spinning it will spread out allowing the cavity side walls' brushing. For this same reason end brushes wouldn't be suitable for flat surfaces brushing.



## QUALE FORMA SCEGLIERE? / HOW TO CHOOSE THE BRUSH SHAPE?

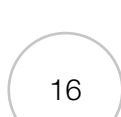

### ACCIAIO STEEL

### INOX S/STEEL

### NON FERROSI NON FERROUS

### LEGNO WOOD

### PIETRA STONE

Sbavare e  
raggiare spigoli  
(esterni)  
*Edge deburring  
and radiusing*



Sbavare e  
raggiare fori  
*Holes/ Bores  
deburring and  
radiusing*



Pulire  
saldature  
*Weld cleaning*



Scrostare,  
decapare,  
sverniciare  
e rimuovere  
ruggine  
*Descaling,  
Pickling,  
Coating and  
rust removal*



Rusticare,  
strutturare,  
satinare  
*Aging, Forming,  
Satinning,*

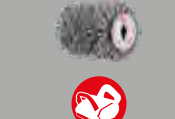
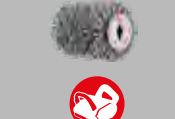
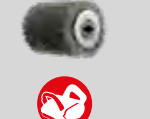

Pulire e  
lucidare  
*Cleaning and  
polishing*



Alla scelta della forma contribuisce infine l'elemento di montaggio sulla macchina portautensile. Molte spazzole possono essere assemblate con una riduzione filettata, con un foro semplice, o con un gambo, a seconda dell'utensile o macchinario su cui verranno montate.

*The brush shape is influenced by the mounting on the power tool or machine engine. Many brushes are manufactured with a threaded nut, plain bore or with a shank depending on the tool, spindle-holder or mandrel they will be mounted on.*



### 3 Scegliere la dimensione della spazzola / Choosing the brush size

Il diametro della spazzola influenza la velocità periferica. In generale, quanto maggiore è il diametro della spazzola, tanto minore è il numero complessivo di rotazioni necessario per compiere il lavoro di asportazione superficiale quindi tanto minore è il tempo impiegato per il suo completamento. Per l'efficienza della spazzolatura è dunque raccomandabile scegliere il diametro di spazzola maggiore compatibile con l'utensile utilizzato, con il carter di protezione e con la velocità massima di rotazione consentita dall'apparecchio.

*Brush Outer Diameter influences peripheral speed. Generally the higher the OD the lower the number of rotations to obtain the surface removal job. So less time to do the same work. In order to improve the efficiency it's recommended to choose the biggest Outer Diameter possible consistently with the used tool, the tool guards, and the tool maximum safe speed.*

**Abbinamenti indicativi tra velocità di rotazione massima e diametro massimo dell'utensile per le più comuni smerigliatrici angolari in commercio.**

***Matching between max rotating speed and max tool diameter for the most common angle grinders available on the market.***

Diametro max	115mm	125mm	150mm	180mm	230mm
Max diameter	4-1/2"	5"	6"	7"	9"
Velocità max Max free speed	12'500 rpm	11'000 rpm	9'000 rpm	8'500 rpm	6500 rpm

È necessario tenere bene presente, specie per le tipologie a sviluppo quasi mono-dimensionale come tazze o pennelli, che il diametro può aumentare considerevolmente quando le spazzole sono poste in rotazione.

Dato che le scelte di diametro e velocità angolare sono correlate, si veda anche la sezione relativa a Potenza, Pressione e Velocità.

SIT produce spazzole con diametro da 1mm - 0,04" a 1000mm - 40" e nel nostro catalogo l'utilizzatore troverà un range di dimensioni consigliate per ogni applicazione e tipologia di prodotto.

*Be aware that the Outer Diameter of end brushes and cup brushes increases significantly when they rotate.*

*See also Power, Speed and Pressure paragraph, since diameter and angular velocity are related.*

*SIT manufactures brushes with an OD from 1mm - 0.04" to 1000mm - 40". In our catalogue the user will find the product range recommended for each type of application and product type.*

### 4 Scegliere il diametro del filo / Choosing the filament diameter

Il diametro del filo influenza sensibilmente l'aggressività della spazzolatura sulla superficie di applicazione e il tipo di finitura ottenibile.

Fili sottili sono più flessibili e penetranti e resistono maggiormente alla fatica, ma sono meno aggressivi. Aumentando il diametro del filo, aumenta l'aggressività, ma anche la rigidità e quindi la suscettibilità a rottura.

Questa è la ragione fondamentale per la quale dovremmo cercare di utilizzare sempre il filamento più sottile possibile per l'operazione di spazzolatura, compatibilmente con la finitura desiderata.

SIT offre filamenti di diametro da 0,10mm - 0,004" a 2,5mm - 0,1" in una gamma che copre quasi tutte le applicazioni di spazzolatura possibile, per ottenere una finitura leggera o per attuare un'asportazione più pesante. Altre dimensioni sono disponibili su richiesta per applicazioni speciali.

*Wire size greatly influences surface brushing aggressiveness and the obtainable finishing.*

*Thin filaments are more flexible and have higher fatigue resistance but they are less aggressive. A bigger diameter gives higher aggressiveness but also susceptibility to breakage.*

*This is why you should always try to use the thinnest filament possible compatibly with the desired finishing.*

*SIT offers filling materials with diameter from 0,10mm - 0,004" to 2,5mm - 0,1" and a product range that covers almost all of the possible brushing applications, from a light finishing to a heavy removal. Special sizes for special applications are available upon request.*

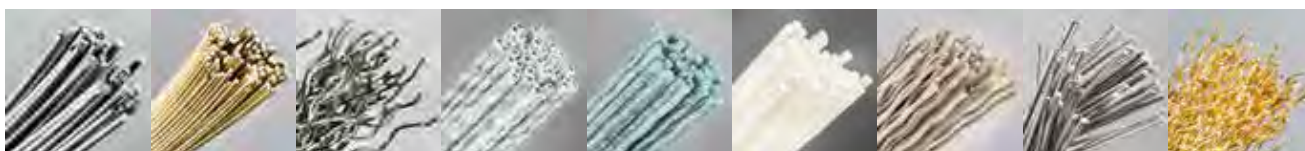

## 5 Scegliere lo stile del filo / Choosing the wire style

Lo stile del filo indica il modo con il quale il filamento viene trasformato prima di essere assemblato nella forma caratteristica della spazzola (tazza, circolare, ...). Si possono distinguere 3 stili di filo sia per i filamenti metallici sia per i filamenti sintetici:

The wire style indicates how the filament is processed before being assembled in the brush shape (cup, wheel...). There are 3 styles for both metallic and synthetic filaments:

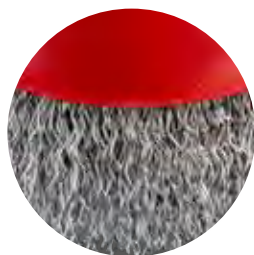

### Filo ondulato

Il filo ondulato ha un'azione meno aggressiva ed è caratterizzato da massima flessibilità e voluminosità. È quindi ideale per rimuovere rivestimenti come vernici e spessori leggeri, bave, incrostazioni e ruggine. Una variazione della frequenza e dell'ampiezza dell'onda nell'ondulazione del filo comporta il conferimento di una densità differente nella formazione della spazzola e quindi una performance differente. Solo un produttore di esperienze pluriennale è in grado di modulare queste variabili per creare un prodotto di qualità garantita e di massima prestazione.

### Crimped wire

Crimped wire has lower aggressiveness and maximum flexibility and bulkiness. It is ideal for the removal of coatings such as paint, light coatings, small burrs, incrustations and rust. Wave frequency and crimping amplitude give different density to the brush which leads to a different performance. Only a manufacturer with several years of experience can work these variables in a brush thereby creating a product of guaranteed quality and performance.



### Mazzetti ritorti

Il filo assieme in mazzetti ritorti nasce da un cordone di fili lisci che vengono avvolti ad elica per ottenere una maggiore aggressività. È consigliabile il suo utilizzo per lavori di asportazione intensa come la rimozione di rivestimenti superficiali di tubi ma anche la pulizia delle saldature da scorie superficiali, la preparazione alle passate successive e applicazioni da fonderia. Esistono alcune tipologie di mazzetto ritorto:

### Twist knots

Twist knots are made of many straight single wires twisted in a helix formation to achieve higher aggressiveness. They are suitable for heavy duty removal operations, such as pipe coating removal, weld cleaning and weld preparation for further processing and foundry applications.

There are different kinds of twist knots:

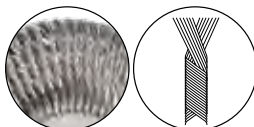

Standard twist (SF) - Media aggressività e flessibilità. Ideale per una buona penetrazione sul pezzo da trattare  
Standard twist (SF) - medium aggressiveness and flexibility. Ideal for good penetration on the part

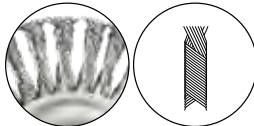

Cable twist (K) - Alta aggressività, limitata flessibilità. Ideale per le asportazioni pesanti (ad esempio rimozione dei rivestimenti dei tubi nell'industria del pipeline)  
Cable twist (K) - high aggressiveness and low flexibility. Ideal for heavy removal (pipe coatings removal in the pipeline industry)

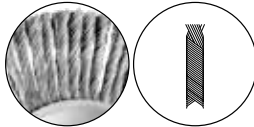

Stringer Bead twist (C) - Alta aggressività concentrata in piccola larghezza di fascia ottenuta con forte trazione nell'avvolgimento del filo. Ideale per lavorazioni pesanti in spazi limitati come gole o fessure (ad esempio preparazione e pulizia di passate di saldatura intermedie entro il cianfrino).  
Stringer bead twist (C) - high aggressiveness concentrated in a thinner band obtained by strong traction during the wire wrapping. Ideal for heavy duty operations in tight spaces such as grooves and cracks (e.g. weld preparation and cleaning within chamfers)

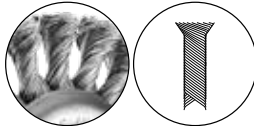

Vortex twist (V) - Estremità dei mazzetti con avvitamento quasi su un piano. Limitata penetrazione sul pezzo. Indicata per asportazione superficiale poco profonda (applicazioni più leggere delle altre tipologie di mazzetto ritorto)  
Vortex twist (V) - Flat twisting of the wire tips. Low penetration on the part; ideal for light removal operations (lighter operations than other twist knot types).

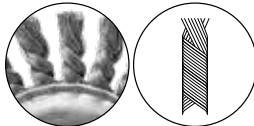

Rope twist (R) - Alta aggressività con doppio avvolgimento del mazzetto, concentrato in fascia di spazzolatura medio-alta. Ottimale in combinazione con filo temprato, registrando prestazioni 3,5 superiori rispetto ad un avvolgimento di tipo Vortex Twist.  
Rope Twist (R) - High aggressiveness with double twisting of the wire tips, concentrated in medium-high brushing band. Optimal in combination with hardened wire, records performances up to 3.5 times higher than the Vortex Twist range.

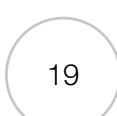

### Cordicella ottonata Liz

La cordicella ottonata LIZ è composta da molteplici filamenti singoli intrecciati tra loro, a volte con un “vergolino” di contenimento esterno. Questo stile rende il filamento molto resistente e nel contempo flessibile perché i capi dei fili mantengono la loro flessibilità, conferendo alle spazzole in cordicella la caratteristica di buona finitura superficiale. I filamenti in acciaio al carbonio di elevata qualità con rivestimento superficiale di ottone possono avere un diametro sottile (da Ø 0,17mm - 0.0067” a 0,20mm - 0.0078”) o grosso (da Ø 0,25mm - 0.010” a 0,35mm - 0.014”) a seconda del “pattern” desiderato. Ciò fa sì che venga particolarmente ricercato ed applicato per la spazzolatura di superfici in gomma.

#### Liz steel cord

*Liz steel cord is made up of multiple crimped filaments twisted or wrapped together, sometimes with another retaining filament. This configuration improves the bending stiffness of the wire giving the surface a unique finish. Liz increases brushing efficiency through maximum contact of filaments on the surface and improves the brush grinding performance and lifetime.*

*The single brass plated steel wire can be thinner (Ø 0,17mm - 0.0067” to 0,20mm - 0.0078”) or thicker (Ø 0,25mm - 0.010” to 0,35mm - 0.014”) depending on the desired “pattern”. This makes this filament widely applied in rubber treatment industry.*



### Multi-Filament

Composto da molteplici filamenti sintetici avvolti e tenuti insieme con speciali resine. Questa configurazione, simile alla cordicella Liz per i filamenti metallici, migliora l'effetto di spazzolatura sulla superficie per il maggiore adattamento dei singoli fili ed incrementa le performance/capacità di asportazione consentendo l'applicazione di una pressione maggiore sulle estremità del filamento.





A seconda delle applicazioni il Multi-Filament può essere composto da filamento sintetico puro, o sintetico abrasivo con grana da 1000 a 80, o come mix di filamenti sintetici puri ed abrasivi.

#### Multi-Filament

*Composed by multiple synthetic filaments wrapped and glued together with special resin. This configuration, similar to Liz for metallic wires, improves the brushing effect since filaments adapt on the surface and increases performance and grinding capacity since it allows higher pressure/load applied on the tips of the brush filaments.*

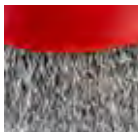
*Depending on the application, Multi-Filament can be composed of pure synthetic, synthetic with abrasive grit from 1000 to 80, or mixture of pure and abrasive filament.*

## GLI STILI DI FILO IN SINTESI / WIRE STYLES

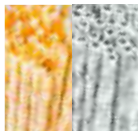
STILE DEL FILO WIRE STYLE	APPLICAZIONI APPLICATIONS	VANTAGGI ADVANTAGES
 <b>Filo Ondulato</b> <b>Crimped wire</b>	<p>È particolarmente indicato per lavori leggeri, rimozione di piccole scorie e ruggine, sbavatura leggera (sbavatura ingranaggi) e sbavature delle testate dei tubi.</p> <p><i>Ideal for light-duty operations such as paint, rust, scales, light coatings (deburring gear splines) and small burrs removal; light deburring and pipe heads deburring.</i></p>	<ul style="list-style-type: none"> <li>Alto carico di rottura <i>High tensile strength</i></li> <li>Indicato per alte velocità di rotazione <i>Suitable for high rotational speeds</i></li> <li>Lunga durata <i>Long lifetime</i></li> <li>Convenienza costo/durata <i>Cost/lifetime convenience</i></li> </ul>
 <b>Mazzetti Ritorti</b> <b>Twist knots</b>	<p>Azione più aggressiva del filamento ondulato, per lavori pesanti. Preparazione e pulizia cordoni di saldatura (es. tubi saldati di testa), sbavatura testate tubi di grande diametro, sbavatura di bave consistenti.</p> <p><i>More aggressive than crimped wire, suitable for heavy-duty jobs. Weld preparation and cleaning (butt-welded pipes), large pipe heads deburring, heavy burrs removal and foundry applications.</i></p>	<ul style="list-style-type: none"> <li>Elevata aggressività <i>High aggressiveness</i></li> <li>Lunga durata <i>Long lifetime</i></li> </ul>
 <b>Cordicella LIZ</b> <b>Liz steel cord</b>	<p>Indicata per applicazioni di lavorazione superfici in gomma (ricostruzione pneumatici, rasatura e riparazione della carcassa) ma anche per spazzolatura legno e sbavatura tubi.</p> <p><i>Ideal for operations on rubber surfaces (tyre retreading, buffing and casing repairing) but also for wood brushing and pipe deburring.</i></p>	<ul style="list-style-type: none"> <li>Elevatissimi carichi di rottura <i>High tensile strength</i></li> <li>Ottima stabilità dimensionali <i>Great dimensional stability (size retention)</i></li> </ul>
 <b>Sintetico Liscio</b> <b>Smooth synthetic filament</b>	<p>Ideale per pulizia di superfici delicate e per la tenuta di aria, polveri, umidità e temperatura (spazzole lineari Strip).</p> <p><i>Suitable for soft surfaces cleaning, protection and sealing from air, dust, moisture and temperature (Strip linear brushes).</i></p>	<ul style="list-style-type: none"> <li>Ottima finitura <i>Great finishing</i></li> <li>Densità ottimali <i>Optimal density</i></li> <li>Stabilità dimensionale <i>Dimensional stability (size retention)</i></li> </ul>
 <b>Sintetico Ondulato</b> <b>Crimped synthetic filament</b>	<p>Operazioni di rimozione di polveri pesanti e detriti.</p> <p><i>Suitable for the removal of heavy dust and debris.</i></p>	<ul style="list-style-type: none"> <li>Resistenza elevata <i>High resistance</i></li> <li>Ottima rigidità <i>Great stiffness</i></li> </ul>
 <b>Multi-Filament</b>	<p>Applicazioni tecniche che richiedono alte velocità e carichi di lavoro, particolari assorbimenti di liquidi (blank washing) o pulizia da residui oleosi. Industria trattamento coil e lamiera (laminazione, automotive, aerospaziale), industria del vetro (lavaggio e satinatura) e stamperia (pulizia rulli e pannelli).</p> <p><i>Technical applications requiring high speed and high brush load, high liquid absorption (blank washing), oily or greasy surfaces cleaning. Flat metal industries (rolling mills, automotive and aircraft), glass industry (washing and polishing) and printing industry (printing rolls and panels cleaning).</i></p>	<ul style="list-style-type: none"> <li>Minore usura (minore stress di flessione) <i>Wear reduction (less bending stress)</i></li> <li>Lunga durata <i>Long lifetime</i></li> <li>Ottima capacità di asportazione <i>High grinding capacity</i></li> <li>Finitura omogenea e regolata <i>Homogeneous and controlled finishing</i></li> <li>Capacità di rimuovere polveri microscopiche <i>Cleaning of microscopic dust capacity</i></li> </ul>

## 6 Scegliere la densità del filo / Choosing the fill density

La densità del filo influenza la "durezza" della superficie spazzolante: più denso è il filo, più aggressivo è l'effetto, in quanto - a parità d'area - si ha un numero maggiore di singoli utensili lavoranti. Spazzole dense sono caratterizzate da una minore capacità di penetrazione nella superficie e tendono meno ad aprirsi durante l'uso. La densità influenza inoltre la vita utile della spazzola, dal momento che il lavoro è "diviso" tra più punte di filo accostate e meno "deformabili". Nella spazzola più densa però si concentra e accumula più calore generato per attrito, esponendo a maggiore rischio di surriscaldamento le superfici spazzolate.

Nella sbavatura di tubi, ad esempio, sono previste spazzole a rullo di maggiore o minore densità a seconda del diametro e dello spessore del tubo da sbavare. Dimensioni diverse richiedono diversi requisiti di penetrazione entro ed attorno alla cavità circolare.

Filament density affects the "hardness" of the brush surface: the thicker the wire, the harder the surface since there is a greater number of individual working tips (for a set area). High density brushes are characterized by lower penetration into the surface and smaller opening during processing. Fill density also affects the service life; distributing the brushing action among multiple tips of wire makes each filament less deformable. On the other hand, high density brushes accumulate greater frictional heat, therefore increasing the risk of overheating the brushed surface.

For example, pipes deburring operations require roller brushes made of different filling density depending on the diameter and the thickness of the pipe. Different sizes and thickness need different level of interference.

## 7 Scegliere la sporgenza del filo / Choosing the trim length

La sporgenza del filo influenza la rigidità del complesso dei fili e quindi la durezza della spazzola: all'aumentare della sporgenza del filo aumentano la flessibilità e la capacità di penetrazione nella superficie da trattare. Sporgenze limitate aumentano la vita di servizio della spazzola perchè la deformazione del filo è ridotta, c'è quindi minore sollecitazione a fatica e il filamento non si spezza.

Nelle lavorazioni che avvengono ad interferenza o penetrazione "regolata" (costante durante la spazzolatura in valore assoluto, non relativo alla sporgenza), selezionare sporgenze troppo ridotte implica l'uso di spazzole "rigide" ed il ricorso a pressioni elevate per ottenere la penetrazione voluta: ne risulta un'elevata aggressività di spazzolatura ma ciò significa esporre il filo alla rottura a fatica. Conviene piuttosto, a pari velocità di rotazione, optare per sporgenze maggiori e raggiungere la penetrazione voluta con minore carico, l'aggressività sarà inferiore ma la durata della spazzola ne sarà di gran lunga avvantaggiata.

The trim length affects the stiffness of the filaments and the hardness of the brushing surface: a longer trim length improves the flexibility and the penetration of the part. A lower trim length improves the lifetime: there is lower wire deformation which means lower mechanical stress and lower risk of wire breakage.

In case of applications with fixed pressure (constant during the application, as an absolute value, not related to the trim length) choosing short trim length will require the use of stiff brushes and working with high pressures in order to obtain the desired penetration. The brushing system is very aggressive but the filament is susceptible to fatigue breakage.

For a set angular velocity it's better to choose longer trim length in order to obtain the desired penetration (interference) with less pressure/load; the brushing system will be less aggressive but it will have a longer lifetime and a better performance.

- + flessibilità / flexibility
- + capacità di penetrazione (interferenza) / penetration (interference)
- + deformazione del filo / wire deformation
- + velocità periferica = + energia = + efficienza / peripheral speed = + energy = + efficiency
- + vibrazioni e rischio di surriscaldamento / vibration and overheating
- + pressione utilizzabile / applicable pressure
- rischio di rottura a fatica / fatigue failure risk

## 8 Potenza, velocità e pressione / Power, speed, pressure

Gli aspetti che hanno sin qui guidato la scelta della spazzola devono essere valutati in dipendenza delle caratteristiche (potenza, pressione e velocità) della sorgente di energia utilizzata, poiché influiscono sulla finitura della superficie (una maggiore pressione allarga il fronte della spazzola e produce una finitura più omogenea). L'insieme dei parametri di funzionamento e delle caratteristiche della spazzola determina il risultato della lavorazione superficiale. Tale risultato va inteso in termini sia di qualità della lavorazione eseguita sul materiale, sia di resa del processo: non sempre i due esiti vanno d'accordo!

Ricordiamo che le spazzole, a differenza di mole, ruote lamellari e simili, non agiscono per abrasione, ma per vero e proprio "taglio". Sono utensili da impatto, le estremità dei cui fili asportano milioni di minuscoli trucioli, che si tratti di ruggine, vernice o altri residui. Rispetto agli utensili abrasivi producono un'azione più delicata e presentano minor rischio di tagliare in profondità, compromettendo la precedente finitura della superficie lavorata.

Topics and variables considered until this point have to be evaluated together with the characteristics (power, speed and pressure) of the source of power since these have a strong influence on the surface finishing (for example, a higher pressure will increase the face width of the brush obtaining a smoother surface finish). Brush characteristics together with operating parameters will determine the output of the surface treatment job. The surface finish has to be evaluated in terms of operational quality and efficiency: they are not always matching!

Unlike a coated abrasive wheel, a wire brush isn't a metal removal tool. Wire brushes are "impact" or "cutting" tools made up of thousands of wire tips attacking the surface to remove the adherence - be it rust, paint, oxidation, burr or anything else - in million of small parts. Also unlike coated, bonded, or nonwoven abrasive tools, power brushes work with lower risk of cutting deeply the part changing its shape and/or damaging previous finishing.

## Seguire poche buone pratiche può aiutare a coniugare qualità della finitura superficiale e vita utile della spazzola

**PRIMA REGOLA:** lavorare con pressione leggera, in modo che solo le punte dei fili vengano a contatto con la superficie di lavoro: esercitando il massimo urto, asportando le asperità velocemente e senza spezzarsi. Nella maggior parte dei casi, il corretto meccanismo d'asportazione si ottiene se non si superano interferenze di lavoro del 2-3% del raggio e pressioni dell'ordine di 0,2 - 0,5 Mpa (2 - 3 bar).

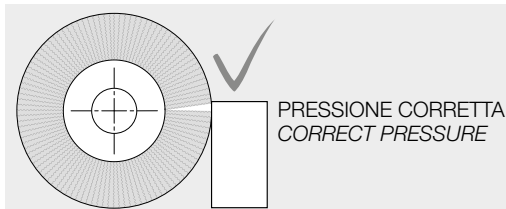

## Following few best practices will help obtaining the desired surface finish whilst achieving lifetime durability

**FIRST RULE:** work with light pressure, so that only the tips of the filament do the work. This way the impact among the filament and the part is precise and the material is removed quickly without damaging the wire. A rule of thumb is keeping a working interference of 2-3% of the radius and pressure around 0.2 - 0.5 MPa (2-3 bar)

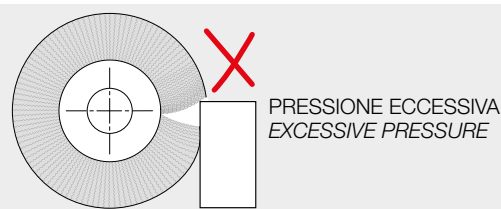

**SECONDA REGOLA:** è importante che, per le varie applicazioni, venga utilizzata la velocità lineare/periferica (delle estremità dei fili) ottimale per la buona riuscita della finitura della superficie da spazzolare e per non compromettere le proprietà del filamento (Tabelle 1 e 2). Ricordando quanto detto al passo 3, si sceglie il diametro della spazzola che, alla massima velocità consentita dall'utensile disponibile, comunque inferiore al valore ammissibile indicato a catalogo, fornisca la velocità periferica giusta per l'applicazione richiesta.

**SECOND RULE:** It's important to use the proper peripheral speed (at the wire tips) recommended for each and every application avoiding damage to filling material properties. Our studies and our experience resulted in the data displayed below (Tables 1 and 2). As written in Step 3, choose the largest diameter for the recommended peripheral speed compatible with the available tool and the maximum safe operating speed.

**Tabella / Table 1:**  
**Filamento Metallico / Metallic Wire**

Velocità periferiche [m/s o ft/min] per spazzolatura con spazzole circolari, a tazza e coniche di filo metallico.

Recommended peripheral speed [m/s or ft/min] for steel wire wheel, cup and bevel brushes.

APPLICAZIONE	m/s	10	15	20	25	30	35	40	45	50	80
APPLICATIONS	ft/min	1980	2940	3960	4920	5880	6900	7860	8880	9840	15720
Sbavare e raggiare Deburring and Radiusing			-	-				*	*		
Pulire saldature Weld cleaning						-	-				*
Scrostare, Decapare, Sverniciare e Rimuovere Ruggine Descaling, Pickling, Rust and paint removal					-	-				*	
Rusticare, Strutturare, Irruvidire Structuring, Forming, Roughening				-					*		
Pulire, Spolverare e Lucidare Cleaning, Dusting and Polishing				-					*		
Trattare superfici plastiche Treating plastic surface		-			*						

\* estensione per gli acciai più duri avvolti in mazzetti e spazzole vulcanizzate / extensions for strong metals (twist knots wire and encapsulated brushes).

- estensione per metalli più dolci (acciai inox e metalli non ferrosi) / extension for light metals (S-Steel and non-ferrous metals).

**Tabella / Table 2:**  
**Filamento Sintetico / Synthetic Filament**

Velocità periferiche [m/s o ft/min] per spazzolatura con spazzole circolari di filo sintetico abrasivo e non.

Recommended peripheral speed [m/s or ft/min] for synthetic filament wheel brushes.

APPLICAZIONE	m/s	10	15	20	25	30	35	40	45	50	80
APPLICATIONS	ft/min	1980	2940	3960	4920	5880	6900	7860	8880	9840	15720
Sbavare e raggiare Deburring and Radiusing										+	
Scrostare, Decapare, Sverniciare e Rimuovere Ruggine Descaling, Pickling, Rust and paint removal									+		→
Rusticare, Strutturare, Irruvidire Structuring, Forming, Roughening											
Pulire, Spolverare e Lucidare Cleaning, Dusting and Polishing											
Sbavare materiale composito Deburring composite material											→

+ estensione in presenza di liquido lubrorefrigerante / extensions with coolant.

→ estensione ad oltre 50m/s - 9840 ft/min con fili abrasivi HT150/250 / extension over 50m/s - 9840 ft/min with abrasive filaments HT150/250.



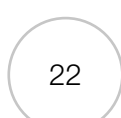

Identificata la velocità periferica, si possono scegliere, come riportato nel passo 3, il diametro e la velocità di rotazione compatibili. Si riporta di seguito la formula, con tabella dei risultati, per risalire, nota la velocità lineare periferica desiderata, alla velocità di rotazione della spazzola e il suo diametro ottimali.

Once the peripheral speed is identified, as explained in Step 3, we should choose compatible diameter and angular velocity dictated by the available tool.

Below the table to match the desired peripheral speed with the brush angular velocity and recommended diameter.

### Relazione tra Diametro, Velocità periferica (angolare) e RPM / Relationship between Diameter, Peripheral (angular) speed and RPM

$$v [m/s] = \frac{\text{Diametro spazzola / Brush diameter (D)} \cdot \pi \cdot \text{N}^\circ \text{ giri al minuto / Revolutions Per Minute (RPM)}}{1000 \cdot 60}$$

### VELOCITÀ / SPEED RPM

RPM	Diametro [mm]	40	50	80	100	125	150	180	200	250	300	350
	Diametro [inch]	1.5"	2"	3"	4"	5"	6"	7"	8"	10"	12"	14"
800	800	1.7	2.1	3.3	4.2	5.2	6.3	7.5	8.4	10.5	12.6	14.7
1000	1000	2.1	2.6	4.2	5.2	6.5	7.9	9.4	10.5	13.1	15.7	18.3
1200	1200	2.5	3.1	5.0	6.3	7.9	9.4	11.3	12.6	15.7	18.8	22.0
1500	1500	3.1	3.9	6.3	7.9	9.8	11.8	14.1	15.7	19.6	23.6	27.5
2000	2000	4.2	5.2	8.4	10.5	13.1	15.7	18.8	20.9	26.2	31.4	36.6
3000	3000	6.3	7.9	12.6	15.7	19.6	23.6	28.3	31.4	39.3	47.1	55.0
3500	3500	7.3	9.2	14.7	18.3	22.9	27.5	33.0	36.6	45.8	55.0	64.1
4000	4000	8.4	10.5	16.7	20.9	26.2	31.4	37.7	41.9	52.3	62.8	73.3
5000	5000	10.5	13.1	20.9	26.2	32.7	39.3	47.1	52.3	65.4	78.5	91.6
6000	6000	12.6	15.7	25.1	31.4	39.3	47.1	56.5	62.8	78.5	94.2	109.9
8000	8000	16.7	20.9	33.5	41.9	52.3	62.8	75.4	83.7	104.7	125.6	146.5
10000	10000	20.9	26.2	41.9	52.3	65.4	78.5	94.2	104.7	130.8	157.0	183.2
12500	12500	26.2	32.7	52.3	65.4	81.8	98.1	117.8	130.8	163.5	196.3	229.0
15000	15000	31.4	39.3	62.8	78.5	98.1	117.8	141.3	157.0	196.3	235.5	274.8

$$1\text{m} = 3,28\text{ft} - 1\text{ m/s} = 197\text{ ft/min}$$



### ESEMPIO / EXAMPLE

**LAVORO:** pulire da scorie superficiali le passate intermedie di saldatura in cianfrino mediante spazzole circolari di filo d'acciaio "high tensile" a mazzetti ritorti, disponendo di smerigliatrici angolari di varia dimensione

**REQUIRED JOB:** removal of shallow slags from weld within chamfers, using twist knots wheel brushes with high tensile steel wire and angle grinders with different size

1. Si parte individuando da Tabella 1 (pag. 21) in 80m/s - 15750 ft/min la velocità periferica lineare massima raccomandata: il massimo diametro disponibile per la tipologia UZ a mazzetti ritorti "stringer bead" è Ø178mm - 7";

1. Let's start finding in Table 1 (page 21) the maximum recommended linear speed: 80m/s - 15750 ft/min. In the catalogue we find the maximum available outer diameter for the UZ stringer bead twist knot wheel: Ø 178mm - 7"

2. Corrispondentemente, si verifica la compatibilità di montaggio su smerigliatrici angolari tenendo in considerazione anche il valore di MAX RPM della spazzola che deve essere superiore di quello della smerigliatrice. Le dimensioni di smerigliatrice angolare possono essere di Ø 180mm - 7" (MAX RPM 8500) o Ø 230mm - 9" (MAX RPM 6500).

2. At the same time we check the compatibility between this brush size and the angle grinder size considering also the MAX RPM value of the grinder that has to be lower than the one of the brush. The available dimensions for angle grinders are Ø 180mm - 7.1" (MAX RPM 8500) or Ø 230mm - 9" (MAX RPM 6500).

3. Poiché la smerigliatrice per i dischi maggiori comporta velocità periferica delle UZ178...

3. If we choose the bigger grinder (Ø 230mm - 9") we would have a peripheral speed of the UZ178 of

$V = (178 * 3,14 * 6500) / 1000 * 60 = 60,5\text{ m/s} = 11910\text{ ft/min}$   
...la scelta dell'elettrotensile ricade sulla smerigliatrice per dischi Ø 180mm - 7" che consente di realizzare la velocità...

$V = (178 * 3,14 * 8500) / 1000 * 60 = 79,2\text{ m/s} = 15590\text{ ft/min}$   
If we choose the smaller grinder (Ø 180mm - 7") we would have a peripheral speed of the UZ178 of

$V = (178 * 3,14 * 8500) / 1000 * 60 = 79,2\text{ m/s} = 15590\text{ ft/min}$   
...molto prossima al valore ottimale  
Essendo poi la spazzola UZ178 caratterizzata da MAX 12500 RPM, la scelta è largamente confermata anche in termini di resistenza alla forza centrifuga

...very close to the highest recommended value (from the table).  
Since the MAX RPM value for the UZ178 is 12500 the choice is confirmed even from the safety point of view (centrifugal force).

4. In corrispondenza di pressione e velocità lineare di servizio, è infine possibile associare la potenza meccanica necessaria da applicare all'albero di rotazione spazzola per eseguire la regolarizzazione superficiale del cordone di saldatura. Si deduce orientativamente il dato...

4. With a set pressure and linear speed we can calculate the mechanical power needed for the spindle where the brush for the weld cleaning is mounted.

$P = V * F * \mu = 79,2 * 50 * 0,5 / 1000 = 1,98\text{ kW}$   
Dove V = velocità tangenziale, F = Forza/spinta stimata di 50 Newton esercitata sulla superficie,  $\mu$  = Coefficiente d'attrito stimato genericamente.

$P = V * F * \mu = 79,2 * 50 * 0,5 / 1000 = 1,98\text{ kW}$   
Where V = tangential velocity/peripheral speed, F = Force, estimated of 50 Newton applied on the surface,  $\mu$  = Attrition coefficient from a general estimate

Si ottiene dunque una Potenza P compatibile con servizio discontinuo di un elettrotensile di potenza nominale 2,1 kW, tipica della taglia selezionata

So we have a Power P compatible with an intermittent working of the power tool with a nominal power of 2.1 kW, common for the selected tool size.

# TECH

## Quando scegliere una spazzola TECH *When you need a TECH brush*

Come specialista nel mondo della finitura superficiale, SIT offre una gamma di prodotti ampia e completa che intende rispondere alle diverse esigenze dei propri clienti e utilizzatori. L'intera proposta è stata sviluppata tenendo alti e costanti gli standard di qualità, di sicurezza, di affidabilità e di usabilità. Per alcuni prodotti abbiamo voluto mettere alla prova la nostra capacità di innovare e di trovare nuove e più performanti soluzioni che assicurassero ulteriori livelli di qualità e di durata, particolarmente ricercati dai clienti e utilizzatori più esigenti. A questi prodotti abbiamo associato il bollino "TECH" e una confezione diversa nella grafica per poterli riconoscere, per facilitarne l'esposizione, per sottolinearne la specificità.

*As a specialist in the surface finishing industry, SIT offers a wide range of products that can fulfill every customer need. The whole range is engineered paying great attention to quality, safety, reliability and usability standards. We wanted to test our ability to innovate and find new and better performing solutions that would ensure additional levels of quality and durability for our products in order to satisfy our demanding customers. The "TECH" label and a different packaging distinguish these products, to facilitate their display and emphasise their specific utilisation & market.*

**Packaging  
ultra-resistente**

**Sfondo grigio  
"industriale"**

**Marchio TECH**

**Disegni tecnici per  
identificare la natura del  
prodotto**



**Ultra-resistant packaging**

**"Industrial" gray  
background**

**TECH label**

**Technical drawings to  
specify and identify the  
nature of the product**

Le spazzole TECH si distinguono per la maggiore densità di filamento, per la qualità dei materiali e per la presenza di elementi tecnici migliorativi della performance.

*TECH brushes are characterized by higher filling density, high quality materials and technical components for a better performance.*



**Maggiore densità di  
filamento / Higher  
filling density  
=  
performance fino  
a 3x / increased  
performance 3x**

**Presenza  
dell'anello di  
ritenuta / Bridle  
=  
maggiore durata /  
longer lifetime**



**PATENTED  
SOLUTIONS**

**Materiali e filamenti  
speciali come resina  
vulcanizzante su acciaio  
ondulato, ottone anti-  
scintilla e nylon abrasivo  
ceramico**

**Special filaments and  
materials such as rubber-  
bonded crimped wire,  
anti-sparkle brass and  
ceramic abrasive nylon.**

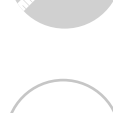

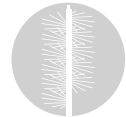

# SMERIGLIATRICE ANGLE GRINDER

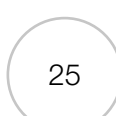

## SPAZZOLE A TAZZA / CUP BRUSHES

p. 26



> Spazzole a tazza a mazzetti ritorti  
*Twist knot cup brushes*

p. 27



> Spazzole a tazza in filo ondulato  
*Crimped wire cup brushes*

p. 30

## SPAZZOLE CONICHE / BEVEL BRUSHES

p. 33



> Spazzole coniche a mazzetti ritorti  
*Twist knot bevel brushes*

p. 34



> Spazzole coniche in filo ondulato  
*Crimped wire bevel brushes*

p. 35

## SPAZZOLE CIRCOLARI / WHEEL BRUSHES

p. 37



> Spazzole circolari a mazzetti ritorti  
*Twist knot wheel brushes*

p. 38



> Spazzole circolari in filo ondulato  
*Crimped wire wheel brushes*

p. 40



> Spazzole con attacco rapido  
Brushes for **XLOCK**

p. 41



> Box misti  
*Mixed Display boxes*

p. 42

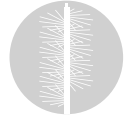

# > Spazzole a tazza / Cup brushes



www.sitbrush.tv/g1

## DISEGNI TECNICI / TECHNICAL DRAWINGS

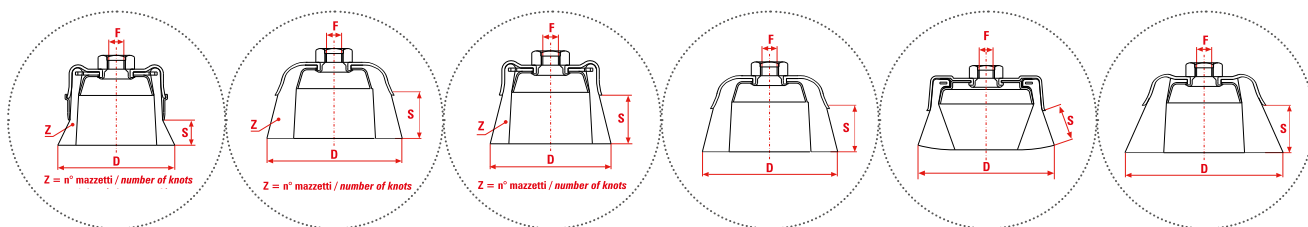

### LEGENDA PACK

<b>Single pack</b> e.g. 1/24 Confezione singola con eventuale imballo secondario da 24 pezzi / Single pack with 24-pcs secondary packaging (if any)	<b>Blister pack</b> e.g. B/6/48 Blister singolo in scatole da 6 pezzi con eventuale imballo secondario da 48 pezzi / Single blister pack in boxes containing 6pcs with 48-pcs secondary packaging (if any)	<b>Multipack</b> e.g. 12/96 Confezione multipla da 12 pezzi con eventuale imballo secondario da 96 pezzi / Multiple pack containing 12 pcs with 48-pcs secondary packaging (if any)

### LEGENDA FILO / FILAMENT

<b>Acciaio / Steel</b>	<b>Inox / Stainless Steel</b>	<b>Ottone / Brass</b>	<b>Cordicella d'acciaio Liz / LIZ Steel Cord</b>	<b>Nylon abrasivo / Abrasive Nylon</b>
<b>Acciaio ottonato / Brass Plated Steel</b>			<b>Cordicella d'acciaio inox Liz / LIZ S.Steel Cord</b>	<small>Filamenti in Nylon abrasivo: O.A. = Ossido di Alluminio C.S. = Carburio di Silicio Abrasive Nylon filaments: O.A. = Aluminium Oxide C.S. = Silicon Carbide</small>

## NOTE / NOTES

**Attacco multifiletto M14+5/8"**  
L'attacco multifiletto permette di montare le spazzole su utensili con boccia M14 e/o 5/8". Tutte le spazzole, a richiesta, possono montare l'attacco multifiletto.

**Multi-threaded nut M14+5/8"**  
The multi-threaded nut allows to mount brushes on M14 or 5/8" threaded tools. If required, the multi-threaded nut can be mounted on any brush.

**Riduzione M14 / M10**  
Adattatore aggiuntivo per collegare spazzole con dado filettato M14 su utensili con attacco M10.

**M14/M10 threaded adapter**  
Additional adapter suitable to mount brushes with M14 threaded nut on M10 threaded tools.

	<b>Ref</b>
1	<b>1059</b>



**Gli articoli con Ref ROSSA sono i più venduti / scelte consigliate**  
Items marked in RED are the best sellers / recommended choice

**L'anello di ritenuta può essere rimosso per utilizzare al massimo i filamenti.**  
The bridle can easily be removed enabling maximum utilisation of the wire.



**> Spazzole a tazza a mazzetti ritorti / Twist knot cup brushes**

**TU71**

**TU71 inox**

**TU71 ottone / brass**

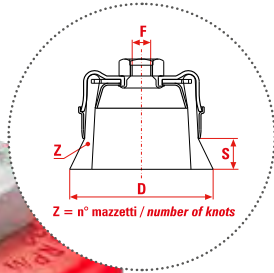

Robuste, aggressive e con la massima sicurezza di impiego. Montabili anche su macchinari fissi, manuali, automatici o CNC. Le TU71 in Acciaio e Acciaio Inox sono tra le spazzole più vendute ed apprezzate dai clienti di SIT in tutto il mondo.

Tough, aggressive and very safe in operations. Mountable on manual, automatic and CNC machinery. Steel and Stainless Steel TU71 brushes are among the most sold and highly rated brushes all over the world.

**Tazze per smerigliatrice con anello di ritenuta TU / Cup brushes for grinder with bridle TU**

D		F	S		Z	MAX RPM	2	ART	0,35mm	0,50mm	0,50mm	0,50mm
mm	inch		mm	inch					0,014"	0,020"	0,020"	0,020"
70	2-3/4	M14	17	5/8	18	14000	12/48	<b>TU71</b>	<b>0240</b>	<b>0242</b>		
70	2-3/4	M14	17	5/8	18	14000	1/24	<b>TU71</b>	<b>0241</b>	<b>0280</b>	<b>0936</b>	<b>0245</b>
70	2-3/4	M14	17	5/8	18	14000	B/6/48	<b>B TU71</b>	<b>0730</b>		<b>0935</b>	
70	2-3/4	M10	17	5/8	18	14000	B/6/48	<b>B TU71</b>	<b>0731</b>		<b>0943</b>	
70	2-3/4	M14+5/8"	17	5/8	18	14000	1/24	<b>TU71</b>			<b>2574</b>	
70	2-3/4	M14+5/8"	17	5/8	18	14000	12/48	<b>TU71</b>	<b>2591</b>			

- Le spazzole per smerigliatrice in confezionamento multiplo hanno etichetta barcode.

Each brush for grinder sold in multiple pack has its own barcode.



**APPLICAZIONI / APPLICATIONS**

Eliminare scorie, ruggine, vernici e forti incrostazioni da superfici di qualsiasi tipo di materiale.

Remove slags, rust, paint and hard incrustations from any kind of surface.

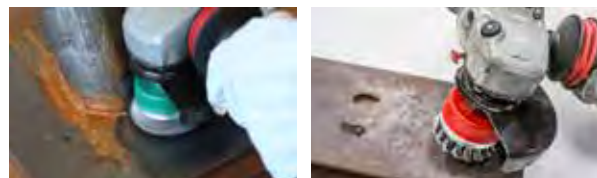

## > Spazzole a tazza a mazzetti ritorti / Twist knot cup brushes

TU85



TU131 inox

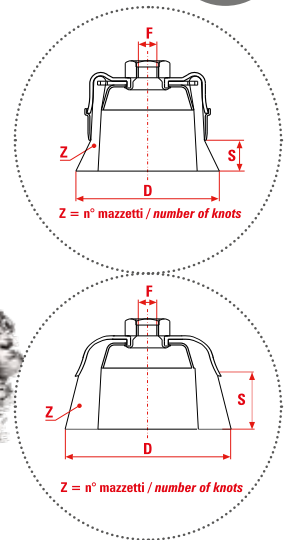

Robuste, aggressive e con la massima sicurezza di impiego. Montabili anche su macchinari fissi, manuali, automatici e CNC. Sono utilizzabili su smerigliatrici a giri variabili. Disponibili nelle versioni a doppio anello di mazzetti.

Tough, aggressive and very safe in operations. Mountable on manual, automatic and CNC machinery. They can be used on variable speed angle grinders. Available in the versions with double row of twist knots.

### Tazze con anello di ritenuta TU / Cup brushes with bridle TU

D		F		S		Z	MAX RPM		ART	0,35mm	0,50mm	0,80mm	0,50mm
mm	inch	mm	inch	mm	inch					0,014"	0,020"	0,031"	0,020"
85	3-3/8	M14 *		25	1	22	8500	1/18	TU85	0252	0253	0254	2333
95	3-3/4	M14 *		20	3/4	24	8500	1/18	TU101	0259	0260	0261	0937
95	3-3/4	M14+5/8"		20	3/4	24	8500	1/18	TU101	2595			2596
95	3-3/4	M14		20	3/4	24+18 *	6600	1/9	TU102		0268		
105	4-1/8	M14 *		25	1	26	8500	1/9	TU111	0269	0270	0271	0938
105	4-1/8	M14		25	1	26+22 *	6600	1/9	TU112			0276	
120	4-3/4	M14 *		27	1-1/8	32	6600	1/8	TU131	0277	0278	0279	0939
120	4-3/4	M14+5/8"		27	1-1/8	32	6600	1/8	TU131		2602		0927
125	5	M14		27	1-1/8	32+24 *	6600	1/8	TU132		0284		
150	6	M14		35	1-3/8	40+32 *	6000	1	TU152		2397		

### Tazze ad alta velocità TZ / High speed cup brushes TZ

D		F		S		Z	MAX RPM		ART	0,50mm	0,50mm
mm	inch	mm	inch	mm	inch					0,020"	0,020"
90	3-1/2	M14+5/8"		25	1	22	12200	1/18	TZ90	0334	0354

\*Disponibili anche a foro 22,2 - 7/8" / Also available with a 22.2mm - 7/8" hole

• TU102, TU112, TU132, TU152 due ranghi / two rows

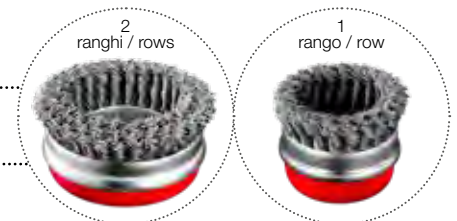

### APPLICAZIONI / APPLICATIONS

Eliminare scorie, ruggine, vernici e forti incrostazioni.  
Remove slags, rust, paint and hard incrustations.



**> Spazzole a tazza a mazzetti ritorti / Twist knot cup brushes**

**TZ70**



**TZ70 inox**



**TZ100**



La versione TZ comprende spazzole a tazza a mazzetti ritorti senza anello di ritenuta. Ciò le rende meno aggressive.

The TZ version includes twist knots cup brushes without a retaining ring. This makes them less aggressive versions.

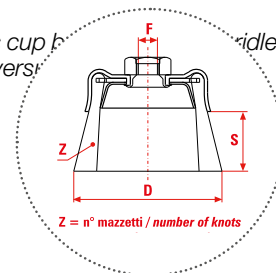

**Tazze TZ / Cup brushes TZ**

D		F		S		Z	MAX RPM		ART	0,35mm	0,50mm	0,50mm
mm	inch	mm	inch	mm	inch					0,014"	0,020"	0,020"
75	3	M14		20	3/4	18	14000	12/48	<b>TZ70</b>	<b>0325</b>	<b>0326</b>	<b>0332</b>
75	3	M14		20	3/4	18	14000	1/24	<b>TZ70</b>	<b>0323</b>		
75	3	M14+5/8"		20	3/4	18	14000	12/48	<b>TZ70</b>		<b>2567</b>	<b>0335</b>
75	3	M14		20	3/4	18	14000	B/6/48	<b>B TZ70</b>		<b>0740</b>	
100	4	M14*		25	1	22	8500	6/24	<b>TZ100</b>		<b>0328</b>	
100	4	M14		25	1	22	8500	B/6/24	<b>B TZ100</b>		<b>0320</b>	
120	4-3/4	M14*		25	1	26	8500	3/12	<b>TZ120</b>		<b>0330</b>	
120	4-3/4	M14		25	1	26	8500	B/6/18	<b>B TZ120</b>		<b>0322</b>	

\*Disponibili anche a foro 22,2 - Also available with a 22.2mm -7/8" hole

- Le spazzole per smerigliatrice in confezionamento multiplo hanno etichetta barcode.  
Each brush for grinder sold in multiple pack has its own barcode.



**APPLICAZIONI / APPLICATIONS**

Rimozione di ruggini e rivestimenti superficiali. Applicazioni più leggere della linea TECH.  
Removal of surface coatings. Lighter applications than TECH range.

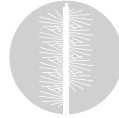
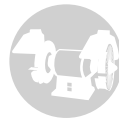

## > Spazzole a tazza in filo ondulato / Crimped wire cup brushes

T80



T80 ottone / brass



T80 Liz



T80 Liz  
Inox



NEW

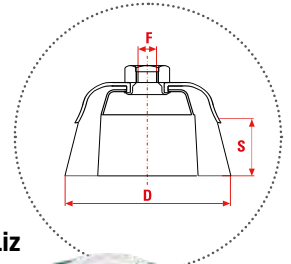

In filo ondulato ad alta resistenza. Ideali nella pulizia di superfici metalliche, legno, gomma, pietre e marmo. Utilizzabili anche in macchinari appositi.

Made of highly resistant crimped wire, they are ideal for cleaning metal surfaces, wood, rubber, stones and marble. They can also be used in specific machines.

### Tazze per smerigliatrice / Cup brushes for grinder

D		F	S		MAX RPM		ART	0,35mm	0,30mm	0,30mm	0,25mm	0,35mm
mm	inch		mm	inch				0,014"	0,012"	0,012"	0,010"	0,014"
60	2-3/8	M14	22	7/8	14000	12/48	<b>T60</b>	<b>0125</b>				
60	2-3/8	M10	22	7/8	14000	12/48	<b>T60</b>	<b>0126</b>				
60	2-3/8	M14+5/8"	22	7/8	14000	12/48	<b>T60</b>	<b>2543</b>				
80	3-1/8	M14	25	1	14000	10/40	<b>T80</b>	<b>0127</b>				
80	3-1/8	M14	25	1	14000	1/24	<b>T80</b>	<b>0128</b>	<b>0926</b>	<b>0130</b>	<b>9630</b>	<b>0154*</b>
80	3-1/8	M10	25	1	14000	10/40	<b>T80</b>	<b>0132</b>				
80	3-1/8	M14+5/8"	25	1	14000	1/24	<b>T80</b>	<b>2549</b>	<b>2551</b>			
80	3-1/8	M14	25	1	14000	B/6/48	<b>B T80</b>		<b>0925</b>			
80	3-1/8	M10	25	1	14000	B/6/48	<b>B T80</b>		<b>0942</b>			

\*LIZ Inox: Migliore finitura (grazie a filamento singolo più sottile) e performance estrema 3.5x (grazie alla struttura a cordicella) rispetto al normale filo ondulato  
LIZ S/Steel cord: Better finishing (thanks to thinner wires) and extreme 3.5x performance (thanks to the steel cord style) compared to standard crimped wire

### Tazze in Nylon abrasivo / Abrasive nylon cup brushes

D		F	S		MAX RPM		ART	0,90mm-0,037"	
mm	inch		mm	inch				C.S. gr 180	
80	3-1/8	M14	25	1	14000	1/24	<b>T80</b>	<b>0129</b>	
80	3-1/8	M14+5/8"	25	1	14000	1/24	<b>T80</b>	<b>0146</b>	

Nylon abrasivo / Abrasive Nylon

Attenzione alle velocità di rotazione consigliate per ogni applicazione: vedi tabella 2 pag. 21  
Pay attention to the recommended speed for each application: see table 2 page 21



T80 abrasive



- Le spazzole per smerigliatrice in confezionamento multiplo hanno etichetta barcode.

Each brush for grinder sold in multiple pack has its own barcode.

### APPLICAZIONI / APPLICATIONS

Sbavature leggere, satinature, pulizia di piccole scorie e ruggine, sbavature di testate di tubi.

Light deburring, satin finishing, removal of small slags and rust, deburring of pipe edges.



## > Spazzole a tazza in filo ondulato / Crimped wire cup brushes



T150



T120 Liz



T100 inox



T90 inox

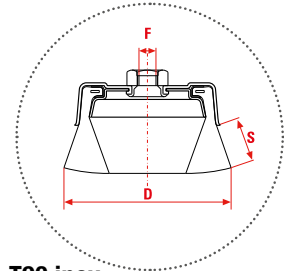

Tazze in filo ondulato ad alta resistenza. Ideali nella pulizia di superfici metalliche, legno, gomma, pietre e marmo. Utilizzabili anche in macchinari appositi.

Cup brushes made of highly resistant crimped wire, they are ideal for cleaning metal surfaces, wood, rubber, stones and marble. They can also be used in specific machines.

### Tazze ad alta velocità T / High speed cups T

D		F		S		MAX RPM	2	ART	0,35mm	0,30mm
mm	inch	mm	inch	mm	inch				0,014"	0,012"
90	3-1/2	M14+5/8"		25	1	12200	1/18	<b>T90</b>	<b>0123</b>	<b>0113</b>

### Tazze T / Cup brushes T

D		F		S		MAX RPM	2	ART	0,35mm	0,50mm	0,30mm	0,30mm	0,25mm
mm	inch	mm	inch	mm	inch				0,014"	0,020"	0,012"	0,012"	0,010"
100	4	M14		25	1	8500	1/18	<b>T100</b>	<b>0137</b>	<b>0138</b>	<b>0928</b>	<b>0140</b>	<b>9631</b>
100	4	22.2	7/8	25	1	8500	1/18	<b>T100</b>	<b>0141</b>		<b>0929</b>		
100	4	M14+5/8"		25	1	8500	1/18	<b>T100</b>		<b>2555</b>	<b>2556</b>		
100	4	M14		25	1	8500	B/6/48	<b>B T100</b>			<b>0930</b>		
120	4-3/4	M14		30	1-1/8	8500	1/16	<b>T120</b>	<b>0147</b>	<b>0148</b>	<b>0932</b>	<b>0150</b>	<b>9632</b>
120	4-3/4	22.2	7/8	30	1-1/8	8500	1/16	<b>T120</b>	<b>0152</b>		<b>0933</b>		
120	4-3/4	M14+5/8"		30	1-1/8	8500	1/16	<b>T120</b>	<b>2606</b>	<b>0149</b>	<b>2607</b>		
150	6	M14		30	1-1/8	6600	1/16	<b>T150</b>	<b>0158</b>	<b>0159</b>			
150	6	22,2	7/8	30	1-1/8	6600	1/16	<b>T150</b>	<b>0160</b>				

### Tazze in Nylon abrasivo / Abrasive nylon cup brushes

D		F	S		MAX RPM	2	ART	0,90mm-0,037"
mm	inch	mm	mm	inch				C.S. gr 180
100	4	M14	25	1	8500	1/18	<b>T100</b>	<b>0139</b>
120	4-3/4	M14	30	1-1/8	6600	1/16	<b>T120</b>	<b>0151</b>

**Nylon abrasivo / Abrasive Nylon**  
 Attenzione alle velocità di rotazione consigliate per ogni applicazione: vedi tabella 2 pag. 21  
 Pay attention to the recommended speed for each application: see table 2 page 21

- **T90** Fortemente aggressiva, Alta velocità, Alto rendimento.  
*Highly aggressive, high speed, high efficiency.*

### APPLICAZIONI / APPLICATIONS

Sbavature leggere, satinature, pulizia di piccole scorie e ruggine, sbavature di testate di tubi.  
*Light deburring, satin finishing, removal of small slags and rust, deburring of pipe edges.*



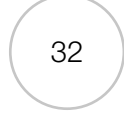
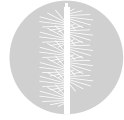

# SMERIGLIATRICE / ANGLE GRINDER

## > Spazzole a tazza in filo ondulato / Crimped wire cup brushes



Spazzole in filo d'acciaio ottonato ondulato per la pulizia di superfici. La versione TE comprende spazzole a tazza più leggere.

Brass plated crimped wire brushes for surface cleaning. The TE range includes lighter cup brushes.

### Tazze TE / Cup brushes TE

D		F		S		MAX RPM	Box Qty	ART	0,30mm
mm	inch	mm	inch	mm	inch				0,012"
60	2-3/8	M14		25	1	14000	12/48	TE60	0103
60	2-3/8	M14		25	1	14000	B/6/48	B TE60	0228
80	3-1/8	M14		25	1	14000	10/40	TE80	0105
80	3-1/8	M14		25	1	14000	B/6/48	B TE80	0725
85	3-3/8	22,2	7/8	25	1	14000	8/64	TE85	0124
100	4	M14		25	1	8500	5/40	TE100	0108
100	4	22,2	7/8	25	1	8500	5/40	TE100	0109
100	4	M14		25	1	8500	B/6/24	B TE100	0110
120	4-3/4	M14		30	1-1/8	6600	4/16	TE120	0118
120	4-3/4	M14		30	1-1/8	6600	B/6/24	B TE120	0120
150	6	M14		24	1	6600	3/12	TE150	0121

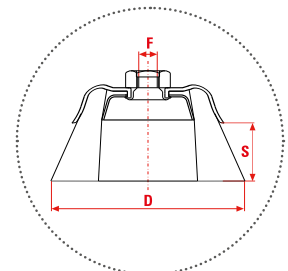

TE85



• Le spazzole per smerigliatrice in confezionamento multiplo hanno etichetta barcode.  
Each brush for grinder sold in multiple pack has its own barcode.

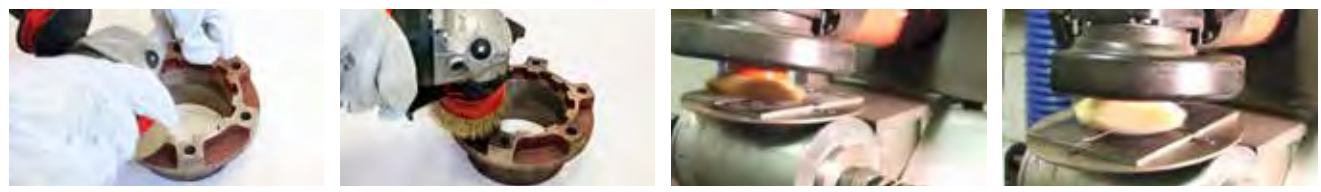

### APPLICAZIONI / APPLICATIONS

La maggiore flessibilità e la minore densità di filo le rendono adatte a lavori meno pesanti di pulitura, satinatura, finitura, rimozione di scorie. Possono essere usate su superfici metalliche, legno, pietra, gomma e marmo.  
The greater flexibility and lower wire density make them suitable for lighter jobs of cleaning, finishing, satin finishing and waste removal. They can be used on metallic surfaces, wood, rubber, stone and marble.

GUARDA IL VIDEO  
WATCH THE VIDEO

[sitbrush.tv/gtest](http://sitbrush.tv/gtest)







## > Spazzole coniche a mazzetti ritorti / Twist knot bevel brushes

CZ95

CZ95 inox

CZ120



La forma conica rende queste spazzole adatte a lavori "di taglio" su superfici irregolari, con spigoli, profili e fessure. I mazzetti ritorti ne fanno una spazzola aggressiva.

The conical shape makes these brushes suitable for sideways jobs on irregular surfaces, with edges, profiles and cracks. The twisted knots make them aggressive.

### Coniche CZ / Bevel brushes CZ

D		F	S		Z	MAX RPM		ART	0,50mm	0,50mm
mm	inch		mm	inch					0,020"	0,020"
95	3-3/4	M14	20	3/4	18	14000	12/48	<b>CZ95</b>	<b>0309</b>	
95	3-3/4	M14	20	3/4	18	14000	1/36	<b>CZ95</b>	<b>0308</b>	<b>0951</b>
95	3-3/4	M10	20	3/4	18	14000	1/36	<b>CZ95</b>	<b>0312</b>	
95	3-3/4	M14+5/8"	20	3/4	18	14000	1/36	<b>CZ95</b>	<b>2562</b>	<b>0948</b>
95	3-3/4	M14	20	3/4	18	14000	B/6/48	<b>B CZ95</b>	<b>0760</b>	<b>0950</b>
95	3-3/4	M10	20	3/4	18	14000	B/6/48	<b>B CZ95</b>	<b>0761</b>	<b>0949</b>
120	4-3/4	M14	22	7/8	18	12500	1/32	<b>CZ120</b>	<b>0315</b>	<b>2465</b>
120	4-3/4	M14+5/8"	22	7/8	18	12500	1/32	<b>CZ120</b>	<b>2563</b>	<b>2463</b>
150	6	M14	25	1	24	9000	1/16	<b>CZ150</b>	<b>0316</b>	<b>2464</b>

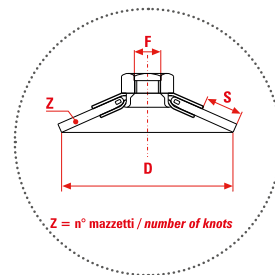

Z = n° mazzetti / number of knots

- Le spazzole per smerigliatrice in confezionamento multiplo hanno etichetta barcode.  
Each brush for grinder sold in multiple pack has its own barcode.



### APPLICAZIONI / APPLICATIONS

Rimozione di scorie, ruggine e residui da superfici di ogni materiale e forma.  
Waste, residues and rust removal from surfaces of any shape and material.



## > Spazzole coniche in filo ondulato / Crimped wire bevel brushes

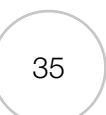

C090

C090 inox

C0120



La forma conica rende queste spazzole adatte a lavori “di taglio” su superfici irregolari, con spigoli, profili e fessure. In acciaio ondulato ad altissima resistenza.

The conical shape makes these brushes suitable for sideways jobs on irregular surfaces, with edges, profiles and cracks. Made of high resistance crimped wire.

### Coniche CO / Bevel brushes CO

D		F	S		MAX RPM	Box	ART	0,35mm	0,30mm	0,35mm
mm	inch		mm	inch				0,014"	0,012"	0,014"
90	3-1/2	M14	20	3/4	14000	12/96	<b>C090</b>	<b>0173</b>		
90	3-1/2	M14	20	3/4	14000	1/36	<b>C090</b>	<b>0172</b>	<b>0946</b>	<b>0178*</b>
90	3-1/2	M14+5/8"	20	3/4	14000	1/36	<b>C090</b>	<b>0171</b>	<b>0958</b>	
90	3-1/2	M14	20	3/4	14000	B/6/48	<b>B C090</b>		<b>0945</b>	
120	4-3/4	M14	22	7/8	12500	1/32	<b>C0120</b>	<b>0175</b>	<b>2430</b>	
120	4-3/4	M14+5/8"	22	7/8	12500	1/32	<b>C0120</b>	<b>2560</b>	<b>2429</b>	
150	6	M14	25	1	9000	1/16	<b>C0150</b>	<b>0176</b>	<b>2433</b>	

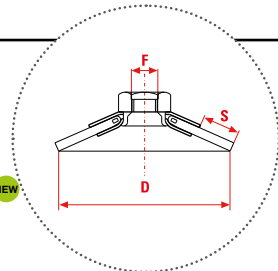

**IMPROVED PERFORMANCE**

\*LIZ Inox: Migliore finitura (grazie a filamento singolo più sottile) e performance estrema 3.5x (grazie alla struttura a cordicella) rispetto al normale filo ondulato  
LIZ S/Steel cord: Better finishing (thanks to thinner wires) and extreme 3.5x performance (thanks to the steel cord style) compared to standard crimped wire

- Le spazzole per smerigliatrice in confezionamento multiplo hanno etichetta barcode.  
Each brush for grinder sold in multiple pack has its own barcode.



### APPLICAZIONI / APPLICATIONS

Rimozione di scorie, ruggine e residui da superfici di ogni materiale e forma.  
Waste, residues and rust removal from surfaces of any shape and material.



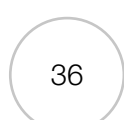
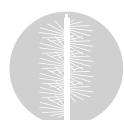

# SMERIGLIATRICE / ANGLE GRINDER

## > Spazzole coniche in filo ondulato / Crimped wire bevel brushes



Spazzole in filo d'acciaio ottonato ondulato, più leggere rispetto alla linea Tech.

Brass plated crimped wire brushes, lighter than the Tech line.

### Coniche CO / Bevel brushes CO

D		F	S		MAX RPM	2	ART	0,30mm
mm	inch		mm	inch				0,012"
90	3-1/2	M14	20	3/4	14000	12/96	<b>C090E</b>	<b>0106</b>
90	3-1/2	M14	20	3/4	14000	B/6/48	<b>B C090E</b>	<b>0745</b>
90	3-1/2	M10	20	3/4	14000	B/6/48	<b>B C090E</b>	<b>0746</b>
120	4-3/4	M14	35	1-3/8	12500	10/40	<b>C0120E</b>	<b>0112</b>
120	4-3/4	M14	35	1-3/8	12500	B/6/48	<b>B C0120E</b>	<b>0222</b>

- Le spazzole per smerigliatrice in confezionamento multiplo hanno etichetta barcode.  
Each brush for grinder sold in multiple pack has its own barcode.



### APPLICAZIONI / APPLICATIONS

La maggiore flessibilità e la minore densità di filo le rendono adatte a lavori meno gravosi.  
The greater flexibility and lower wire density make them suitable for lighter operations.



# > Spazzole circolari / Wheel brushes



GUARDA IL VIDEO  
WATCH THE VIDEO



[www.sitbrush.tv/g3](http://www.sitbrush.tv/g3)

## DISEGNI TECNICI / TECHNICAL DRAWINGS

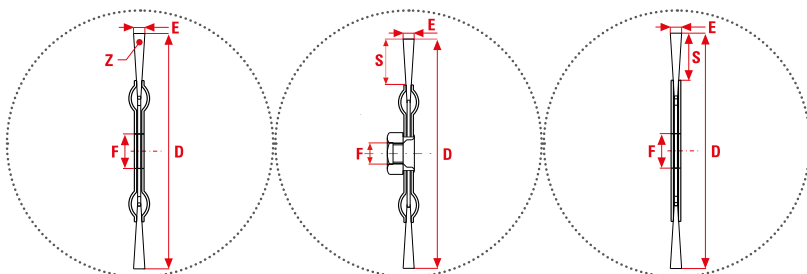

### LEGENDA PACK



#### Single pack e.g. 1/24

Confezione singola con eventuale imballo secondario da 24 pezzi / Single pack with 24-pcs secondary packaging (if any)

#### Blister pack e.g. B/6/48

Blister singolo in scatole da 6 pezzi con eventuale imballo secondario da 48 pezzi / Single blister pack in boxes containing 6pcs with 48-pcs secondary packaging (if any)

#### Multipack e.g. 12/96

Confezione multipla da 12 pezzi con eventuale imballo secondario da 96 pezzi / Multiple pack containing 12 pcs with 48-pcs secondary packaging (if any)

### LEGENDA FILO / FILAMENT



Acciaio / Steel

Inox / Stainless Steel

Acciaio ottonato / Brass Plated Steel

## NOTE / NOTES

Gli articoli con Ref ROSSA sono i più venduti / scelte consigliate  
Items marked in RED are the best sellers / recommended choice





## > Spazzole circolari a mazzetti ritorti / Twist knot wheel brushes



Spazzole adatte a lavori "di taglio" su superfici irregolari, con spigoli, profili e fessure. Aggressive, per lavori gravosi ad alte velocità di rotazione.

These aggressive brushes are suitable for sideways jobs on irregular surfaces, with edges, profiles and cracks and for heavy-duty jobs at high rotation speed.

### Circolari U / Wheel brushes U

D		F		E		S		Z	MAX RPM	ART	0,50mm 0,80mm 0,50mm		
mm	inch	mm	inch	mm	inch	mm	inch				0,020"	0,031"	0,020"
100	4	M14	10	3/8	20	3/4	18	20000	12/96	U100	0539	2061	
100	4	22,2	7/8	10	3/8	20	3/4	18	20000	12/96	U100	0540	2060
100	4	M14+5/8"	10	3/8	20	3/4	18	20000	12/96	U100	2581		
115	4-1/2	M14	10	3/8	23	7/8	20	20000	1/32	U115	0500		
115	4-1/2	M14	10	3/8	23	7/8	20	20000	12/48	U115	2013	0900	
115	4-1/2	22,2	7/8	10	3/8	23	7/8	20	20000	1/32	U115	0501	
115	4-1/2	22,2	7/8	10	3/8	23	7/8	20	20000	12/48	U115	2012	0901
125	5	M14	10	3/8	28	1-1/8	20	20000	10/40	U125	0506	2097	
125	5	22,2	7/8	10	3/8	28	1-1/8	20	20000	10/40	U125	0507	2096
125	5	M14+5/8"	10	3/8	28	1-1/8	20	20000	10/40	U125	0556	2099	
150	6	M14	12	1/2	30	1-1/4	24	12500	6/24	U3150	0508	2172	
150	6	22,2	7/8	12	1/2	30	1-1/4	24	12500	6/24	U3150	0509	0510 2171
150	6	M14+5/8"	12	1/2	30	1-1/4	24	12500	6/24	U3150	2585		
150	6	22,2	7/8	12	1/2	30	1-1/4	30	12500	6/24	UH3150	0551	
150	6	22,2	7/8	12	1/2	30	1-1/4	24	12500	6/24	UR3150	0564*	0565
180	7-1/8	22,2	7/8	12	1/2	34	1-3/8	32	9000	6/12	U5180	0519	0904
200	8	22,2	7/8	12	1/2	45	1-3/4	32	9000	5	U5200	0522	

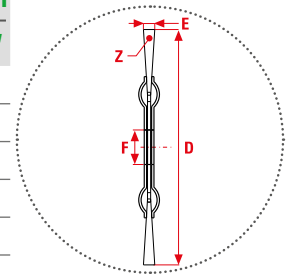

\*Acciaio Temprato / hardened steel

Passando dalla serie U, alla UH, alla UZ aumenta la densità del filamento e diminuisce lo spessore dei mazzetti. La serie UR registra performance fino a 3.5 volte superiori rispetto alla serie U.

Moving from U range to UH range to UZ, the wire density increases whereas the twisted knots thickness decreases. The UR range records performances up to 3.5 times higher than the U range.

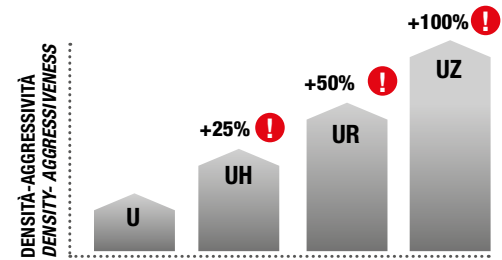
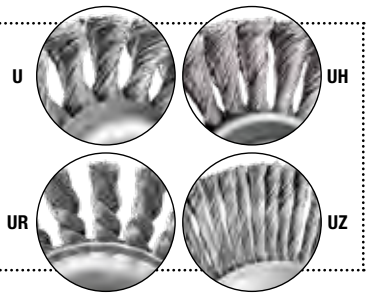

### APPLICAZIONI / APPLICATIONS

Preparazione e finitura di saldature continue, sbavature, decapaggio meccanico.

Preparation and finishing of continuous welding, deburring, mechanical pickling.

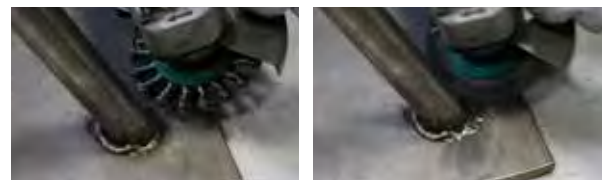

## > Spazzole circolari a mazzetti ritorti / Twist knot wheel brushes

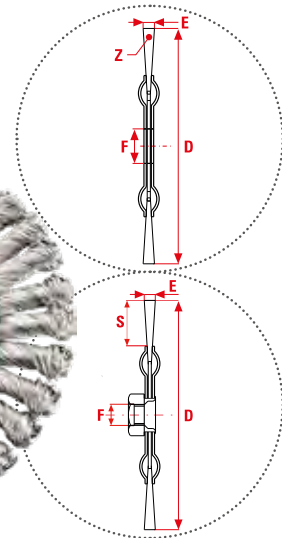
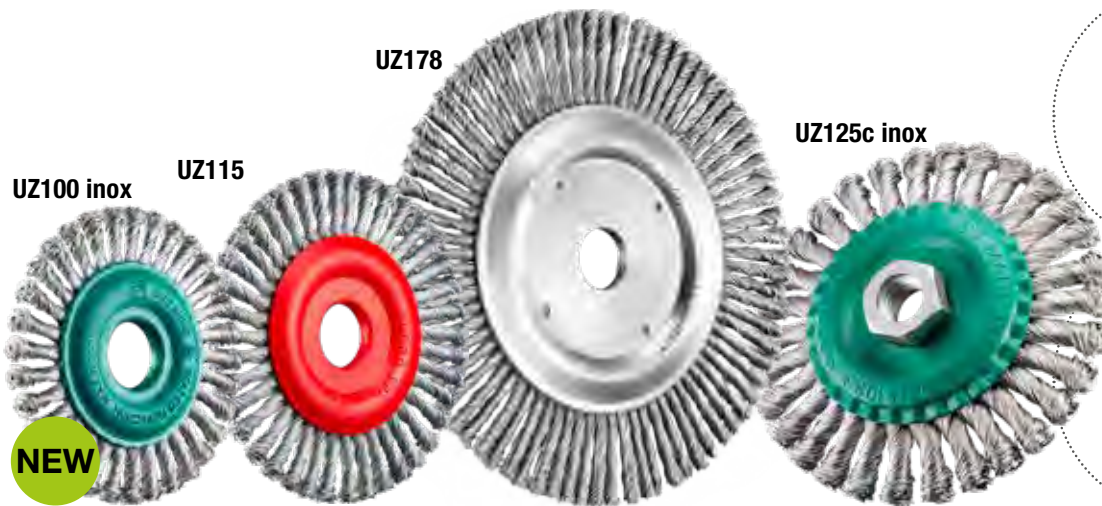

**UZ** Spazzole adatte a lavori "di taglio" su superfici irregolari, con spigoli, profili e fessure. Sottili e con altissima densità di filamento.  
**UZV** Mazzetto ritorto d'acciaio annegato in una soluzione poliuretanic. Caratterizzata da consumo regolare dei filamenti, spessore costante della superficie abrasiva, mancanza di rottura dei filamenti e maggiore sicurezza dell'operatore.

**UZ** These brushes are suitable for sideways jobs on irregular surfaces, with edges, profiles and cracks. They are thin and have high wire density.  
**UZV** Twist knots embedded in a polyurethane solution. It is characterized by regular trim wearout, constant width of the abrasive surface, lack of wires' breakage and greater safety during operations.

### Circolari UZ / Wheel brushes UZ

D		F		E		S		Z	MAX RPM	ART	0,50mm 0,50mm		* leggermente coniche / slightly conical	
mm	inch	mm	inch	mm	inch	mm	inch				0,020"	0,020"		
100	4	22,2	7/8	6	1/4	20	3/4	32	20000	12/96	<b>UZ100</b>	<b>0560</b>	<b>0562</b>	
100	4	M14+5/8"		6	1/4	20	3/4	32	20000	12/96	<b>UZ100</b>	<b>0561</b>	<b>0563</b>	
115	4-1/2	M14		6	1/4	23	7/8	40	20000	12/48	<b>UZ115</b>	<b>0541</b>	<b>0543</b>	
115	4-1/2	22.2	7/8	6	1/4	23	7/8	40	20000	12/48	<b>UZ115</b>	<b>0542</b>	<b>0544</b>	
115	4-1/2	M14+5/8"		6	1/4	23	7/8	40	20000	12/48	<b>UZ115</b>	<b>2587</b>	<b>0536</b>	
115	4-1/2	22.2	7/8	10	3/8	21	7/8	30	20000	12/48	<b>UZ115c*</b>	<b>0553</b>		
125	5	M14		6	1/4	26	1-1/32	40	20000	10/40	<b>UZ125</b>	<b>0545</b>	<b>0547</b>	
125	5	22.2	7/8	6	1/4	26	1-1/32	40	20000	10/40	<b>UZ125</b>	<b>0546</b>	<b>0548</b>	
125	5	M14+5/8"		6	1/4	26	1-1/32	40	20000	10/40	<b>UZ125</b>	<b>0535</b>	<b>0534</b>	
125	5	M14		10	3/8	24	1	30	15000	10/40	<b>UZ125c*</b>	<b>0549</b>	<b>2108</b>	
125	5	22.2	7/8	10	3/8	24	1	30	15000	10/40	<b>UZ125c*</b>	<b>0550</b>	<b>2109</b>	
125	5	M14+5/8"		10	3/8	24	1	30	15000	10/40	<b>UZ125c*</b>	<b>2614</b>		
150	6	M14		6	1/4	30	1-1/4	48	12500	6/24	<b>UZ150</b>	<b>0515</b>		
150	6	22.2	7/8	6	1/4	30	1-1/4	48	12500	6/24	<b>UZ150</b>	<b>0516</b>		
178	7	M14		6	1/4	33	1-3/4	76	12500	6/20	<b>UZ178</b>	<b>0518</b>	<b>0903</b>	
178	7	M14+5/8"		6	1/4	33	1-3/4	76	12500	6/24	<b>UZ178</b>	<b>0521</b>	<b>0906</b>	
178	7	22.2	7/8	6	1/4	33	1-3/4	76	12500	10/20	<b>UZ178</b>	<b>0517</b>	<b>0902</b>	
178	7	22.2	7/8	6	1/4	33	1-3/4	48	12500	10/20	<b>UZ178L</b>	<b>0520</b>		
178	7	22.2	7/8	6	1/4	33	1-3/4	56	12500	10/20	<b>UZ178</b>	<b>0504</b>		



### Circolari UZ vulcanizzate / Encapsulated UZ wheel brushes

D		F		E		S		Z	MAX RPM	ART	0,50mm	
mm	inch	mm	inch	mm	inch	mm	inch				0,020"	
115	4-1/2	22,2	7/8	6	1/4	27,5	1-1/8	40	15000	2/64	<b>UZV115</b>	<b>0174</b>
125	5	22,2	7/8	6	1/4	27,5	1-1/8	40	15000	2/64	<b>UZV125</b>	<b>0164</b>
178	7	22,2	7/8	6	1/4	36	1-3/8	76	9000	10/40	<b>UZV178</b>	<b>0167</b>



### APPLICAZIONI / APPLICATIONS

Rimozione di ruggine, incrostazioni, eccessi di plastica e gomma. Per tutta la produzione specifica nel settore Pipeline. Indicate per preparare e pulire saldature "stringer bead".  
 Removal of rust, slags, exceeding plastic and rubber. Suitable for the whole specific Pipeline production range. Ideal for "stringer bead" weld preparation and cleaning.

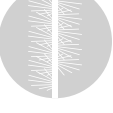

## > Spazzole circolari in filo ondulato / Crimped wire wheel brushes



Spazzole circolari in filo ondulato adatte a lavori "di taglio" su superfici irregolari, con spigoli, profili e fessure. In acciaio ondulato ad altissima resistenza, queste spazzole sono compatte, aggressive e sicure. La serie 3000 è adatta per mini-smerigliatrice.

**CV** Filamento d'acciaio ondulato annegato in una soluzione poliuretanic. Caratterizzata da consumo regolare dei filamenti, spessore costante della superficie abrasiva, mancanza di rottura dei filamenti e maggiore sicurezza dell'operatore.

*Crimped wire wheel brushes suitable for sideways jobs on irregular surfaces, with edges, profiles and cracks. The crimped wire is extremely resistant and these brushes are compact, aggressive and safe.*

*The range 3000 is suitable for mini-grinder*

**CV** Crimped wire embedded in a polyurethane solution. It is characterized by regular trim wearout, constant width of the abrasive surface, lack of wires' breakage and greater safety during operations.

### Circolari serie 3000 / Wheel brushes range 3000

D		F		E		S		MAX RPM		ART	0,35mm	0,30mm
mm	inch	mm	inch	mm	inch	mm	inch				0,014"	0,012"
115	4-1/2	M14+5/8"	*	12	1/2	18	3/4	15000	1/32	<b>3111</b>	<b>2466</b>	<b>2468</b>
125	5	M14+5/8"	*	14	5/8	23	7/8	15000	1/32	<b>3121</b>	<b>2467</b>	<b>2469</b>

**IMPROVED PERFORMANCE**

### Circolari serie 6000 / Wheel brushes range 6000

D		F		E		S		MAX RPM		ART	0,35mm	0,30mm
mm	inch	mm	inch	mm	inch	mm	inch				0,014"	0,012"
150	6	M14		15	9/16	25	1	9000	6/24	<b>6151</b>	<b>2471</b>	<b>2481</b>
150	6	22.2	7/8	15	9/16	25	1	9000	6/24	<b>6151</b>	<b>2470</b>	<b>2480</b>
180	7-1/8	M14		18	3/4	40	1-5/8	9000	6/24	<b>6181</b>	<b>2476</b>	<b>2486</b>
180	7-1/8	22.2	7/8	18	3/4	40	1-5/8	9000	6/24	<b>6181</b>	<b>2475</b>	<b>2485</b>

CV125

CV178

### Circolari vulcanizzate / Encapsulated wheel brushes

D		F		E		S		MAX RPM		ART	0,38mm
mm	inch	mm	inch	mm	inch	mm	inch				0,015"
115	4-1/2	M14		5,5	1/4	27,5	1-1/8	15000	2/64	<b>CV115</b>	<b>0169</b>
125	5	M14		5,5	1/4	27,5	1-1/8	15000	2/64	<b>CV125</b>	<b>0165</b>
150	6	22,2	7/8	5,5	1/4	25	1	9000	2/32	<b>CV150</b>	<b>0177</b>
178	7	22,2	7/8	5,5	1/4	36	1-3/8	9000	10/40	<b>CV178</b>	<b>0166</b>

\* Disponibili anche con foro 22,2 / Also available with a 22,2 hole

### APPLICAZIONI / APPLICATIONS

Lavori su superfici angolari o sagomate ad alte velocità di rotazione. Rimozione di scorie, ruggine e residui da superfici di ogni materiale e forma.

*High speed operations on edges or profiles. Removal of waste, residues and rust from surfaces of any kind and material.*



# SMERIGLIATRICE / ANGLE GRINDER

**NEW** TECH

## > Spazzole con attacco rapido / Burshes with rapid changing system **XLOCK**

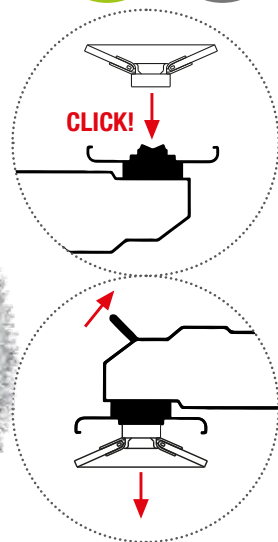

PATENT PENDING

X-LOCK è l'innovativo sistema per la sostituzione degli accessori brevettato da Bosch. Consente di agganciare e sganciare le spazzole dalle smerigliatrici angolari compatibili fino a 5 volte più velocemente ed in totale sicurezza.

X-LOCK is a new 2-piece changing system to switch angle grinder accessories with just one click. Allows to lock and unlock the brushes, from the compatible angle grinders, up to 5 times faster than the classical system in total safe conditions. A world's first by Bosch Professional.

### Tazze serie TU e TZ XLK / Cup brushes series TU and TZ XLK

D		F	S		Z	MAX RPM	Box	ART	0,50mm	0,50mm
mm	inch		mm	inch					0,020"	0,020"
70	2-3/4	<b>XLOCK</b>	17	5/8	17	12500	1/18	TU71 XLK	6014	6015
75	3	<b>XLOCK</b>	20	3/4	18	12500	1/18	TZ70 XLK	6000	6001

### Tazze serie T XLK / Cup brushes series T XLK

D		F	S		MAX RPM	Box	ART	0,35mm	0,30mm
mm	inch		mm	inch				0,014"	0,012"
80	3-1/8	<b>XLOCK</b>	25	1	12500	1/18	T80 XLK	6002	6003

### Coniche serie CZ e CO XLK / Bevel brushes series CZ and CO XLK

D		F	S		Z	MAX RPM	Box	ART	0,35mm	0,50mm	0,35mm	0,50mm
mm	inch		mm	inch					0,014"	0,020"	0,014"	0,020"
95	3-3/4	<b>XLOCK</b>	20	3/4	18	12500	1/36	CZ95 XLK		6004		6005
90	3-1/2	<b>XLOCK</b>	20	3/4		12500	1/36	CO90 XLK	6016		6017	

### Circolari serie U XLK / Wheel brushes series U XLK

D		F	E		S	Z	MAX RPM	Box	ART	0,50mm	0,50mm	
mm	inch		mm	inch						mm	inch	0,020"
115	4-2/3	<b>XLOCK</b>	10	3/8	23	7/8	20	20000	1/32	U115 XLK	6008	6009
125	5	<b>XLOCK</b>	10	3/8	28	1-1/8	20	20000	1/32	U125 XLK	6010	6011

### Circolari serie 3000 XLK / Wheel brushes series 3000 XLK

D		F	E		S	MAX RPM	Box	ART	0,35mm	0,50mm	
mm	inch		mm	inch					mm	inch	0,014"
125	5	<b>XLOCK</b>	14	5/8	23	7/8	15000	1/32	3121 XLK	6012	6013

**XLOCK**  
Tecnology by **BOSCH**

**VELOCITÀ DI SETUP**  
**SETUP SPEED**  
**X5**



**GUARDA IL VIDEO**  
**WATCH THE VIDEO**  
  
sitbrush.tv/xlk



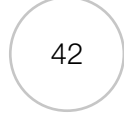
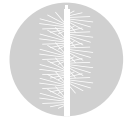

## SMERIGLIATRICE / ANGLE GRINDER

### > Box misto / Display box

Box Misto Mini smerigliatrice TECH  
Display box for grinder TECH



Box Misto Mini smerigliatrice  
Display box for grinder



Pratico Display Box contenente 4 pezzi per tipo delle spazzole più utilizzate.

Handy Display Box containing 4 pieces per type of the most used brushes.

### Box mini smerigliatrice TECH / Display box for mini-grinder TECH

TECH

Contenuto / Contents		Ref
----------------------	--	-----

4 TU71 M14 (Ref 240) + 4 T80 M14 (Ref 127) + 4 CZ95 M14 (Ref 309) + 4 CO90 M14 (Ref 173)	1/4	0360
--	-----	------

### Box mini smerigliatrice / Display box for mini-grinder

Contenuto / Contents		Ref
----------------------	--	-----

4 TZ70 M14 (Ref 325) + 4 TE80 M14 (Ref 105) + 4 CZ95 M14 (Ref 309) + 4 CO90 E M14 (Ref 106)	1/4	0361
---	-----	------

### Box X-LOCK / Display box for X-LOCK

Contenuto / Contents	Ref
----------------------	-----

1 TZ70 XLK (Ref 6000) + 1 T80 XLK (Ref 6002) + 1 CZ95 XLK (Ref 6004) + 1 CO90 XLK (Ref 6016)	1/4 6020
--	----------

**XLOCK**

Technology by BOSCH



- Le spazzole per smerigliatrice in confezionamento multiplo hanno etichetta barcode.  
Each brush for grinder sold in multiple pack has its own barcode.

### APPLICAZIONI / APPLICATIONS

Eliminare scorie, ruggine, vernici e forti incrostazioni da superfici di ogni materiale.  
Removal of rust, paint and thick encrustations from any kind of surface and material.

# TRAPANO DRILL

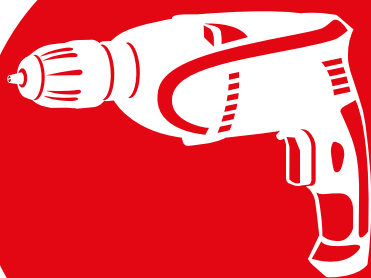

## SPAZZOLE CIRCOLARI / WHEEL BRUSHES

p. 44



> Spazzole circolari  
*Stem mount wheel brushes*

p. 46



> Ruote lamellari e ruote di finitura  
*Flap wheels and finishing wheels*

p. 53

## SPAZZOLE A TAZZA E CONICHE / CUP AND BEVEL BRUSHES

p. 54



> Spazzole coniche  
*Stem mount bevel brushes*

p. 55



> Spazzole a tazza  
*Stem mount cup brushes*

p. 56

## PENNELLI / END BRUSHES

p. 58



> Pennelli  
*End brushes*

p. 59



> Mini spazzole  
*Mini brushes*

p. 65



> Box misti  
*Mixed Display boxes*

p. 66





# > Spazzole circolari / Wheel brushes



[www.sitbrush.tv/d1](http://www.sitbrush.tv/d1)

## DISEGNI TECNICI / TECHNICAL DRAWINGS

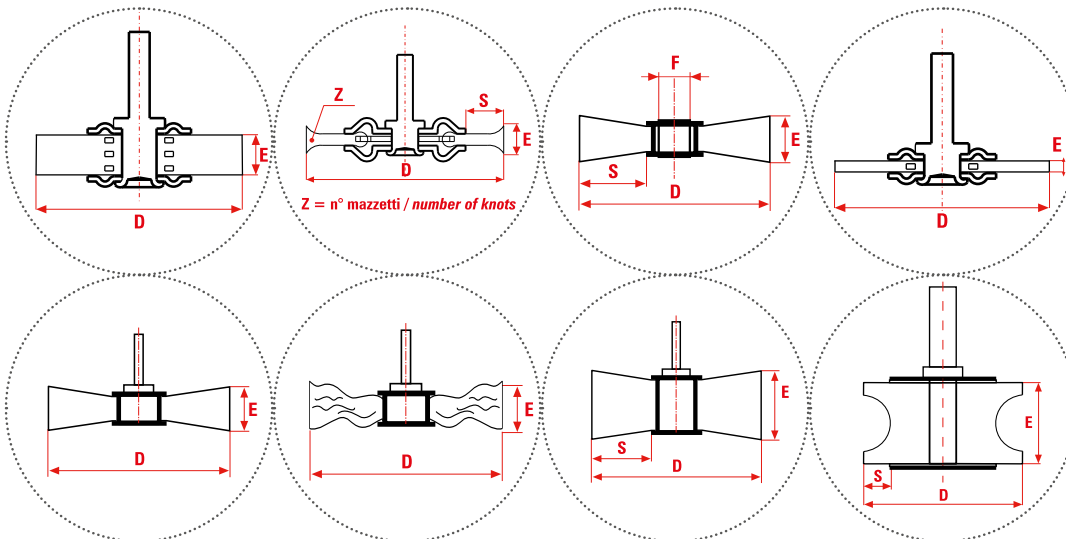

### LEGENDA PACK

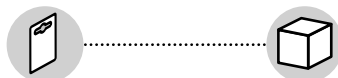

#### Blister

e.g. B/6/48

Blister singolo in scatole da 6 pezzi con eventuale imballo secondario da 48 pezzi / Single blister pack in boxes containing 6 pcs with 48-pcs secondary packaging (if any)

#### Multipack

e.g. 12/96

Confezione multipla da 12 pezzi con eventuale imballo secondario da 96 pezzi / Multiple pack containing 12 pcs with 96-pcs secondary packaging (if any)

## NOTE / NOTES

**E = spessore nominale.** Lo spessore reale può essere leggermente superiore.  
**E = nominal face width.** The actual face width may be slightly higher.

Se non indicato diversamente, le spazzole circolari per trapano SIT hanno gambo 6x25 mm - 1/4"x1".  
Unless otherwise noted, SIT wheel brushes for drills have shank 6x25 mm - 1/4"x1".

**Gli articoli con Ref ROSSA sono i più venduti / scelte consigliate**  
**Items marked in RED are the best sellers / recommended choice**

### LEGENDA

#### FILO / FILAMENT



**Acciaio / Steel**

**Acciaio ottonato / Brass Plated Steel**

**Inox / Stainless Steel**

**Ottone / Brass**

**Cordicella d'acciaio Liz / LIZ Steel Cord**

**Nylon abrasivo / Abrasive Nylon**

Nylon abrasivo arancione (grana 120), più aggressivo / Orange abrasive Nylon (120 grit), more aggressive.  
Nylon abrasivo blu (grana 180), meno aggressivo / Blue abrasive Nylon (180 grit), less aggressive.





## > Spazzole circolari / Wheel brushes

### CLEPSYDRA ACCIAIO / STEEL



### CLEPSYDRA INOX / S. STEEL

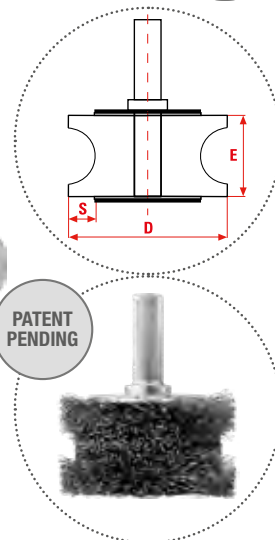

Circularina sagomata secondo brevetto SIT con gambo da 10x28mm - 3/8"x1-1/8" zigrinato per un più saldo serraggio. La sagomatura funge da guida, per facilitare l'applicazione.

Small circular brush shaped as per SIT patent with shank 10x28mm - 3/8"x1-1/8", knurled for firmer tightening. The shape serves as a guide for easier use.

### CLEPSYDRA

D		S		E		MAX RPM		ART	0,30mm	0,30mm	0,20mm	1mm - 0,40"
mm	inch	mm	inch	mm	inch				0,012"	0,020"	0,008"	120 gr
60-50	2-3/8	10	3/8	30	1-1/4	12500	6/48	CLEPSYDRA	0768			
60-50	2-3/8	10	3/8	29	1-1/4	12500	B/6/48	CLEPSYDRA	0880	0891	0883	0893

### Nylon abrasivo / Abrasive Nylon

Attenzione alle velocità di rotazione consigliate per ogni applicazione: vedi tabella 2 pag. 21  
Pay attention to the recommended speed for each application: see table 2 page 21



### CLEPSYDRA OTTONE / BRASS



### CLEPSYDRA NYLON ABRASIVO / ABRASIVE NYLON



**APPLICAZIONI / APPLICATIONS**  
Lavorazioni di sverniciatura e rimozione ruggine più rapide ed efficaci su tubi, profili curvi e spigoli.  
Faster, more effective paint stripping and rust removal operations on pipes, curved profiles and edges.

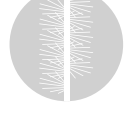

## > Spazzole circolari / Wheel brushes

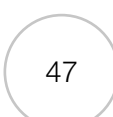

GG74 inox



GG62



GG52



GG44 inox



GG43

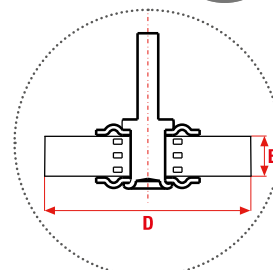

Spazzole circolari con gambo, in acciaio ondulato ad alta resistenza e ad altissima densità di filo. Assicurano lunga durata e grande resa nelle varie lavorazioni industriali.

**GG53:** in acciaio ottonato ad alta resistenza. Ideale per la pulizia delle seghe a nastro.

Shank mounted wheel brushes, made of highly resistant crimped wire with high wire density. They ensure long service life and great performance in many industrial applications.

**GG53:** made of highly resistant brass plated steel wire. Ideal for band saws cleaning.

### Circolari GG / Wheel brushes GG

D		E		MAX RPM		ART	0,15mm	0,30mm	0,30mm
mm	inch	mm	inch				0,006"	0,012"	0,012"
18	3/4	3	1/8	18000	12/96	<b>GG21</b>	<b>3145*</b>		
25	1	5	3/16	18000	12/96	<b>GG25</b>	<b>3146*</b>		
30	1-1/8	9	3/8	18000	12/96	<b>GG32</b>	<b>0848</b>		
40	1-5/8	9	3/8	18000	12/96	<b>GG42</b>		<b>0850</b>	<b>2502</b>
40	1-5/8	12	1/2	18000	12/96	<b>GG43</b>		<b>0851</b>	<b>0966</b>
40	1-5/8	15	9/16	18000	12/96	<b>GG44</b>		<b>0853</b>	<b>0967</b>
50	2	12	1/2	15000	36/144	<b>GG53 M6</b>		<b>3151</b>	
50	2	9	3/8	15000	12/96	<b>GG52</b>	<b>0856</b>	<b>0855</b>	<b>2505</b>
50	2	12	1/2	15000	12/96	<b>GG53</b>		<b>0857</b>	<b>0968</b>
50	2	15	9/16	15000	12/96	<b>GG54</b>		<b>0859</b>	<b>0969</b>
50	2	18	3/4	15000	36/144	<b>GG55</b>		<b>0858</b>	
50	2	21	7/8	15000	36/144	<b>GG56</b>		<b>0860</b>	
60	2-3/8	9	3/8	15000	12/96	<b>GG62</b>	<b>0862</b>	<b>0861</b>	<b>2508</b>
60	2-3/8	12	1/2	15000	12/96	<b>GG63</b>		<b>0863</b>	<b>0971</b>
60	2-3/8	15	9/16	15000	12/96	<b>GG64</b>		<b>0865</b>	<b>0972</b>
70	2-3/4	9	3/8	15000	12/96	<b>GG72</b>	<b>0868</b>	<b>0867</b>	<b>2510</b>
70	2-3/4	12	1/2	15000	12/96	<b>GG73</b>		<b>0869</b>	<b>0973</b>
70	2-3/4	12	1/2	15000	B/6/48	<b>B GG73</b>		<b>0217</b>	
70	2-3/4	12	1/2	15000	12/96	<b>GG73 super inox</b>			<b>0999</b>
70	2-3/4	15	9/16	15000	12/96	<b>GG74</b>		<b>0871</b>	<b>0974</b>

GG53 M6



**GG73** super inox con flange Ø 30mm - 1-1/4" in acciaio inox / *super inox with stainless steel flanges Ø 30mm - 1-1/4"*.

\* Ref 3145 Ø 0,10mm - 0,004"; Ref 3146 Ø 0,20mm - 0,008".

### APPLICAZIONI / APPLICATIONS

Rimozione di scorie, ruggine e residui di lavorazione da superfici di ogni materiale e forma.

*Dust, rust and waste removal from any kind of surface.*





## > Spazzole circolari / Wheel brushes

GG102

GG102 inox

GG102 Liz

GG83 ottone / brass

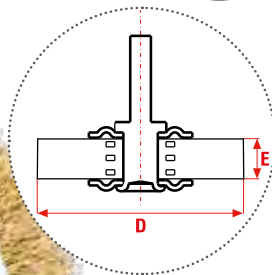

Spazzole circolari con gambo, in acciaio ondulato ad alta resistenza e ad altissima densità di filo. Assicurano lunga durata e grande resa nelle varie lavorazioni industriali. Adatte anche al montaggio su macchinari fissi e centri di lavoro.

Shank mounted wheel brushes made of highly resistant crimped wire with high wire density. They ensure long service life and great performance in various industrial processes. Suitable to be mounted onto fix machineries and working stations.

### Circolari GG / Wheel brushes GG

D		E		MAX RPM		ART	0,20mm	0,30mm	0,30mm	0,30mm	0,25mm
mm	inch	mm	inch				0,008"	0,012"	0,012"	0,012"	0,010"
80	3-1/8	9	3/8	12000	12/96	<b>GG82</b>	<b>0873</b>	<b>2513</b>			
80	3-1/8	9	3/8	12000	12/96	<b>GG82</b>		<b>0854*</b>			
80	3-1/8	12	1/2	12000	12/96	<b>GG83</b>	<b>0874</b>	<b>0976</b>	<b>0876</b>		
80	3-1/8	15	9/16	12000	12/96	<b>GG84</b>	<b>0877</b>	<b>0977</b>			
100	4	9	3/8	10000	12/96	<b>GG102</b>	<b>0875</b>	<b>0879</b>	<b>0979</b>	<b>0881</b>	<b>9635</b>
100	4	16	5/8	10000	10/40	<b>GG103</b>	<b>0882</b>	<b>0866</b>			
100	4	16	5/8	10000	B/6/48	<b>B GG103</b>	<b>0219</b>				

REF 0882, 0219 Acciaio Ottonato / Brass Plated Steel.

Tutte le circolarine della serie GG possono essere fornite con FORO 8mm - 5/16" allo stesso prezzo, ordine minimo 120 pz. All GG wheel brushes can be supplied with ARBOR HOLE 8mm - 5/16" at the same price, minimum order quantity 120 pcs.

\* Inox 0,20mm / S. Steel 0,008



### Circolari GG-HEX con attacco rapido / Rapid load wheel brushes GG-HEX

D		E		MAX RPM		ART	0,30mm	0,30mm
mm	inch	mm	inch				0,012"	0,012"
50	2	9	3/8	6500	12/96	<b>GG52 HEX</b>	<b>0864</b>	<b>2506</b>

La linea HEX monta un gambo esagonale da 6,35mm - 1/4" che si adatta a qualsiasi tipo di mandrino o di avvitatore e permette l'attacco rapido. / The HEX line features a 6.35mm - 1/4" hexagonal shank that is suitable for any type of spindle or screwdriver and allows for quick coupling.

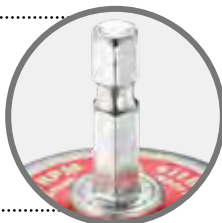

GG52 HEX

### APPLICAZIONI / APPLICATIONS

Rimozione di scorie, ruggine e residui di lavorazione da superfici di ogni materiale e forma. Dust, rust and waste removal from any kind of surface.





> Spazzole circolari / Wheel brushes

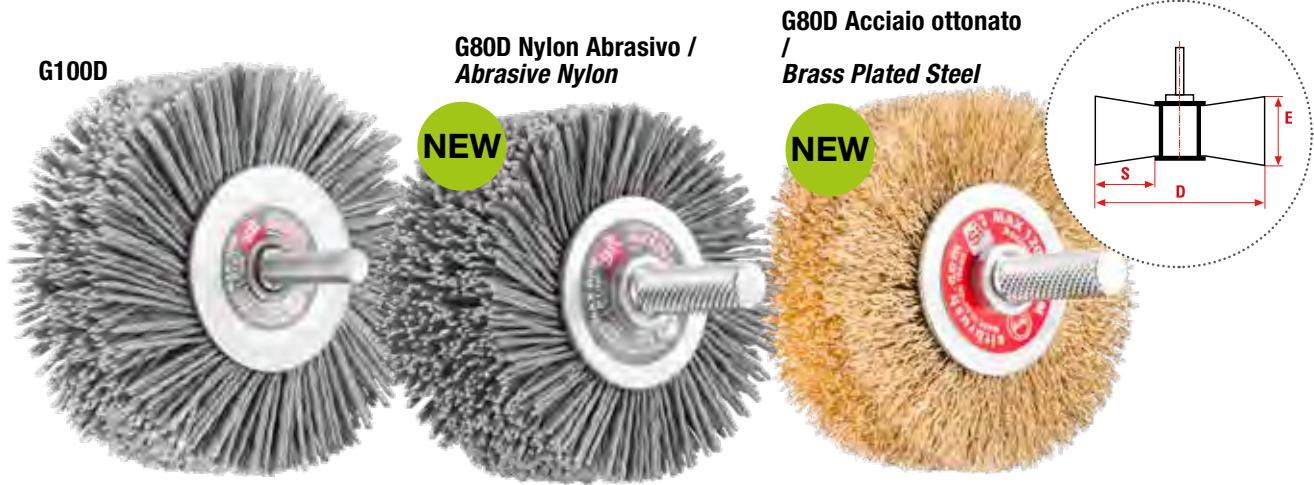

**G80D-G100D** Circolari per trattamento legno. Gambo 10x28mm - 3/8"x1-1/8".

**G80D-G100D** Wheel brushes for wood processing. Shank 10x28mm - 3/8"x1-1/8".

**G80D XL** Rulletti per il trattamento legno. Gambo 10x28mm - 3/8"x1-1/8".

**G80D XL** Rollers for wood treatment. Shank 10x28mm - 3/8"x1-1/8".

**Circolari G80D, G80D XL e G100D / G80D, G80D XL and G100D wheel brushes**

D		S		E		MAX RPM	2	ART	0,30mm	0,20mm	1,2mm-0,05"	1mm-0,04"	1mm-0,04"
mm	inch	mm	inch	mm	inch				0,012"	0,008"	80 gr	120 gr	180 gr
80	3-1/8	20	3/4	30	1-1/4	10000	2/24	<b>G80D</b>	<b>0884*</b>				
80	3-1/8	20	3/4	30	1-1/4	6500	2/24	<b>G80D</b>				<b>0994</b>	
80	3-1/8	20	3/4	60	2-3/8	6500	1/24	<b>G80D XL</b>	<b>0894</b>	<b>0878</b>		<b>0870</b>	
100	4	25	1	40	1-9/16	6000	2/12	<b>G100D</b>			<b>3155</b>		

\*Acciaio ottonato / Brass Plated Steel

G100D gambo 8x28mm - 6/16 8"x1-1/8" / G100D shank 8x28mm - 5/16"x1-1/8".

Nylon abrasivo / Abrasive Nylon

Attenzione alle velocità di rotazione consigliate per ogni applicazione: vedi tabella 2 pag. 21  
Pay attention to the recommended speed for each application: see table 2 page 21



**G80D XL Acciaio / Steel**

**G80D XL Nylon Abrasivo / Abrasive Nylon**

**G80D XL Ottone / brass**



**APPLICAZIONI / APPLICATIONS**

Pulizia, sverniciatura, rimozione cortecchia e rusticatura del legno (tronchi, assi, semilavorati).  
Cleaning, paint removal, bark removal, wood aging (trunks, planks, semi-finished products).

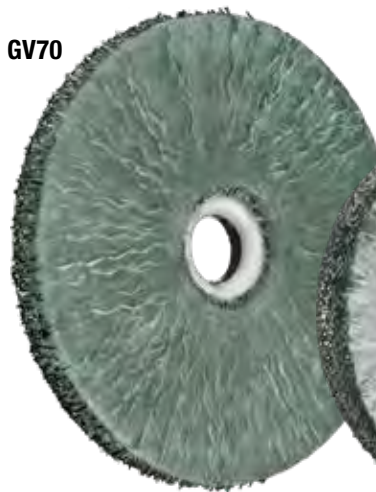
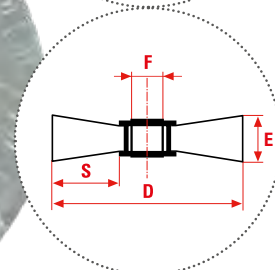
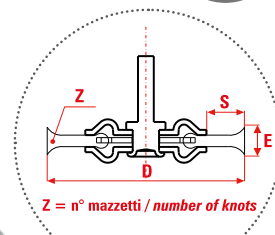

**> Spazzole circolari / Wheel brushes**
**GZ71**

**GV70**

**GV50**

**GZ** Spazzole circolari con gambo, in acciaio ad alta resistenza. Aggressive grazie ai mazzetti ritorti.

**GZ** Shank mounted wheel brushes, made of highly resistant steel wire. The twist knots make them aggressive.

**GV** Spazzole circolari in filo d'acciaio ottonato annegato in una soluzione polituretanica e con gambo intercambiabile. Assicurano lunga durata e massima sicurezza d'impiego.

**GV** Wheel brushes with interchangeable shank, made of brass plated crimped wire encapsulated in plastic material. They are long lasting and ensure maximum safety.

**Circolari a mazzetti ritorti GZ / Twist knot wheel brushes GZ**

D		E		S		Z	MAX RPM	Box	ART	0,50mm	
mm	inch	mm	inch	mm	inch					0,020"	
70	2-3/4	10	3/8	15	9/16	15	20000	12/96	<b>GZ71</b>	<b>0300</b>	
70	2-3/4	10	3/8	15	9/16	15	6500	12/96	<b>GZ71 HEX</b>	<b>0318</b>	
70	2-3/4	10	3/8	15	9/16	15	20000	B/6/48	<b>B GZ71</b>	<b>0301</b>	
70	2-3/4	10	3/8	15	9/16	30	20000	12/96	<b>GZ72</b>	<b>0305</b>	
100	4	10	3/8	25	1	15	20000	12/96	<b>GZ100</b>	<b>0302</b>	

**NEW**
**GZ71 HEX**
**Circolari vulcanizzate GV / Encapsulated wheel brushes GV**

D		E		S		F	MAX RPM	Box	ART	0,50mm	
mm	inch	mm	inch	mm	inch					mm	inch
50	2	8	5/16	12	1/2	10	3/8	15000	12/96	<b>GV50</b>	<b>0790</b>
60	2-3/8	8	5/16	17	5/8	10	3/8	15000	12/96	<b>GV60</b>	<b>0791</b>
70	2-3/4	8	5/16	22	7/8	10	3/8	15000	12/96	<b>GV70</b>	<b>0792</b>

Gambo 6x18mm - 1/4"x11/16" con attacco M10 + 3 coppie di flange  
 Ø 25,30,38mm - 1", 1-1/8", 1-1/2" / Shank 6x18mm - 1/4"x11/16" with  
 M10 thread + 3 pairs of flanges Ø 25,30,38mm - 1", 1-1/8", 1-1/2"

12/96

**GV10**
**0789**

La linea HEX monta un gambo esagonale da 6,35mm - 1/4" che si adatta a qualsiasi tipo di mandrino o di avvitatore e permette l'attacco rapido. / The HEX line features a 6.35mm - 1/4" hexagonal shank that is suitable for any type of spindle or screwdriver and allows for quick coupling.

**APPLICAZIONI / APPLICATIONS**

Rimozione di scorie, ruggine e residui da ogni tipo di superficie. Le spazzole circolari GV assicurano abrasione uniforme.

Waste, rust and residues removal from any kind of surface. GV wheel brushes ensure regular abrasion.

**GV50**

## > Spazzole circolari / Wheel brushes



Spazzole circolari con gambo 6x21mm - 1/4"x7/8" in filo d'acciaio ottonato e inox ondulato.

Wheel brushes made of brass plated and inox crimped steel wire. Shank 6x21mm - 1/4"x7/8".

### Circolarine G / Wheel brushes G

D		E		MAX RPM		ART	0,30mm	0,30mm
mm	inch	mm	inch				0,012"	0,012"
30	1-1/8	4	3/16	6000	48/384	<b>G30</b>	<b>0885</b>	
30	1-1/8	9	3/8	6000	12/96	<b>G30</b>		<b>2504</b>
30	1-1/8	4	3/16	6000	B/12/96	<b>B G30</b>	<b>0220</b>	
40	1-5/8	5	3/16	4500	48/384	<b>G40</b>	<b>0886</b>	
40	1-5/8	9	3/8	4500	12/96	<b>G40</b>		<b>2512</b>
50	2	5	3/16	4500	36/288	<b>G50</b>	<b>0887</b>	
50	2	9	3/8	4500	12/96	<b>G50</b>		<b>2514</b>
50	2	5	3/16	4500	B/12/96	<b>B G50</b>	<b>0218</b>	
50	2	5	3/16	4500	B/6/48	<b>B G50</b>		<b>0965</b>
60	2-3/8	5	3/16	4500	24/192	<b>G60</b>	<b>0888</b>	
60	2-3/8	9	3/8	4500	12/96	<b>G60</b>		<b>2516</b>
70	2-3/4	9	3/8	4500	12/96	<b>G70</b>		<b>2518</b>
75	3	7	5/16	4500	24/192	<b>G75</b>	<b>0889</b>	
75	3	7	5/16	4500	B/12/96	<b>B G75</b>	<b>0216</b>	
75	3	7	5/16	4500	B/6/48	<b>B G75</b>		<b>0970</b>
80	3-1/8	9	3/8	4500	12/96	<b>G80</b>		<b>2520</b>
100	4	9	3/8	4500	12/96	<b>G100</b>	<b>0890</b>	<b>0978</b>
100	4	9	3/8	4500	B/12/96	<b>B G100</b>	<b>0205</b>	
100	4	9	3/8	4500	B/6/48	<b>B G100</b>		<b>0975</b>

#### • Differenza tra circolarine GG e circolarine G

Le GG sono ingegnerizzate per lavori gravosi e con maggiori velocità di rotazione. Ciò permette di ottenere il risultato desiderato in minor tempo e maggior aggressività. Montabili anche su utensili ad aria.

#### **Difference between GG and G wheel brushes:**

GG wheel brushes are engineered for heavy duty and high speed operations. They allow to reach the desired result faster and with increased aggressiveness. They can be mounted on air tools as well.

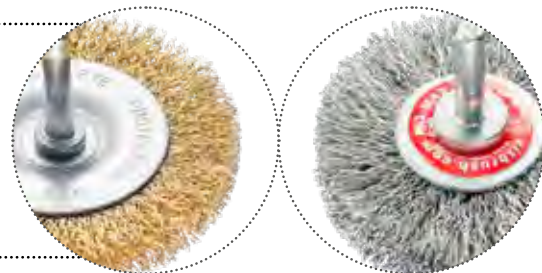

### APPLICAZIONI / APPLICATIONS

Rimozione di scorie, ruggine e residui di lavorazione da superfici di ogni materiale e forma. La serie G è adatta all'hobbista. Ideale per lavori leggeri di manutenzione e pulizia.

Dust, rust and waste removal from any kind of surface. G range brushes are suitable for the hobbyist. Ideal for light maintenance and cleaning operations.





# TRAPANO / DRILL

## > Spazzole circolari / Wheel brushes

G100B



G75A

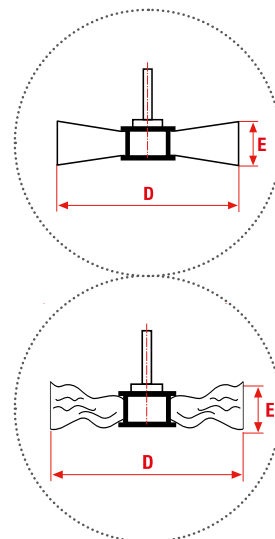

**G75-100 A-B** Spazzole in Nylon abrasivo con gambo 6x30mm - 1/4"x1-1/4": lunga durata, leggerezza, non graffiano e non arrugginiscono.

**G75-100 A-B** Abrasive Nylon wheel brushes with 6x30mm - 1/4"x1-1/4" shank. They are long lasting and light, they do not scratch or get rusted.

**SP** Spazzole circolari in panno con gambo 6x27mm - 1/4"x1-1/8". Da utilizzare con o senza la pasta abrasiva Dialux (vedi pag. 79).

**SP** Cloth wheel brushes with 6x27mm - 1/4"x1-1/8" shank. They can be used with or without Dialux polishing compounds (see page 79).

### Circolari in Nylon abrasivo / Abrasive Nylon wheel brushes

D		E		MAX RPM		ART	Abrasit A Abrasit B	
mm	inch	mm	inch				120 gr	180 gr
75	3	5	3/16	4500	24/192	<b>G75A - G75B</b>	<b>0609</b>	<b>0619</b>
75	3	5	3/16	4500	B/6/48	<b>B G75A - B G75B</b>	<b>0610</b>	<b>0620</b>
100	4	5	3/16	4500	14/112	<b>G100A - G100B</b>	<b>0611</b>	<b>0621</b>
100	4	5	3/16	4500	B/6/48	<b>B G100A - B G100B</b>	<b>0612</b>	<b>0622</b>

### Circolari in panno SP / Cloth brushes SP

D		E		MAX RPM	Densità Density		ART	Panno Cloth
mm	inch	mm	inch					
80	3-1/8	10	3/8	4000	90	12/96	<b>SP80</b>	<b>0401</b>
80	3-1/8	10	3/8	4000	90	B/6/48	<b>B SP80</b>	<b>0402</b>



SP80



### APPLICAZIONI / APPLICATIONS

**G75-100 A-B** Ideali su pietra, mattoni, tegole, cemento, legno e metalli.

**SP** Pulizia e lucidatura delle superfici ferrose e non ferrose.

**G75-100 A-B** They are ideal on stone, bricks, tiles, cement, wood and metals.

**SP** Cleaning and polishing of ferrous and non-ferrous surfaces.



## > Spazzole circolari e ruote lamellari / Wheel brushes and flap wheels

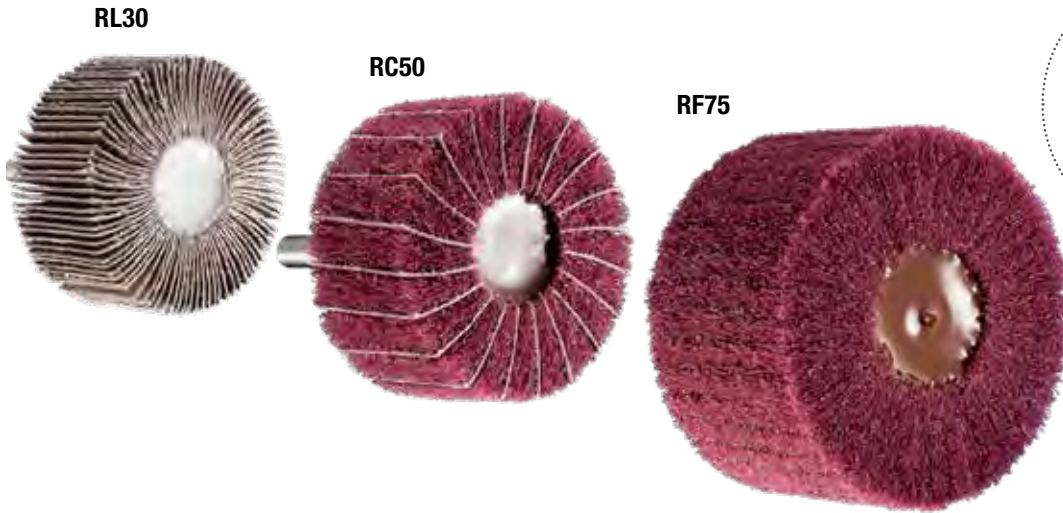

**RL** Lamelle di tela abrasiva. Gambo 6x40mm - 1/4"x1-5/8".  
**RC - RF** Spugna abrasiva con o senza lamelle. Gambo 6x35mm - 1/4"x1-3/8".

**RL** Abrasive flap cloth. Shank 6x40mm - 1/4"x1-5/8".  
**RC - RF** Non-woven abrasive wheels with or without abrasive flaps. 6x35mm - 1/4"x1-3/8" shank.

### Ruote lamellari / Abrasive flap wheels

D		E		MAX RPM	2	ART	A corundum 40 (A40)	A corundum 60 (A60)	A corundum 80 (A80)
mm	inch	mm	inch				(A40)	(A60)	(A80)
30	1-1/8	20	3/4	22800	10/80	<b>RL30</b>		<b>0470</b>	
40	1-5/8	30	1-1/8	17100	10/80	<b>RL40</b>	<b>0472</b>	<b>0473</b>	<b>0474</b>
50	2	30	1-1/8	13700	10/80	<b>RL50</b>	<b>0475</b>	<b>0476</b>	<b>0477</b>
50	2	20	3/4	13700	10/80	<b>RL50</b>			<b>0435</b>
50	2	30	1-1/8	13700	B/6/48	<b>B RL50</b>			<b>0410</b>
60	2-3/8	30	1-1/8	12750	10/80	<b>RL60</b>	<b>0478</b>	<b>0479</b>	<b>0480</b>
80	3-1/8	30	1-1/8	8600	10/80	<b>RL80</b>			<b>0436</b>
80	3-1/8	30	1-1/8	8600	B/6/48	<b>B RL80</b>			<b>0411</b>

### Ruote di finitura / Finishing wheels

D		E		MAX RPM	2	ART	Grana / Grit A 150gr	Flap grana fine / Fine grained flap
mm	inch	mm	inch				A 150gr	Fine grained flap
50	2	25	1	12000	25/100	<b>RC50 - RF50</b>	<b>0416</b>	<b>0417</b>
75	3	45	1-3/4	8000	10/80	<b>RC75 - RF75</b>	<b>0418</b>	<b>0419</b>
100	4	45	1-3/4	6500	10/80	<b>RC100 - RF100</b>	<b>0420</b>	<b>0421</b>

### APPLICAZIONI / APPLICATIONS

**RL, RC, RF** Finitura e satinatura di superfici ferrose e non ferrose.  
**RL, RC, RF** Finishing and satin finishing of ferrous and non-ferrous surfaces.



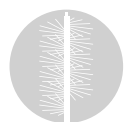

# > Spazzole a tazza e coniche / Cup and bevel brushes



www.sitbrush.tv/d2

## DISEGNI TECNICI / TECHNICAL DRAWINGS

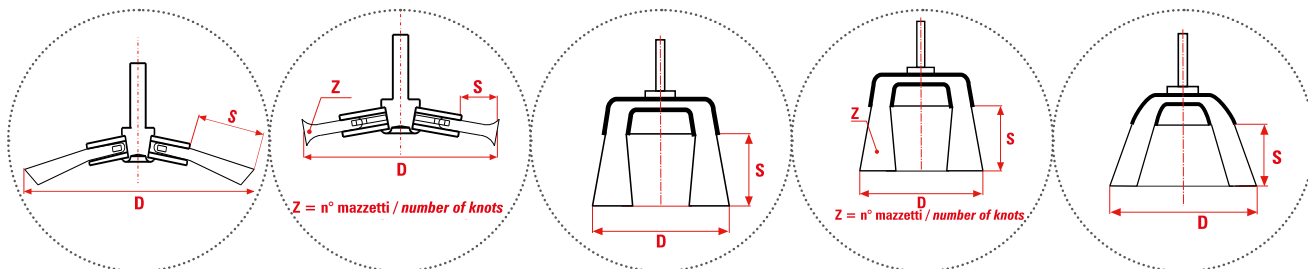

### LEGENDA PACK



**Blister**  
e.g. B/6/48  
Blister singolo in scatole da 6 pezzi con eventuale imballo secondario da 48 pezzi / Single blister pack in boxes containing 6 pcs with 48-pcs secondary packaging (if any)



**Multipack**  
e.g. 12/96  
Confezione multipla da 12 pezzi con eventuale imballo secondario da 96 pezzi / Multiple pack containing 12 pcs with 96-pcs secondary packaging (if any)

### NOTE / NOTES

**LIZ** La cordicella ottonata Liz è caratterizzata da altissima densità e altissima resistenza; ha maggiore durata, maggiore flessibilità e minore aggressività rispetto all'acciaio 0,35mm - 0,014". Il Liz è particolarmente indicato per la lavorazione di materiali semi-morbidi come la gomma.

**LIZ** Brass plated steel cord is characterized by high density and high resistance and it is longer lasting, more flexible and less aggressive than steel wire 0,35mm - 0,014". Liz is especially indicated for the processing of semi-soft materials such as rubber.

### LEGENDA FILO / FILAMENT



**Acciaio / Steel**  
**Acciaio ottonato / Brass Plated Steel**



**Inox / Stainless Steel**



**Ottone / Brass**



**Cordicella d'acciaio Liz / LIZ Steel Cord**



**Nylon abrasivo / Abrasive Nylon**  
Nylon abrasivo arancione (grana 120), più aggressivo / Orange abrasive Nylon (120 grit), more aggressive.  
Nylon abrasivo blu (grana 180), meno aggressivo / Blue abrasive Nylon (180 grit), less aggressive.



Se non indicato diversamente, le spazzole per trapano SIT hanno gambo 6x25mm - 1/4x1".  
Unless otherwise noted, SIT brushes for drills have 6x25mm - 1/4x1" shank.

**Gli articoli con Ref ROSSA sono i più venduti / scelte consigliate**  
**Items marked in RED are the best sellers / recommended choice**



> Spazzole coniche / Bevel brushes

C090 G



CZ95 G

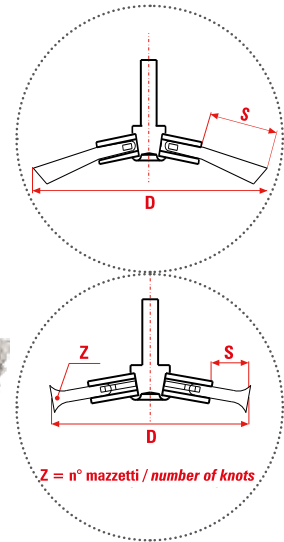

**CO, CZ** In acciaio ondulato ad alta resistenza o a mazzetti ritorti. La forma conica le rende adatte a lavori di taglio su superfici irregolari, con spigoli, profili e fessure.

**CO, CZ** Highly resistant crimped wire bevel brushes or twist knot bevel brushes. The conical shape makes them suitable for sideways jobs on irregular surfaces, with edges, profiles and cracks.

Spazzole coniche in filo ondulato / Crimped wire bevel brushes

D		S		MAX RPM		ART	0,35mm	0,30mm
mm	inch	mm	inch				0,014"	0,012"
95	3-3/4	20	3/4	6500	12/96	<b>C090 G</b>	<b>0170</b>	<b>0941</b>
95	3-3/4	20	3/4	6500	B/6/48	<b>B C090 G</b>	<b>0212</b>	<b>0940</b>

Spazzole coniche a mazzetti ritorti / Twist knot bevel brushes

D		S		Z	MAX RPM		ART	0,35mm
mm	inch	mm	inch					0,014"
95	3-3/4	20	3/4	15	6500	12/96	<b>CZ95 G</b>	<b>0307</b>
95	3-3/4	20	3/4	15	6500	B/6/48	<b>B CZ95 G</b>	<b>0306</b>



APPLICAZIONI / APPLICATIONS

- CO** Lavori di manutenzione, pulizia e sverniciatura di superfici irregolari.
- CZ** Lavori di manutenzione, rimozione scorie, ruggine e residui di lavorazione.
- CO** Maintenance, cleaning and paint removal from irregular surfaces.
- CZ** Maintenance, removal of waste, rust and processing residues.



## > Spazzole a tazza / Cup brushes



**T, TGZ** Spazzole a tazza con gambo per trapano. Ideali per superfici piane, in acciaio ondulato ad altissima resistenza o a mazzetti ritorti per maggiore aggressività.

**T, TGZ** Shank mounted cup brushes ideal for flat surfaces. They are made of highly resistant crimped or knotted steel wire to achieve higher aggressiveness.

### Spazzole a tazza in filo ondulato T / Crimped wire cup brushes T

D		S		MAX RPM	ART	0,30mm	0,30mm	0,30mm	0,25mm	0,55mm-0,022"
mm	inch	mm	inch			0,012"	0,012"	0,012"	0,010"	O.A. 320 gr
50	2	17	5/8	12000	12/96	<b>T50</b>	<b>0650</b>	<b>0984</b>	<b>0652</b>	<b>0653</b>
65	2-1/2	24	1	12000	12/96	<b>T60</b>	<b>0654</b>	<b>0987</b>		
70	2-3/4	20	3/4	12000	12/96	<b>T70</b>	<b>0655</b>	<b>0986</b>	<b>0657</b>	<b>9634</b>
70	2-3/4	20	3/4	12000	B/6/48	<b>B T70</b>	<b>0211</b>			

### Spazzole a tazza a mazzetti ritorti / Twist knot cup brushes

D		S		Z	MAX RPM	ART	0,35mm	
mm	inch	mm	inch				0,014"	
70	2-3/4	20	3/4	15	6500	12/96	<b>TGZ70</b>	<b>0303</b>
70	2-3/4	20	3/4	15	6500	B/6/48	<b>B TGZ70</b>	<b>0304</b>

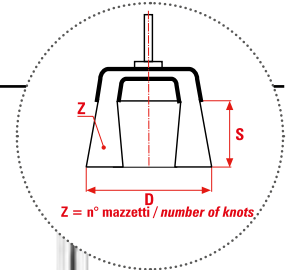

### Spazzole a tazza con attacco rapido / Rapid load cup brushes

D		S		Z	MAX RPM	ART	0,35mm	0,30mm
mm	inch	mm	inch				0,014"	0,012"
65	2-1/2	24	1		6500	12/96	<b>T60 HEX</b>	<b>0988</b>
70	2-3/4	20	3/4	15	6500	12/96	<b>TGZ70 HEX</b>	<b>0310</b>



La linea HEX monta un gambo esagonale da 6,35mm - 1/4" che si adatta a qualsiasi tipo di mandrino o di avvitatore e permette l'attacco rapido. / The HEX line features a 6.35mm - 1/4" hexagonal shank that is suitable for any type of spindle or screwdriver and allows for quick coupling.

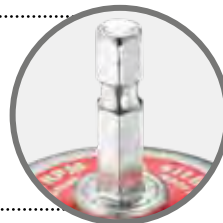

### APPLICAZIONI / APPLICATIONS

- T** Lavori pesanti di sverniciatura.
- TGZ** Rimozione aggressiva di scorie, ruggine e residui.
- T** Heavy-duty jobs of paint removal.
- TGZ** Heavy removal of slugs, rust and residues.



## > Spazzole a tazza / Cup brushes

TE50



TE75

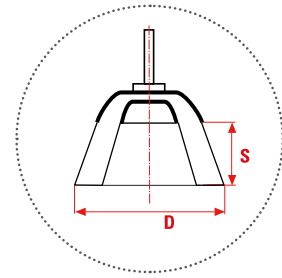

**TE** Spazzole a tazza in acciaio ottonato ondulato.

**T50-75 A-B** Tazze in Nylon abrasivo con gambo 6x30mm - 1/4"x1-1/4": lunga durata, leggerezza, non graffiano e non arrugginiscono.

**TE** Brass plated crimped wire cup brushes.

**T50-75 A-B** Abrasive Nylon cup brushes with 6x30mm - 1/4"x1-1/4" shank. They are long lasting and light, they do not scratch or get rusted.

### Tazze in Acciaio Ottonato TE / Brass plated cup brushes TE

D		S		MAX RPM	Box Qty	ART	0,30mm	0,30mm
mm	inch	mm	inch				0,012"	0,012"
50	2	17	5/8	4500	30/240	<b>TE50</b>	<b>0660</b>	
50	2	17	5/8	4500	12/96	<b>TE50</b>		<b>2522</b>
50	2	17	5/8	4500	B/12/96	<b>B TE50</b>	<b>0200</b>	<b>0980</b>
75	3	25	1	4500	12/96	<b>TE75</b>	<b>0661</b>	<b>2526</b>
75	3	25	1	4500	B/12/96	<b>B TE75</b>	<b>0202</b>	<b>0985</b>
85	3-3/8	25	1	4500	B/6/48	<b>B TE85</b>	<b>0227</b>	

T75B



T50A

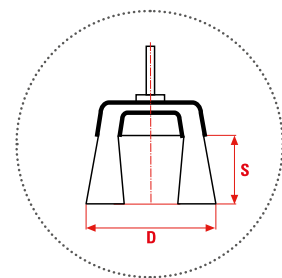

### Tazze in Nylon abrasivo / Abrasive Nylon cup brushes

D		S		MAX RPM	Box Qty	ART	Abrasit A	Abrasit B
mm	inch	mm	inch				120 gr	180 gr
50	2	16	5/8	4500	24/192	<b>T50A - T50B</b>	<b>0613</b>	<b>0623</b>
50	2	16	5/8	4500	B/6/48	<b>B T50A - B T50B</b>	<b>0614</b>	<b>0624</b>
75	3	24	1	4500	15/120	<b>T75A - T75B</b>	<b>0615</b>	<b>0625</b>
75	3	24	1	4500	B/6/48	<b>B T75A - B T75B</b>	<b>0616</b>	<b>0626</b>

### APPLICAZIONI / APPLICATIONS

**TE** Lavori leggeri di manutenzione e pulizia. Ideale per l'hobbista.

**T50-75 A-B** Ideali su pietra, mattoni, tegole, cemento, legno e metalli.

**TE** Light-duty jobs of maintenance and cleaning. They are perfect for all the hobbyists.

**T50-75 A-B** Ideal on stone, bricks, tiles, concrete, wood and metals.



# > Pennelli / End brushes



[www.sitbrush.tv/d3](http://www.sitbrush.tv/d3)

## DISEGNI TECNICI / TECHNICAL DRAWINGS

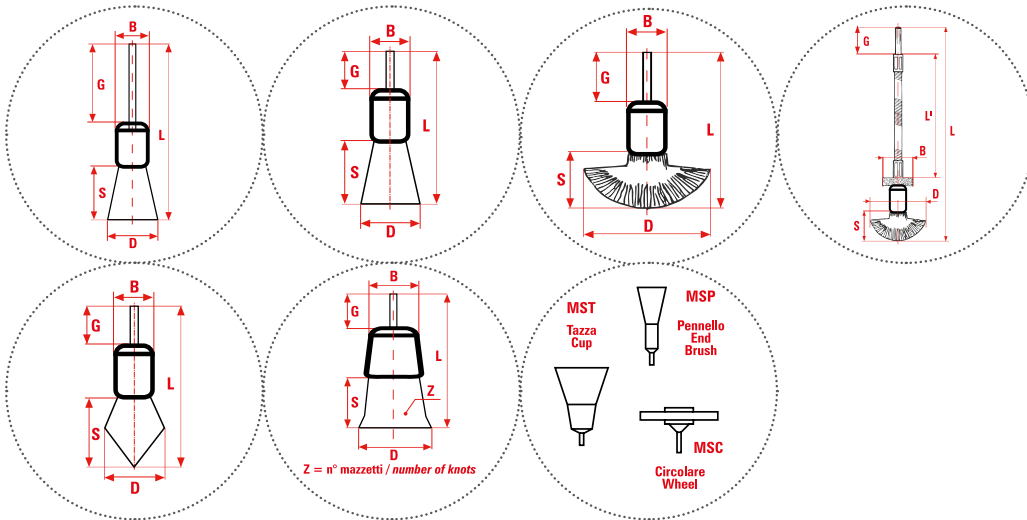

### LEGENDA PACK



**Blister**  
e.g. B/6/48  
Blister singolo in scatole da 6 pezzi con eventuale imballo secondario da 48 pezzi / Single blister pack in boxes containing 6 pcs with 48-pcs secondary packaging (if any)



**Multipack**  
e.g. 12/96  
Confezione multipla da 12 pezzi con eventuale imballo secondario da 96 pezzi / Multiple pack containing 12 pcs with 96-pcs secondary packaging (if any)

### LEGENDA FILO / FILAMENT



**Acciaio / Steel**  
Acciaio ottonato / Brass  
Plated Steel

**Inox / Stainless Steel**

**Ottone / Brass**

**Cordicella d'acciaio Liz / LIZ Steel Cord**

**Nylon abrasivo / Abrasive Nylon**  
Filamenti in Nylon abrasivo:  
O.A. = Ossido di Alluminio  
C.S. = Carburo di Silicio  
**Abrasil A:** Nylon abrasivo arancione (grana 120), più aggressivo.  
**Abrasil B:** Nylon abrasivo blu (grana 180), meno aggressivo.  
Abrasive Nylon filaments:  
O.A. = Aluminium Oxide  
C.S. = Silicon Carbide  
**Abrasil A:** Orange abrasive Nylon (120 grit), more aggressive.  
**Abrasil B:** Blue abrasive Nylon (180 grit), less aggressive.

## NOTE / NOTES

Se non indicato diversamente, i pennelli per trapano SIT hanno gambo Ø 6mm - 1/4".  
Unless otherwise noted, SIT end brushes for drill have shank Ø 6mm - 1/4".

.....

**Gli articoli con Ref ROSSA sono i più venduti / scelte consigliate**  
**Items marked in RED are ready for immediate shipment.**

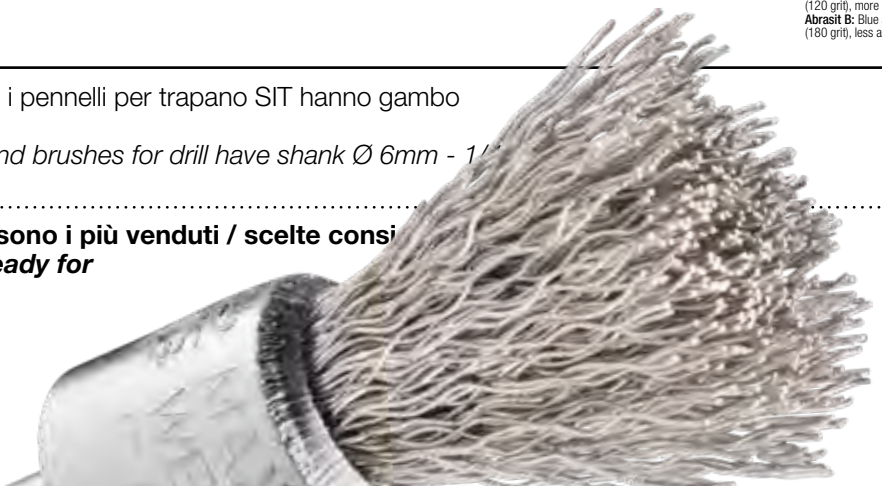

> Pennelli / End brushes



Spazzole a pennello in acciaio ondulato ad alta resistenza e altissima densità di filo, per lavori frontali con utensili elettrici e ad aria.

**PL15, PL20** Pennelli a gambo lungo in acciaio ottonato. Adatti a lavori in cavità profonde.

**P6** Pennello con filamento in tutta la lunghezza del corpo. Tagliare il gambo per regolare sporgenza e consumo.

End brushes made of highly resistant crimped steel wire with great wire density. Ideal for frontal jobs and mountable either on electric or air tools.

**PL15, PL20** Brass plated steel end brushes with long shank. Suitable to reach deep cavities.

**P6** End brush with filament across the length of the body. Cut the shank to adjust protrusion and wear.

**Pennelli in filo ondulato / Crimped wire end brushes**

D		G		B		S		L		MAX RPM	2	ART	0,15mm	0,30mm	0,15mm	0,30mm
mm	inch	mm	inch	mm	inch	mm	inch	mm	inch				0,006"	0,012"	0,006"	0,012"
4	5/32	55	2-1/8	6	1/4	10	3/8	65	2-1/2	20000	10	<b>P6</b>				<b>2493</b>
15	5/8	20	3/4	10	3/8	24	1	65	2-1/2	20000	12/96	<b>P10</b>	<b>0800</b>	<b>0801</b>	<b>0953</b>	<b>0954</b>
15	5/8	20	3/4	10	3/8	24	1	65	2-1/2	20000	B/6/48	<b>B P10</b>				<b>0955</b>
18	3/4	22	7/8	15	5/8	24	1	65	2-1/2	18000	12/96	<b>P15</b>	<b>0806</b>	<b>0807</b>	<b>0956</b>	<b>0957</b>
18	3/4	80	3-1/8	15	5/8	24	1	122	4-3/4	18000	12/96	<b>PL15</b>		<b>0825</b>		
22	7/8	18	3/4	20	3/4	27	1	70	2-3/4	18000	12/96	<b>P20</b>	<b>0813</b>	<b>0814</b>	<b>0961</b>	<b>0962</b>
22	7/8	80	3-1/8	20	3/4	27	1	129	5-1/8	18000	12/96	<b>PL20</b>		<b>0826</b>		
28	1-1/8	18	3/4	25	1	27	1	70	2-3/4	18000	12/96	<b>P25</b>	<b>0843</b>	<b>0820</b>	<b>0993</b>	<b>2495</b>
35	1-3/8	18	3/4	30	1-1/8	30	1-1/8	72	2-7/8	18000	12/96	<b>P30</b>	<b>0847</b>	<b>0822</b>	<b>0998</b>	<b>0981</b>

D		G		B		S		L		MAX RPM	2	ART	0,15mm	0,30mm	0,17mm
mm	inch	mm	inch	mm	inch	mm	inch	mm	inch				0,006"	0,012"	0,007"
15	5/8	20	3/4	10	3/8	24	1	65	2-1/2	20000	12/96	<b>P10</b>	<b>0804</b>	<b>0805</b>	<b>0802</b>
18	3/4	20	3/4	15	5/8	24	1	65	2-1/2	18000	12/96	<b>P15</b>	<b>0810</b>	<b>0811</b>	<b>0812</b>
22	7/8	18	3/4	20	3/4	27	1	70	2-3/4	18000	12/96	<b>P20</b>	<b>0817</b>	<b>0818</b>	<b>0819</b>
28	1-1/8	18	3/4	25	1	27	1	70	2-3/4	18000	12/96	<b>P25</b>		<b>0821</b>	
35	1-3/8	18	3/4	30	1-1/8	30	1-1/8	72	2-7/8	18000	12/96	<b>P30</b>		<b>0823</b>	

0820, 0822 Ø filo 0,35mm / wire Ø 0.35mm

0806, 0831, 0843, 0847 Acciaio ottonato / Brass Plated steel

P25 Liz



**APPLICAZIONI / APPLICATIONS**

Lavori frontali di sbavatura fori, manutenzione e pulizia di superfici di difficile accesso.

Frontal jobs of holes deburring, maintenance and cleaning of hard to reach surfaces.

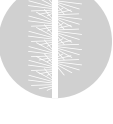

## > Pennelli / End brushes



**P24 HEX**

**PV22**

**PS30**

**PS** Pennelli in Nylon abrasivo ad altissima densità di filo, montabili su macchine CNC. Sono disponibili diverse grane.  
**PV** Pennelli in filo d'acciaio ottonato annegato in una soluzione poliuretanicca. Assicurano lunga durata, massima sicurezza e miglior precisione d'impiego.

**PS** Abrasive Nylon end brushes with high wire density, mountable on CNC machines. Different grits are available.  
**PV** End brushes made of brass plated crimped wire encapsulated in plastic material. They ensure a long service life, maximum safety and better precision.

### Pennelli ad attacco rapido P-HEX / Rapid load end brushes P-HEX

D		G		B		S		L		MAX RPM		ART	0,30mm	
mm	inch	mm	inch	mm	inch	mm	inch	mm	inch				0,012"	0,012"
28	1-1/8	25	1	24	1	27	1	81	3-1/4	4500	12/96	<b>P24 HEX</b>	<b>0824</b>	<b>2496</b>

### Pennelli in Nylon abrasivo PS / Abrasive Nylon end brushes PS

D		G		B		S		L		MAX RPM		ART	1mm - 0,040"	
mm	inch	mm	inch	mm	inch	mm	inch	mm	inch				C.S. 180 gr	0797
27	1	18	3/4	30	1-1/8	27	1	68	2-5/8	4500	12/96	<b>PS30</b>	<b>0797</b>	

### Pennelli vulcanizzati PV / Encapsulated end brushes PV

D		G		B		S		L		MAX RPM		ART	0,30mm	
mm	inch	mm	inch	mm	inch	mm	inch	mm	inch				0,012"	0793
24	1	16	5/8	22	7/8	24	1	65	2-1/2	20000	12/144	<b>PV22</b>	<b>0793</b>	

La linea HEX monta un gambo esagonale da 6,35mm - 1/4" che si adatta a qualsiasi tipo di mandrino o di avvitatore e permette l'attacco rapido.  
 The HEX line features a 6.35mm - 1/4" hexagonal shank that is suitable for any type of spindle or screwdriver and allows for quick coupling.

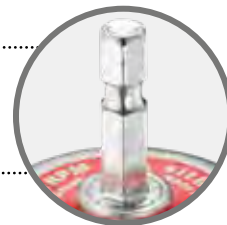

### APPLICAZIONI / APPLICATIONS

- PS** Sbavatura e finitura di metalli ferrosi e non ferrosi.
- PV** Operazioni di finitura che richiedono abrasione uniforme e superficie di lavoro definita.
- PS** Deburring and finishing of ferrous and non-ferrous metals.
- PV** Finishing operations that require regular abrasion.

# TRAPANO / DRILL

## > Pennelli / End brushes



PE25

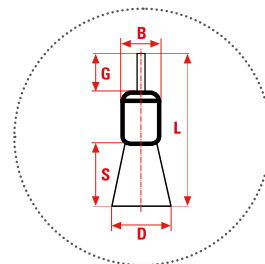

**PE** Pennelli in acciaio ottonato ondulato

**P20 A-B** Pennelli in Nylon abrasivo. Sono durevoli e leggeri, non graffiano e non arrugginiscono.

**PE** Brass plated crimped wire end brushes.

**P20 A-B** Abrasive Nylon end brushes. They are long lasting and light, they do not scratch or get rusted.

### Pennelli in acciaio ottonato PE / Brass plated end brushes PE

D		G		B		S		L		MAX RPM	2	ART	0,30mm	0,30mm
mm	inch	mm	inch	mm	inch	mm	inch	mm	inch				0,012"	0,012"
18	3/4	22	7/8	15	5/8	24	1	65	2-1/2	18000	48/384	<b>PE15</b>	<b>0794</b>	
18	3/4	22	7/8	15	5/8	24	1	65	2-1/2	18000	B/12/96	<b>B PE15</b>	<b>0209</b>	
22	7/8	18	3/4	20	3/4	27	1	70	2-3/4	18000	48/192	<b>PE20</b>	<b>0795</b>	
22	7/8	18	3/4	20	3/4	27	1	70	2-3/4	18000	12/96	<b>PE20</b>		<b>2528</b>
22	7/8	18	3/4	20	3/4	27	1	70	2-3/4	18000	B/6/48	<b>B PE20</b>		<b>0960</b>
28	1-1/8	20	3/4	25	1	27	1	70	2-3/4	18000	48/192	<b>PE25</b>	<b>0796</b>	
28	1-1/8	20	3/4	25	1	27	1	70	2-3/4	18000	B/12/96	<b>B PE25</b>	<b>0210</b>	

P20B



P20A

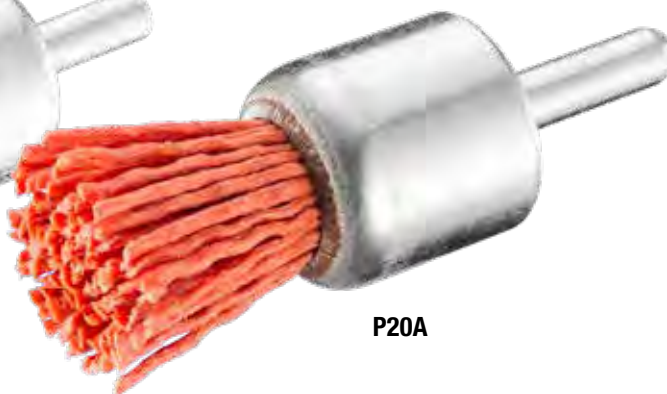

### Pennelli in Nylon abrasivo / Abrasive Nylon end brushes

D		G		B		S		L		MAX RPM	2	ART	Abrasit A	Abrasit B
mm	inch	mm	inch	mm	inch	mm	inch	mm	inch				120 gr	180 gr
22	7/8	21	7/8	22	7/8	22	7/8	74	2-7/8	4500	20/160	<b>P20A - P20B</b>	<b>0617</b>	<b>0627</b>
22	7/8	21	7/8	22	7/8	22	7/8	74	2-7/8	4500	B/6/48	<b>B P20A - B P20B</b>	<b>0618</b>	<b>0628</b>

### APPLICAZIONI / APPLICATIONS

**PE** Lavori leggeri di manutenzione e pulizia.

**P20A-B** Ideali su pietra, mattoni, tegole, cemento, legno e metalli.

**PE** Light maintenance and cleaning operations.

**P20A-B** Ideal on stone, bricks, tiles, concrete, wood and metals.

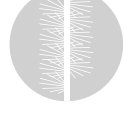

# TRAPANO / DRILL

TECH

## > Pennelli / End brushes

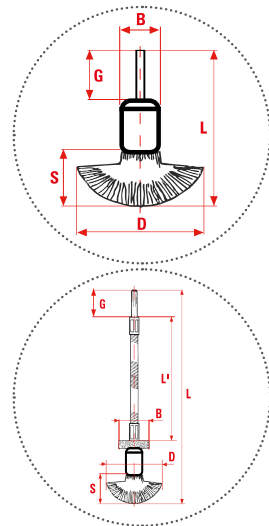
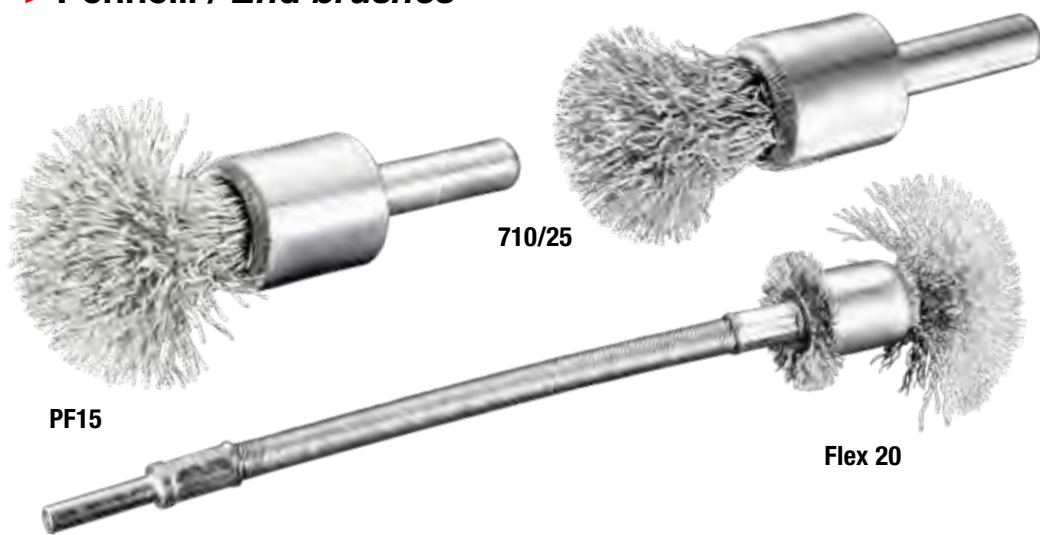

**PF** Pennelli in acciaio ondulato ad alta resistenza ed altissima densità di filo. La forma a fungo li rende adatti per lavori di pulizia in zone concave.

**FLEX** Il gambo lungo e flessibile lo rende adatto per lavori in cavità profonde, difficili da raggiungere e non allineate.

**PF** Highly resistant crimped wire end brushes with high wire density. The mushroom shape makes them suitable for cleaning inside cavities.

**FLEX** The long and flexible shank is suitable for jobs in deep cavities and out-of-line areas.

### Pennelli a fungo / Mushroom shaped flared end brushes

D		G		B		S		L		MAX RPM		ART	0,30mm
mm	inch	mm	inch	mm	inch	mm	inch	mm	inch				0,012"
35	1-3/8	22	7/8	15	5/8	25	1	61	3-3/8	18000	12/96	<b>PF15</b>	<b>0831</b>
50	2	18	3/4	20	3/4	25	1	65	2-1/2	18000	12/96	<b>PF20</b>	<b>0832</b>
60	2-3/8	18	3/4	30	1-1/8	30	1-1/8	72	2-7/8	15000	12/96	<b>PF30</b>	<b>0833</b>
23	7/8	22	7/8	15	5/8	22	7/8	61	3-3/8	18000	12/96	<b>710/25</b>	<b>0834</b>
30	1-1/8	22	7/8	15	5/8	25	1	65	2-1/2	18000	12/96	<b>710/30</b>	<b>0835</b>
40	1-5/8	22	7/8	20	3/4	35	1-3/8	72	2-7/8	18000	12/96	<b>710/40</b>	<b>0836</b>

### Pennelli flex / Flex end brushes

D		G		B		S		L		L'		MAX RPM		ART	0,30mm
mm	inch	mm	inch	mm	inch	mm	inch	mm	inch	mm	inch				0,012"
50	2	25	1	30	1-1/8	27	1	230	9	150	6	12000	12	<b>FLEX20</b>	<b>0827</b>

Ricambi fungo / Spare parts - mushroom shaped brush

12000 24

**RICAMBI FUNGO** **0828**

Ricambi anello / Spare parts - Single section wheel B = 30mm - 1-1/8"

12000 24/288

**RICAMBI ANELLO 6/30** **0829**



### APPLICAZIONI / APPLICATIONS

**PF** Autofficina - manutenzione dei motori.

**FLEX** Lavori frontali di sbavatura fori, manutenzione, pulizia di superfici e cavità di difficile accesso.

**PF** Workshop - engines maintenance.

**FLEX** Frontal jobs of holes deburring, maintenance and cleaning of hard to reach surfaces and cavities.



**> Pennelli / End brushes**

**P10 punta 30°  
Acciaio ottonato /  
Brass Plated Steel**



**P10 punta Acciaio  
ottonato / Brass Plated  
Steel**

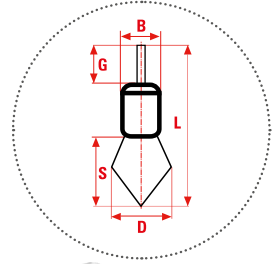

**P15 punta Acciaio ottonato /  
Brass Plated Steel**



**P20 punta INOX / S. Steel**



Pennelli in acciaio ondulato ad alta resistenza ed altissima densità di filo. La punta da 90° li rende adatti a lavori di precisione.

Highly resistant crimped wire end brushes with high wire density. The tip end of 90° makes them suitable for precision operations.

**Pennelli a punta / Tip end brushes**

D		G		B		S		L		MAX RPM		ART	0,30mm	0,30mm
mm	inch	mm	inch	mm	inch	mm	inch	mm	inch				0,012"	0,012"
10	3/8	23	7/8	10	3/8	25	1	105	4-1/8	20000	12/96	<b>PL10 PUNTA 30°</b>	<b>0912</b>	<b>0952</b>
12	1/2	23	7/8	10	3/8	25	1	105	4-1/8	20000	12/96	<b>PL10 PUNTA</b>	<b>0842</b>	<b>0852</b>
10	3/8	20	3/4	10	3/8	25	1	65	2-1/2	20000	12/96	<b>P10 PUNTA 30°</b>	<b>0803</b>	<b>0808</b>
12	1/2	20	3/4	10	3/8	25	1	65	2-1/2	20000	12/96	<b>P10 PUNTA</b>	<b>0892</b>	<b>0872</b>
18	3/4	22	7/8	15	5/8	26	1	65	2-1/2	18000	12/96	<b>P15 PUNTA</b>	<b>0830</b>	<b>0838</b>
22	1-1/8	18	3/4	20	3/4	27	1	69	2-3/4	18000	12/96	<b>P20 PUNTA</b>	<b>0815</b>	<b>0816</b>

**PL10 punta 30° INOX / S. Steel**



**PL10 punta Acciaio ottonato / Brass  
Plated Steel**



**APPLICAZIONI / APPLICATIONS**

Eliminazione di scorie, di bave e di vernice da superfici interne e di difficile accesso. Ideali per lavori ad alte velocità.  
Burs, slags and paint removal from internal and hard to reach surfaces. Ideal for high speed operations.

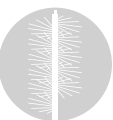

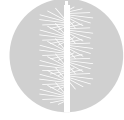

# TRAPANO / DRILL

TECH

## > Pennelli / End brushes



Spazzole a pennello in acciaio ad altissima resistenza. Molto aggressive. Variano il diametro di lavoro a seconda degli RPM usati.

Aggressive end brushes made of highly resistant steel wire. The working diameter changes according to the RPM in use.

### Pennelli a mazzetti ritorti PZ / Twist knot end brushes PZ

D		G		B		S		L		Z	MAX RPM	Box 2	ART	0,25mm		0,35mm		0,50mm	
mm	inch	mm	inch	mm	inch	mm	inch	mm	inch					0,010"	0,014"	0,020"	0,010"	0,014"	
6	1/4	18	3/4	10	3/8	25	1	66	2-5/8	1	4500	10	PZ6		2489				2490
19	3/4	16	5/8	19	3/4	28	1-1/8	70	2-3/4	6	20000	12/96	PZ19	0837				0959	
20	3/4	16	5/8	22	7/8	28	1-1/8	71	2-3/8	8	20000	12/96	PZ20	0839	0840	0841	0963	0964	
30	1-1/8	16	5/8	28	1-1/8	28	1-1/8	73	2-7/8	12	20000	12/96	PZ30	0844	0845	0846	0982	0983	

Tutti i pennelli a mazzetti ritorti sono disponibili, a richiesta, con filo 0,15mm / All the twist knot end brushes are available, on request, with 0,006" steel wire

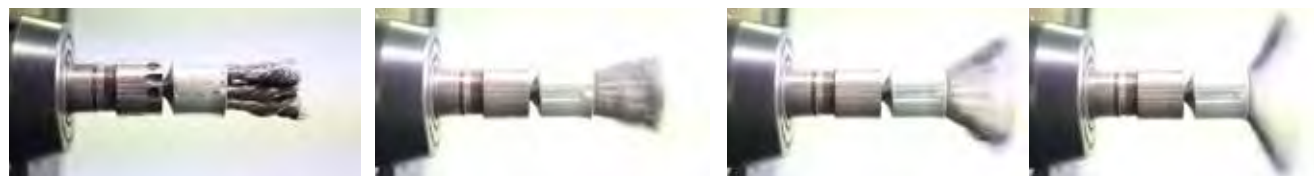

### APPLICAZIONI / APPLICATIONS

Lavori frontali di grossa sbavatura fori, manutenzione e pulizia.  
Heavy duty jobs of holes deburring, maintenance and cleaning.



# TRAPANO / DRILL

## > Mini Spazzole / Mini brushes



Una serie completa di mini spazzole per lavori di precisione e modellismo.

A complete set of tiny brushes best for precise operations and modeling.

### Mini spazzole con gambo Ø 2,35mm - 3/32" / Mini brushes with shank Ø 2,35mm - 3/32"

D		Shank		MAX RPM		ART	0,10mm	0,08mm
mm	inch	mm	inch				0,004"	0,003"
19	3/4	2,35	3/32	4500	10/100	<b>MSC</b>	<b>3501</b>	<b>3502</b>
12	1/2	2,35	3/32	4500	10/100	<b>MST</b>	<b>3511</b>	<b>3512</b>
8	5/16	2,35	3/32	4500	10/100	<b>MSP</b>	<b>3521</b>	<b>3522</b>

D		Shank		MAX RPM		ART	Setola bianca	Setola nera	Cotone	Scotch brite
mm	inch	mm	inch				White bristle	Black bristle	Cotton	
22	7/8	2,35	3/32	4500	10/100	<b>MSC</b>	<b>3503</b>	<b>3504</b>	<b>3505</b>	
25	1	2,35	3/32	4500	10/100	<b>MSC</b>				<b>3506</b>
12	1/2	2,35	3/32	4500	10/100	<b>MST</b>	<b>3513</b>	<b>3514</b>		
8	5/16	2,35	3/32	4500	10/100	<b>MSP</b>	<b>3523</b>	<b>3524</b>		

**Acciaio:** per rimuovere incrostazioni e asportare.

**Ottone:** per lucidare.

**Setola Bianca e Nera:** per sgrassatura con paste.

**Cotone:** per brillantatura con paste.

**Scotch Brite:** per satinare e preparare le saldature.

**Steel:** pickling and deposits removal

**Brass:** polishing

**Black and White Bristle:** roughing with paste.

**Cotton:** buffing with paste.

**Scotch Brite:** satin finishing and welding preparation.

### APPLICAZIONI / APPLICATIONS

Per Hobbistica, modellismo e lavorazioni di finitura su stampi.  
Ideal for hobby crafts, model working and mould finishing.



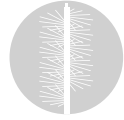

# TRAPANO / DRILL

## > Box misti / Mixed boxes



**Box Super 5** Pratico Display Box contenenti 8 pezzi per tipo delle spazzole per trapano più utilizzate.

**Box Abrasit** Box contenente 20 spazzole assortite (2 pz per ogni referenza) in nylon abrasivo. Di lunga durata, leggere, non graffiano e non arrugginiscono.

**Box HEX** Box contenente 12 spazzole assortite (4 pezzi per ogni referenza) con gambo ad attacco rapido esagonale da 6,35mm - 1/4", per un più rapido serraggio e risparmio nei tempi di setup.

**Super 5 box** Handy Display Box containing 8 pieces of the most used drill brushes.

**Box Abrasit** Box containing 20 mixed brushes (2 pcs for each part) made of abrasive nylon. Long lasting and light; they don't scratch or get rusted.

**Box HEX** Box containing 12 assorted brushes (4 pieces for each reference) and 6.35mm - 1/4" hexagonal shanks with quick coupling for faster tightening and shorter setup time.

### Box misti trapano / Mixed boxes for drill

Contenuto / Contents	ART	0,30mm - 0,012"	Abrasit A (120gr) Abrasit B (180gr)
8 G50 (Ref 0887) + 8 G60 (Ref 0888) + 8 TE50 (Ref 0660) + 8 TE75 (Ref 0661) + 8 PE20 (Ref 0795)	1/8 <b>SUPER 5</b>	<b>0895</b>	
2 G75A (Ref 0609) + 2 G75B (Ref 0619) + 2 G100A (Ref 0611) + 2 G100B (Ref 0621) + 2 T50A (Ref 0613) + 2 T50B (Ref 0623) + 2 T75A (Ref 0615) + 2 T75B (Ref 0625) + 2 P20 A (Ref 0617) + 2 P20B (Ref 0627)	1/8 <b>BOX ABRASIT</b>		<b>0645</b>

### Box HEX

Contenuto / Contents	ART	0,30mm - 0,012"	TECH
4 GG52HEX (Ref 0864) + 4 T60HEX (Ref 0656) + 4 P24HEX (Ref 0824)	1/8 <b>BOX HEX</b>	<b>0897</b>	

### Box Clepsydra

Contenuto / Contents	ART	REF
5 Clepsydra Acciaio/Steel (Ref 0880) + 5 Clepsydra Inox (Ref 0891) + 5 Clepsydra Ottone/Brass (Ref 0883) + 5 Clepsydra Nylon (Ref 0893)	1/8 <b>BOX CLEPSYDRA 8pz</b>	<b>0338</b>



### APPLICAZIONI / APPLICATIONS

Ideali per lavori leggeri di manutenzione e pulizia.  
Ideali su pietra, mattoni, tegole, cemento, legno e metalli.  
Suitable for light maintenance and cleaning jobs.  
Ideal on stone, bricks, tiles, concrete, wood and metals.





# MOLA BENCH GRINDER

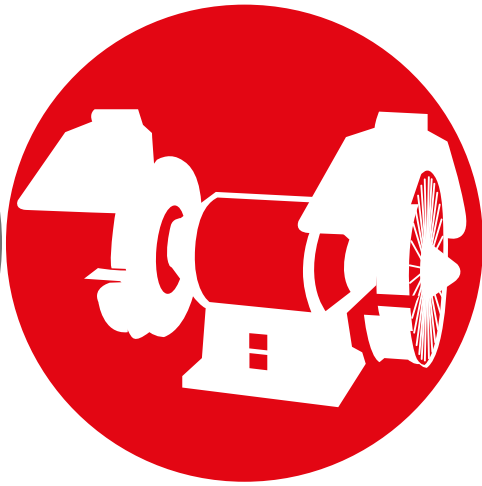

## SPAZZOLE CIRCOLARI / WHEEL BRUSHES

p. 69



> Spazzole circolari  
*Wheel brushes*

p. 70



> Spazzole circolari di ampio spessore  
*Wide face wheel brushes*

p. 73



> Riduzioni  
*Adapters*

p. 77



## ANELLI / SINGLE SECTION WHEELS

p. 76



> Anelli  
*Single section wheels*

p. 78



> Spazzole circolari  
*Wheel brushes*

p. 82

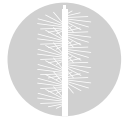

# > Spazzole circolari / Wheel brushes



[www.sitbrush.tv/b1](http://www.sitbrush.tv/b1)

## DISEGNI TECNICI / TECHNICAL DRAWINGS

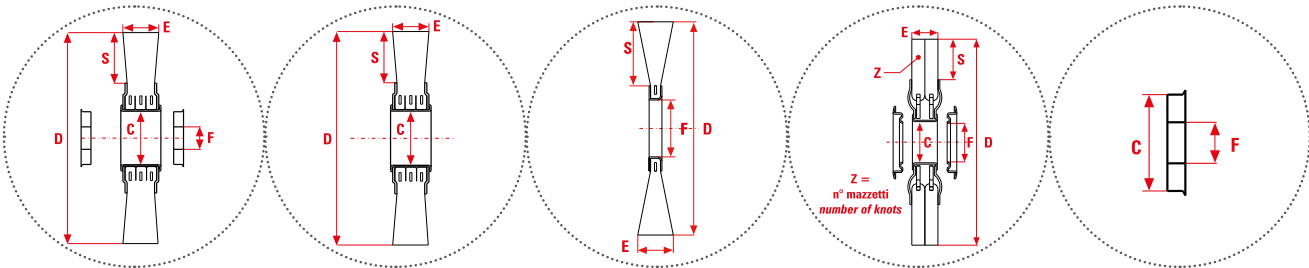

### LEGENDA PACK



#### Single pack e.g. 1/10

Confezione singola con eventuale imballo secondario da 10 pezzi / Single pack with 10-pcs secondary packaging (if any)

#### Blister pack e.g. B/6/48

Blister singolo in scatole da 6 pezzi con eventuale imballo secondario da 48 pezzi / Single blister pack in boxes containing 6pcs with 48-pcs secondary packaging (if any)

#### Multipack e.g. 5/40

Confezione multipla da 5 pezzi con eventuale imballo secondario da 40 pezzi / Multiple pack containing 5 pcs with 40-pcs secondary packaging (if any)

### LEGENDA FILO / FILAMENT



#### Acciaio / Steel

Acciaio  
ottonato  
/ Brass  
Plated Steel

#### Inox / Stainless Steel

#### Ottone / Brass

#### Cordicella d'acciaio Liz / LIZ Steel Cord

#### Nylon abrasivo / Abrasive Nylon

Filamenti in Nylon abrasivo:  
O.A. = Ossido di Alluminio  
C.S. = Carburio di Silicio  
CERAMIC = grana abrasiva ceramica  
Abrasive Nylon filaments:  
O.A. = Aluminium Oxide  
C.S. = Silicon Carbide  
CERAMIC = abrasive ceramic grit

## NOTE / NOTES

A parità di diametro esterno, si possono avere fino al 67% di filamenti in più tra serie diverse. Un'alta densità di filamento comporta maggiore aggressività e durata della spazzola (Vedi pag. 76).

*With the same outer diameter it's possible to have up to 67% more filaments among different ranges. Increased wire density ensures greater aggressiveness and longer brush life (See page 76).*



La cordicella LIZ conferisce grandissima flessibilità e la possibilità di ottenere diversi tipi di finitura a seconda della pressione esercitata. È ideale per lavorazioni su gomma, ma è adatta ad ogni tipo di superficie.

*The brass plated LIZ cord gives great flexibility and enables different kinds of finishing, depending on the applied pressure. It is ideal for rubber processing, but it is also suitable for any other material.*

### KIT mm - KIT inch

Multi-adattatore per foro interno (Vedi pag. 75).  
Multi-adapter for inner diameter (See page 75).

**Gli articoli con Ref ROSSA sono i più venduti / scelte consigliate**  
**Items marked in RED are the best sellers / recommended choice**





## > Spazzole circolari / Wheel brushes

4153 inox

4183

6153



Spazzole circolari in filo d'acciaio ondulato ad alta resistenza e ad altissima densità di filamento.

Highly resistant crimped wire wheel brushes with very high wire density.

### Circolari serie 3000, 4000, 6000\*\* / Wheel brushes range 3000, 4000, 6000\*\*

D		E		S		C		F		MAX RPM		ART	0,20mm	0,35mm	0,50mm	0,30mm	0,30mm
mm	inch	mm	inch	mm	inch	mm	inch	mm	inch				0,008"	0,014"	0,020"	0,012"	0,012"
100	4	15	9/16	18	11/16	28	1-1/8	16	5/8	6000	1/36	3102	0048	0050*	0051		0911
100	4	20	3/4	18	11/16	28	1-1/8	16	5/8	6000	1/36	3103		0053*			9111
125	5	17	11/16	30	1-3/16	28	1-1/8	16	5/8	6000	1/32	3122	0049	0054*			
125	5	17	11/16	30	1-3/16	28	1-1/8	16	5/8	6000	B/6/48	B 3122					0915
125	5	25	1	30	1-3/16	28	1-1/8	16	5/8	6000	1/32	3123	9119	0055*	0056		0914
150	6	20	3/4	32	1-1/4	38	1-1/2	KIT	mm	6000	1/16	4152	9125	0058		9128	9129
150	6	20	3/4	32	1-1/4	38	1-1/2	KIT	mm	6000	B/6/48	B 4152					0920
150	6	20	3/4	32	1-1/4	38	1-1/2	KIT	inch	6000	1/16	4152		9058			
150	6	27	1-1/16	32	1-1/4	38	1-1/2	KIT	mm	6000	1/16	4153	0059	0060	0061	9134	0916
150	6	27	1-1/16	32	1-1/4	38	1-1/2	KIT	mm	6000	1/16	4153 super inox					0996
150	6	27	1-1/16	32	1-1/4	38	1-1/2	KIT	inch	6000	1/16	4153		9060			9916
150	6	35	1-3/8	32	1-1/4	38	1-1/2	KIT	mm	6000	1/16	4154		0064			
150	6	25	1	25	1	58	2-5/16	KIT	mm	6000	1/16	6153**		0065			
180	7-1/8	20	3/4	47	1-13/16	38	1-1/2	KIT	mm	6000	1/10	4182		0067		9152	
180	7-1/8	27	1-1/16	47	1-13/16	38	1-1/2	KIT	mm	6000	1/10	4183	9155	0068	0069	9158	0917
180	7-1/8	25	1	30	1-3/16	58	2-5/16	KIT	mm	6000	1/10	6183**		0071			
200	8	23	7/8	47	1-13/16	38	1-1/2	KIT	mm	6000	1/10	4202		0072		9176	9177
200	8	23	7/8	47	1-13/16	38	1-1/2	KIT	inch	6000	1/10	4202		9072			
200	8	29	1-1/8	47	1-13/16	38	1-1/2	KIT	mm	6000	1/10	4203	0073	0074	0075	9182	0921
200	8	29	1-1/8	47	1-13/16	38	1-1/2	KIT	mm	6000	1/10	4203 super inox					0997
200	8	29	1-1/8	47	1-13/16	38	1-1/2	KIT	inch	6000	1/10	4203		9074			9921
200	8	36	1-7/16	47	1-13/16	38	1-1/2	KIT	mm	6000	1/10	4204		0078		9188	
200	8	30	1-3/16	40	1-9/16	58	2-5/16	KIT	mm	6000	1/10	6203**		0079	0080	9194	0922
250	10	30	1-3/16	65	2-9/16	58	2-5/16	KIT	mm	6000	2	6253		0082	0083		0923
250	10	30	1-3/16	65	2-9/16	58	2-5/16	KIT	inch	6000	2	6253		9082			9923
250	10	30	1-3/16	65	2-9/16	58	2-5/16	KIT	mm	6000	2	6254		0085			

### Circolari serie 3000, 4000 / Wheel brushes range 3000, 4000

D		E		S		C		F		MAX RPM		ART	0,30mm	0,30mm
mm	inch	mm	inch	mm	inch	mm	inch	mm	inch				0,012"	0,012"
125	5	25	1	30	1-3/16	28	1-1/8	16	5/8	6000	1/32	3123		9638
150	5	27	1-1/16	32	1-1/4	38	1-1/2	KIT	mm	6000	1/16	4153	0063	9639
200	8	29	1-1/8	47	1-13/16	38	1-1/2	KIT	mm	6000	1/10	4203	0077	9640

\*\*A parità di diametro, la serie 6000 presenta il 50% di filamenti in più ed è adatta a impieghi industriali. / With the same outer diameter, range 6000 has 50% more filaments. Ideal for industrial use.

4153 super inox flange Ø 86mm - 3-3/8" / flanges Ø 86mm - 3-3/8".

4203 super inox flange Ø 106mm - 4-1/8" / flanges Ø 106mm - 4-1/8".

Le versioni in Ottone sono Antiscintilla. The Brass items are Anti-sparks.

### APPLICAZIONI / APPLICATIONS

Sbavatura, satinatura e lucidatura di superfici di ogni materiale e forma. Deburring, satin finishing and polishing of surfaces of any kind and material.



## > Spazzole circolari / Wheel brushes

4203

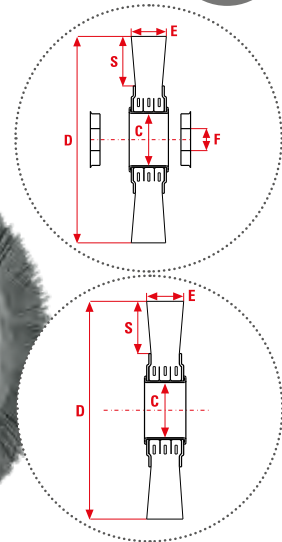

Spazzole circolari in Nylon abrasivo adatte ad ogni tipo di superficie metallica e non. Circolari in Nylon abrasivo ceramico: azioni di taglio dalle 3 alle 5 volte più rapide dei filamenti abrasivi tradizionali, autoaffilatura, finitura di metalli duri.

Abrasive nylon wheel brushes suitable for any kind of metal and non-metal surface. Ceramic abrasive nylon wheel brushes: 3 to 5 times faster cutting compared to traditional abrasive filaments. Self-threading, finishing of hard metals.

### Circolari in Nylon Abrasivo / Abrasive nylon wheel brushes

D		E		S		C		F		MAX RPM	ART	1mm-0,040" 0,55mm-0,022" 1mm-0,040" 0,5mm-0,020" 0,25mm-0,009"						
mm	inch	mm	inch	mm	inch	mm	inch	mm	inch			C.S. 80gr	C.S. 120gr	C.S. 180gr	C.S. 500gr	O.A. 800gr		
80	3-3/16	15	9/16			10	3/8	10	3/8	4000	1/24	<b>1080</b>			<b>0692</b>			
150	6	25	1	30	2-3/16	38	1-1/2	KIT mm		6000	1/16	<b>4153</b>			<b>0062</b>			
150	6	15	9/16	25	1	22,2	7/8			9000	6/24	<b>6151</b>	<b>5100</b>	<b>5102</b>	<b>5105</b>	<b>2501</b>	<b>2503</b>	
150	6	20	3/4	25	1	50,8	2			9000	6/24	<b>6152</b>	<b>5211</b>	<b>5212</b>	<b>5213</b>	<b>5214</b>	<b>5215</b>	
200	8	25	1	45	2-3/4	38	1-1/2	KIT mm		6000	1/10	<b>4203</b>			<b>0076</b>			

### Circolari in Abrasivo Ceramico / Ceramic Abrasive wheel brushes

D		E		S		C		MAX RPM	ART	1mm-0,040" 0,7mm-0,027" 0,90mm-0,037" 0,55mm-0,022" 0,55mm-0,022"					
mm	inch	mm	inch	mm	inch	mm	inch			80gr	120gr	180gr	220gr	320gr	
150	6	15	9/16	25	1	22,2	7/8	9000	6/24	<b>6151</b>	<b>5175</b>	<b>5176</b>	<b>5177</b>	<b>5221</b>	<b>2509</b>
150	6	20	3/4	25	1	50,8	2	9000	6/24	<b>6152</b>	<b>5178</b>	<b>5179</b>	<b>5180</b>	<b>5222</b>	<b>5181</b>

\*6151 Abrasiva Disponibili su richiesta altre tipologie e dimensioni di filamento e grana abrasiva / Other sizes and filament and abrasive grain types available on request  
 1080 È la spazzola più utilizzata nelle macchine per sbavatura chiavi / Is the most commonly used brush for key deburring machines.

Altre spazzole con filamento abrasivo ceramico studiate per la sbavatura all'interno del centro di lavoro sono disponibili nella categoria "Scovoli" a pag. 100 e nella categoria "Soluzioni Tecniche" a pag. 162. / Other brushes with ceramic abrasive filaments designed for deburring in machining centres are available in the "Twisted-in brushes" category on page 100 and in the "Technical Solutions" category on page 162.



### APPLICAZIONI / APPLICATIONS

Sbavare, satinare, lucidare e rusticare superfici di ogni materiale e forma. Sbavare fessure, scanalature e tracce di fresa, sbavare ingranaggi (profili dentatura), raggiare spigoli, finitura superficiale metalli duri.

Deburring, satin finishing, polishing and aging surfaces of any shape and material. Deburring cracks, grooves and traces of milling cutters, deburring gears (toothing profiles), bevelling edges, surface finishing of hard metals.





## > Spazzole circolari / Wheel brushes

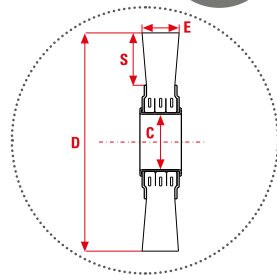
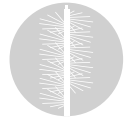

Spazzole circolari in Nylon abrasivo adatte ad ogni tipo di superficie metallica e non. Circolari in Nylon abrasivo ceramico: azioni di taglio dalle 3 alle 5 volte più rapide dei filamenti abrasivi tradizionali, autoaffilatura, finitura di metalli duri.

Abrasive nylon wheel brushes suitable for any kind of metal and non-metal surface. Ceramic abrasive nylon wheel brushes: 3 to 5 times faster cutting compared to traditional abrasive filaments. Self-threading, finishing of hard metals.

### Circolari in Abrasivo Ceramico / Ceramic Abrasive wheel brushes



D		E		S		C		MAX RPM		ART	0,7mm-0,027" 0,90mm-0,037" 0,55mm-0,022" 0,55mm-0,022"			
mm	inch	mm	inch	mm	inch	mm	inch				120gr	180gr	220gr	320gr
75	3	9	3/8			13	1/2	4000	4/24	<b>C75</b>	<b>5182</b>	<b>5183</b>	<b>5192</b>	<b>5184</b>
100	4	6	1/4	20	3/4	13	1/2	4000	4/12	<b>C100</b>	<b>5185</b>	<b>5186</b>	<b>5193</b>	<b>5187</b>
125	4	6	1/4			13	1/2	4000	4/12	<b>C125</b>	<b>5188</b>	<b>5189</b>	<b>5194</b>	<b>5190</b>

### Circolari composite in Abrasivo Ceramico / Ceramic Abrasive Composite wheel brushes



D		E		S		C		MAX RPM		ART	1mm-0,040"	1mm-0,040"	0,9mm-0,037"
mm	inch	mm	inch	mm	inch	mm	inch				80gr	120gr	180gr
102	4	12	15/32	25	1	16	5/8	10000	1	<b>CC100</b>	<b>5191</b>	<b>0594</b>	<b>0595</b>
152	6	25	1	32	1-1/4	51	2	3600	1	<b>CC150</b>	<b>0593</b>	<b>0596</b>	<b>0597</b>

Altre spazzole con filamento abrasivo ceramico studiate per la sbavatura all'interno del centro di lavoro sono disponibili nella categoria "Scovoli" a pag. 100 e nella categoria "Soluzioni Tecniche" a pag. 162. / Other brushes with ceramic abrasive filaments designed for deburring in machining centres are available in the "Twisted-in brushes" category on page 100 and in the "Technical Solutions" category on page 162.



### APPLICAZIONI / APPLICATIONS

Sbavare, satinare, lucidare e rusticare superfici di ogni materiale e forma. Sbavare fessure, scanalature e tracce di fresa, sbavare ingranaggi (profili dentatura), raggiare spigoli, finitura superficiale metalli duri. Deburring, satin finishing, polishing and aging surfaces of any shape and material. Deburring cracks, grooves and traces of milling cutters, deburring gears (toothing profiles), bevelling edges, surface finishing of hard metals.

## > Spazzole circolari di ampio spessore / Wide face wheel brushes



10305



RW 6152

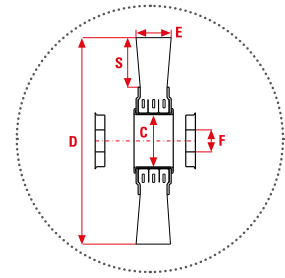

**10000 12000** Spazzole circolari in filo d'acciaio ondulato. Le nuove serie 10-12000 hanno una maggiore densità, una minore sporgenza e flange di diametro maggiore. Queste caratteristiche assicurano una maggiore aggressività e durata.  
**RW** La cordicella LIZ conferisce grandissima resistenza, grandissima flessibilità e la possibilità di ottenere diversi tipi di finitura a seconda della pressione esercitata.

**10000 12000** Crimped steel wire wheel brushes. The new 10-12.000 ranges have higher wire density, shorter trim length and wider face plates. These features ensure increased aggressiveness and longer lifetime.  
**RW** The brass plated LIZ cord gives great flexibility and enables different kinds of finishing, depending on the applied pressure.

### Circolari serie 10-12000 / Wheel brushes range 10-12000

D		E		S		C		F		MAX RPM	ART	Wire Diameter			
mm	inch	mm	inch	mm	inch	mm	inch	mm	inch			0,35mm	0,50mm	0,30mm	
250	10	45	1-3/4	35	1-3/8	100	4	80	3-1/8	3600	1	10255	0,014"	0,020"	0,012"
250	10	45	1-3/4	35	1-3/8	100	4	100	4	3600	1	10255	0095*	9210	
300	12	35	1-3/8	60	2-3/8	100	4	30	1-1/8	3000	1	10302	0086	0087	0924
300	12	42	1-5/8	60	2-3/8	100	4	30	1-1/8	3000	1	10303	0089		
300	12	56	2-1/4	60	2-3/8	100	4	2"+2ch		3000	1	10305	9234*		
300	12	56	2-1/4	60	2-3/8	100	4	100	4	3000	1	10305	9235		
350	14	50	2	85	3-3/8	120	4-3/4	30	1-1/8	2400	1	12354	9258	9259	

\* Ref 0095 e 9234 Equilibratura dinamica G 6,3 - ISO1940 / Dynamic balancing G 6,3 - ISO1940

### Circolari RW / Wheel brushes RW

D		E		S		C		MAX RPM	ART	Wire Diameter	
mm	inch	mm	inch	mm	inch	mm	inch			0,17mm	0,007"
140	5-1/2	32	1-1/4	20	3/4	58	2-1/4	6000	1	RW 6144	9603
150	6	18	3/4	25	1	58	2-1/4	6000	1	RW 6152	9606
150	6	43	1-3/4	15	9/16	77	3	6000	1	RW 8154	9609
160	6-1/4	45	1-3/4	20	3/4	77	3	6000	1	RW 8165	9611
200	7-7/8	44	1-3/4	29	1-1/8	100	4	6000	1	RW 10204	9619
230	9	55	2-1/8	25	1	100	4	6000	1	RW 10236	9624



### APPLICAZIONI / APPLICATIONS

**10000 12000** Sbavatura, satinatura e lucidatura di superfici di ogni materiale e forma  
**RW** Sbavature, satinature e decapaggio meccanico. Il Liz è ideale per raspatrici di pneumatici e industria della gomma.  
**10000 12000** Deburring, satin finishing and polishing of any kind of surface and material.  
**RW** Deburring, satin finishing and mechanical pickling. Liz steel cord is ideal for tyres buffing machines and for tyre industry.





# MOLA / BENCH GRINDER



## > Spazzole circolari / Wheel brushes



1050

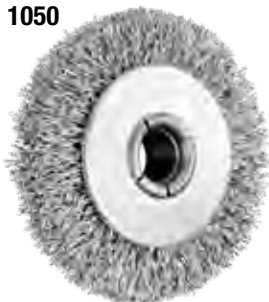

1080



C100

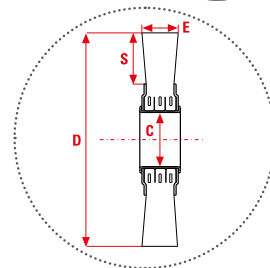

Spazzole in filo d'acciaio ottonato e Nylon compatibili con i maggiori macchinari per chiavi presenti sul mercato.

Brass plated steel and Nylon wire compatible with the most popular key machines in the world.



### Circolarine per macchine per chiavi / Wheel brushes for key machines

D		E		S		C		MAX RPM		ART	0,30mm	1mm - 0,040"
mm	inch	mm	inch	mm	inch	mm	inch				0,012"	C.S. 180 gr
55	2-1/8	13	1/2	10	3/8	10	3/8	4000	4/36	<b>1050</b>	<b>0690</b>	
75	3	9	3/8	16	5/8	10	3/8	4000	4/24	<b>C75</b>	<b>0691</b>	
80	3-1/8	15	5/8	15	5/8	10	3/8	4000	1/24	<b>1080</b>		<b>0692</b>
100	4	6	1/4	20	3/4	13	1/2	4000	4/12	<b>C100</b>	<b>0693</b>	

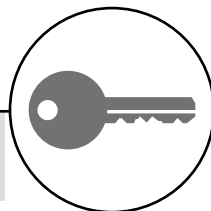

C75, C100 Acciaio ottonato / Brass plated steel.

1080 è la spazzola più utilizzata nelle macchine per sbavatura chiavi / is the most used brush for key deburring machines.



### APPLICAZIONI / APPLICATIONS

Ideali per la sbavatura, finitura e lucidatura delle chiavi, grazie all'alta densità di filamento.

Ideal for the deburring, satin finishing and polishing of the keys, thanks to the high wire density.



# MOLA / BENCH GRINDER

## > Spazzole circolari / Wheel brushes

CE4153



CE4203

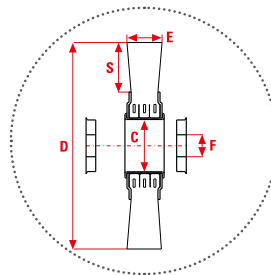

Spazzole circolari in filo d'acciaio ottonato ondulato. La serie CE comprende spazzole più leggere, con minore densità di filo.

Crimped brass plated steel wire wheel brushes. The CE range includes lighter brushes, with lower wire density.

### Circolari CE / Wheel brushes CE

D		E		S		C		F		MAX RPM		ART	0,30mm
mm	inch	mm	inch	mm	inch	mm	inch	mm	inch				0,012"
100	4	17	5/8	25	1	-	-	13	1/2	6000	5/40	<b>CE100</b>	<b>0703</b>
100	4	17	5/8	25	1	-	-	13	1/2	6000	B/6/48	<b>B CE100</b>	<b>0214</b>
100	4	23	7/8	19	3/4	28	1-1/8	16	5/8	6000	5/40	<b>CE3103</b>	<b>0704</b>
100	4	23	7/8	19	3/4	28	1-1/8	16	5/8	6000	B/6/48	<b>B CE3103</b>	<b>0705</b>
120	4-3/4	15	9/16	35	1-3/8	-	-	16	5/8	6000	5/40	<b>CE120</b>	<b>0708</b>
120	4-3/4	15	9/16	35	1-3/8	-	-	16	5/8	6000	B/6/48	<b>B CE120</b>	<b>0215</b>
125	5	20	3/4	32	1-1/4	28	1-1/8	16	5/8	6000	5/40	<b>CE3122</b>	<b>0709</b>
125	5	20	3/4	32	1-1/4	28	1-1/8	16	5/8	6000	B/6/48	<b>B CE3122</b>	<b>0710</b>
150	6	18	3/4	32	1-1/4	38	1-1/2	KIT	mm	6000	B/6/48	<b>B CE4151</b>	<b>0101</b>
150	6	18	3/4	32	1-1/4	38	1-1/2	KIT	mm	6000	5/20	<b>CE4151</b>	<b>0713</b>
150	6	20	3/4	32	1-1/4	38	1-1/2	KIT	mm	6000	5/20	<b>CE4152</b>	<b>0714</b>
150	6	20	3/4	32	1-1/4	38	1-1/2	KIT	mm	6000	B/6/48	<b>B CE4152</b>	<b>0715</b>
150	6	25	1	32	1-1/4	38	1-1/2	KIT	mm	6000	4/16	<b>CE4153</b>	<b>0719</b>
180	7-1/8	22	7/8	47	1-7/8	38	1-1/2	KIT	mm	6000	4/16	<b>CE4183</b>	<b>0716</b>
200	8	22	7/8	47	1-7/8	38	1-1/2	KIT	mm	6000	2	<b>CE4202</b>	<b>0722</b>
200	8	30	1-1/8	47	1-7/8	38	1-1/2	KIT	mm	6000	2	<b>CE4203</b>	<b>0721</b>
225	8-7/8	32	1-1/4	60	2-3/8	38	1-1/2	KIT	mm	6000	1	<b>CE4225</b>	<b>0724</b>
250	10	32	1-1/4	47	1-7/8	38	1-1/2	KIT	mm	6000	2	<b>CE4253</b>	<b>0723</b>

### APPLICAZIONI / APPLICATIONS

Sbavatura, satinatura e lucidatura di superfici di ogni materiale e forma. Sono adatte per lavori meno pesanti e continuativi rispetto alla linea Tech.

Deburring, satin finishing and polishing of any kind of surface and material. Compared to the Tech line, they are recommended for lighter and less continuous applications.

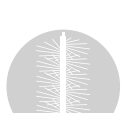

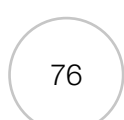
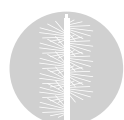

# MOLA / BENCH GRINDER



## > Spazzole circolari / Wheel brushes

U3152



U5202

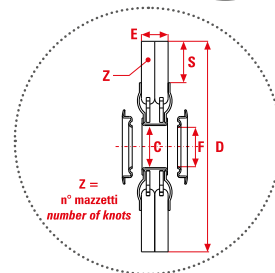

Spazzole circolari in filo d'acciaio a mazzetti ritorti per lavori gravosi ad alte velocità di rotazione.

Twist knots wheel brushes suitable for heavy-duty applications at high rotation speed.

### Circolari a mazzetti ritorti / Twist knot wheel brushes

D		E		S		C		F		Z	MAX RPM		ART	0,50mm	0,80mm
mm	inch	mm	inch	mm	inch	mm	inch	mm	inch					0,020"	0,031"
150	6	18	3/4	30	1-1/8	32	1-1/4	16	5/8	24x2	9000	1/16	U3152	0511	0512
150	6	30	1-1/8	30	1-1/8	32	1-1/4	16	5/8	24x3	9000	1/8	U3153	0513	0514
200	8	30	1-1/8	43	1-3/4	50	2	20	3/4	32x2	9000	1/10	U5202	0524	0525
200	8	40	1-5/8	43	1-3/4	50	2	20	3/4	32x3	9000	1/5	U5203	0526	0527
200	8	30	1-1/8	23	7/8	77	3	25	1	40x2	9000	1	U8202*	2198	
200	8	40	1-5/8	23	7/8	77	3	25	1	40x3	9000	1	U8203*	2199	
250	10	14	9/16	48	1-7/8	77	3	25	1	40	4500	1	U8250	0528	
250	10	30	1-1/8	48	1-7/8	77	3	25	1	40x2	4500	1	U8252	0530	0531
250	10	40	1-5/8	48	1-7/8	77	3	25	1	40x3	4500	1	U8253	0532	0533

\* U8202, U8203 Altissima densità di filamento (+ aggressività + durata) / very high wire density (+ aggressiveness + lifespan).

### Anelli a mazzetti ritorti / Twist knot single section wheel brushes

D		E		S		F		Z	MAX RPM		ART	0,50mm
mm	inch	mm	inch	mm	inch	mm	inch					0,020"
250	10	16	5/8	44	1-3/4	50 + 6ch	2" + 6ch	50	9000	1	U10250	0568
300	12	14	9/16	53	2-1/8	83 + 2ch	3-1/4 + 2ch	64	9000	5	U12300	2153



### APPLICAZIONI / APPLICATIONS

Sbavature e decapaggio meccanico aggressivo.  
Deburring and aggressive mechanical pickling.

# MOLA / BENCH GRINDER

## > Riduzioni / Adapters



Turtlebore 2" +6ch

Riduzioni per spazzole circolari e a tazza in filo ondulato o a mazzetti ritorti. In plastica o acciaio e con sedi chiave.

Adapters for crimped wire or twist knots wheel brushes and cup brushes. Made of plastic or steel, they can have keyways.

### Riduzioni / Adapters

SERIE RANGE	C		F		ART	Ref
	mm	inch	mm	inch		
M14/M10	M14		M10		M10/M14	1059
TAZZE/ULTRA	22.2	7/8	16	5/8	22 RP 16	1055
TAZZE/ULTRA	22.2	7/8	12,7	1/2	22 RP 1/2"*	1060
3000	28	1-1/8	8	5/16	30 RL 8	1017
3000	28	1-1/8	10	3/8	30 RL 10	1018
3000	28	1-1/8	12	1/2	30 RL 12	1019
3000	28	1-1/8	13	1/2	30 RP 13*	1038
3000	28	1-1/8	14	9/16	30 RL 14	1020
3000	28	1-1/8	16	5/8	30 RP 16*	1039
3000	28	1-1/8	18	3/4	30 RL 18	1021
3000	28	1-1/8	20	3/4	30 RL 20	1022
3000	28	1-1/8	22	7/8	30 RL 22	1023
4000	38	1-1/2	13	1/2	40 RP 13*	1042
4000	38	1-1/2	14	9/16	40 RP 14*	1043
4000	38	1-1/2	22	7/8	40 RL 22	1026
4000	38	1-1/2	25.4	1	40 RL 25,4	1015
4000	38	1-1/2	32	1-1/4	40 RL 32	1013
4000	38	1-1/2	multiforo/multibore 25-20-16 mm		RP KIT mm*	1053
4000	38	1-1/2	multiforo/multibore 1"-3/4"-5/8"-1/2"		RP KIT inch*	1054
4000 (Anelli)	40	1-5/8	16	5/8	40 RP 16*	1056
6000	58	2-1/4	16	5/8	60 RL 16	1030
6000	58	2-1/4	20	3/4	60 RL 20	1031
6000	58	2-1/4	25	1	60 RL 25	1032
6000	58	2-1/4	25.4	1	60 RL 25,4	1033
6000	58	2-1/4	30	1-1/8	60 RL 30	1034
6000	58	2-1/4	38	1-1/2	60 RL 38	1014

SERIE RANGE	C		F		ART	Ref
	mm	inch	mm	inch		
U 8-10000	77	3	16	5/8	80 RL 16	1057
U 8-10000	77	3	20	3/4	80 RL 20	1035
U 8-10000	77	3	25	1	80 RL 25	1036
U 8-10000	77	3	30	1-1/8	80 RL 30	1037
U 3000	32	1-1/4	16	5/8	U 30 RP 16*	1040
U 3000	32	1-1/4	22	7/8	U 30 RP 22*	1041
U 3000	32	1-1/4	16	5/8	U 30 RL 16	1024
U 3000	32	1-1/4	20	3/4	U 30 RL 20	1025
U 5000	50	2	20	3/4	U 50 RL 20	1028
U 5000	50	2	28	1-1/8	U 50 RL 28	1029
10000	100	4	25	1	RL100 F25	1058
10000	100	4	70 + 2ch		RL 100 F70	1070
10000	100	4	80+2ch		RL 100 F80	1051
10000	100	4	83+2ch		RL 100 F83	1052
10000	100	4	2"+6ch		RL 100 F2"	1050
12000	120	4-3/4	80+2ch		RL 120 F80	1047
12000	120	4-3/4	83+2ch		RL 120 F83	1046
12000	120	4-3/4	50		RL 120 F50	1049
12000	120	4-3/4	2" + 6ch		RL 120 F2"	1048

### Come scegliere la giusta riduzione / How to choose the correct adapter

Diametro spazzola (D)		Diametro di foro minimo (F)	
Brush diameter (D)		Minimum hole diameter (F)	
mm	inch	mm	inch
50	2	4,6	1/8
75	3	6,5	1/4
100	4	10	3/8
150	6	13	1/2
200	8	16	5/8
250	10	20	3/4
300	12	20	3/4
350	14	32	1-1/4

\* Riduzioni in plastica / Plastic adapters

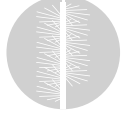



# > Anelli / Single section wheels

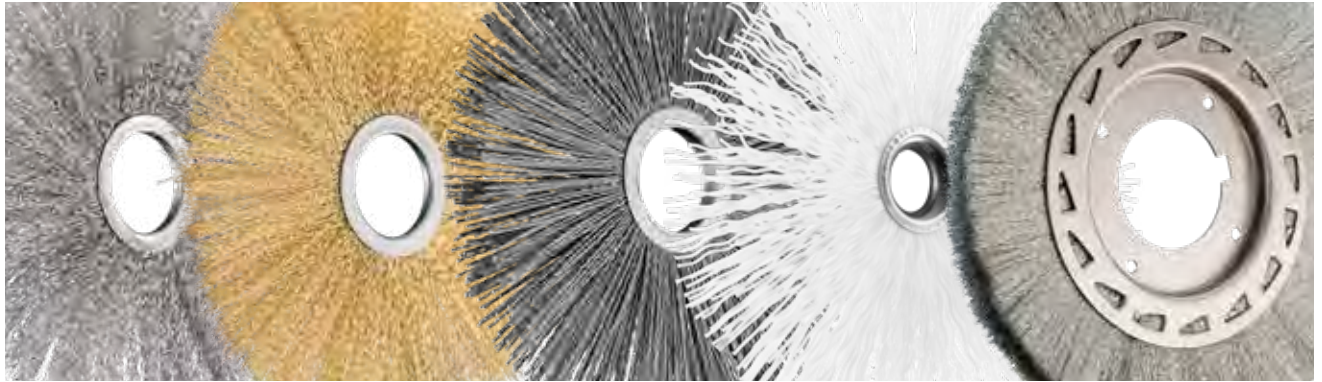

## DISEGNI TECNICI / TECHNICAL DRAWINGS

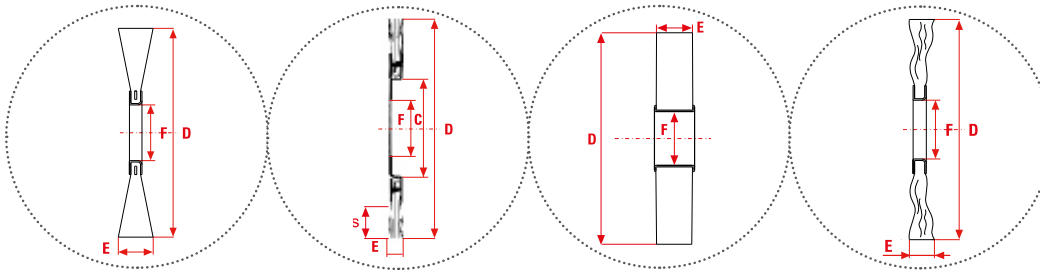

### LEGENDA PACK

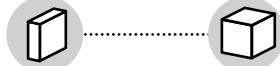

**Single pack**  
e.g. 1/10

Confezione singola con eventuale imballo secondario da 10 pezzi / Single pack with 10-pcs secondary packaging (if any)

**Multipack**  
e.g. 5/40

Confezione multipla da 5 pezzi con eventuale imballo secondario da 40 pezzi / Multiple pack containing 5 pcs with 40-pcs secondary packaging (if any)

### LEGENDA FILO / FILAMENT



**Acciaio / Steel**

**Inox / Stainless Steel**

**Ottone / Brass**

**Cordicella d'acciaio Liz / LIZ Steel Cord**

**Nylon abrasivo / Abrasive Nylon**

Filamenti in Nylon abrasivo:  
O.A. = Ossido di Alluminio  
C.S. = Carburo di Silicio  
Abrasive Nylon filaments:  
O.A. = Aluminium Oxide  
C.S. = Silicon Carbide



**Nylon / Nylon**



**PPL.BO**  
Polipropilene bianco ondulato / White crimped polypropylene

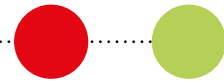

**BESSEMER TAMPICO**  
Filo ondulato sottile a bassa percentuale di carbonio / Fine low carbon crimped wires



**Fibra vegetale / Plant fiber**

## NOTE / NOTES

**Gli articoli con Ref ROSSA sono i più venduti / scelte consigliate**  
**Items marked in RED are the best sellers / recommended choice**

Anelli 60/... +50% densità rispetto agli anelli 40/...  
Single section wheels 60/... +50% density compared to 40/...  
Anelli 80/... +100% densità rispetto agli anelli 40/...  
Single section wheels 80/... +100% density compared to 40/...

**MAGGIORE DENSITÀ = MAGGIORE AGGRESSIVITÀ**  
**HIGHER DENSITY = HIGHER AGGRESSIVENESS**

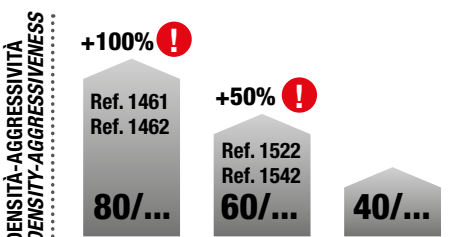

## > Anelli / Single section wheels



CCW3"



CCW2"



CCW2"



CCW2"



CCW1,5"



CCW1"

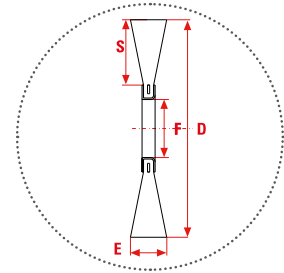

Le circolari copper center CCW hanno profilo sottile, alta densità di filamento e perfetta simmetria costruttiva in modo tale da permettere montaggio singolo o a pacchetto, su gambo o mandrino per centro di lavoro a controllo numerico.

The CCW, copper center wheel brushes, have a thin profile, high filament density and perfect construction symmetry. They are perfect for a single or package assembly, on a shank or on a CNC spindle.

### Circolari Copper Center / Copper Center Wheels Brush

D		E		S		F		MAX RPM		ART	0,20mm	0,35mm	0,15mm	0,35mm
mm	inch	mm	inch	mm	inch	mm	inch				0,008"	0,012"	0,006"	0,014"
38,1	1 1/2	9	3/8	9	3/8	9,52	3/8	20000	2/16	CCW1.5"	5050	5000	5051	5052
50,8	2	10	3/4	12	15/32	12,7	1/2	20000	2/16	CCW2"	5001	5002	5007	5053
63,5	2 1/2	16	5/8	18	45/64	12,7	1/2	20000	2/16	CCW2.5"	5003	5004	5054	5055
76,2	3	18	6/8	25	1	12,7	1/2	20000	2/16	CCW3"	5005	5056	5008	5009
76,2	3	18	45/64	24	1	15,88	5/8	20000	2/16	CCW3"	5006	5057	5058	5059

### Circolari Copper Center in Nylon Abrasivo / Abrasive Copper Center wheel brushes

D		E		S		F		MAX RPM		ART	0,55mm-0,022"	0,90mm-0,037"	0,55mm-0,022"
mm	inch	mm	inch	mm	inch	mm	inch				120gr	180gr	320gr
38,1	1 1/2	8	5/16	6	15/64	12,7	1/2	20000	2/16	CCW1.5"	5060	5061	5020
50,8	2	10	3/4	12	15/32	12,7	1/2	20000	2/16	CCW2"	5021	5062	5022
50,8	2	10	3/4	11	28/64	15,88	5/8	20000	2/16	CCW2"	5063	5023	5024
63,5	2 1/2	12	15/32	18	45/64	12,7	1/2	20000	2/16	CCW2.5"	5025	5064	5026
63,5	2 1/2	12	15/32	17	43/64	15,88	5/8	20000	2/16	CCW2.5"	5027	5065	5028
76,2	3	14	9/16	25	1	12,7	1/2	20000	2/16	CCW3"	5066	5067	5029
101,6	4	16	5/8	24	1	30	1 3/16	6000	2/16	CCW4"	5030	5068	5069

### Circolari Copper Center in Abrasivo Ceramico / Ceramic Abrasive Copper Center wheel brushes

D		E		S		F		MAX RPM		ART	CERAMIX			
mm	inch	mm	inch	mm	inch	mm	inch				1mm-0,040"	0,7mm-0,027"	0,55mm-0,022"	0,55mm-0,022"
											80gr	120gr	220gr	320gr
25,4	1	5	12/64	5	12/64	6,35	1/4	20000	2/16	CCW1"	5070	5010	5071	5072
31,75	1 1/4	6	15/64	8	5/16	6,35	1/4	20000	2/16	CCW1.25"	5073	5011	5074	5075
38,1	1 1/2	8	5/16	6	15/64	12,7	1/2	20000	2/16	CCW1.5"	5076	5012	5077	5013
50,8	2	10	25/64	12	15/32	12,7	1/2	20000	2/16	CCW2"	5014	5015	5216	5017
76,2	3	14	9/16	25	1	12,7	1/2	20000	2/16	CCW3"	5018	5079	5080	5019
101,6	4	16	5/8	24	1	30	1 3/16	6000	2/16	CCW4"	5217	5218	5219	5220

### APPLICAZIONI / APPLICATIONS

Pulizia e sbavatura di spigoli o aree di difficile accesso come piccole aperture, fessure, scanalature lavorate, sbavature fini su strumenti medicali e dentature di ingranaggi.

Cleaning and deburring of edges or areas of difficult access such as small openings, slits. Perfect for fine deburring of medical instruments and gear teeth.

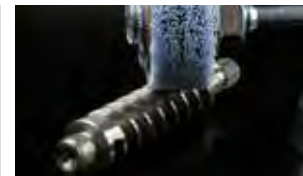
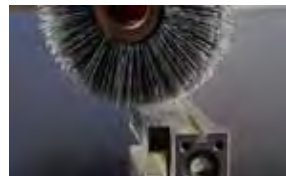



# MOLA / BENCH GRINDER



## > Anelli / Single section wheels

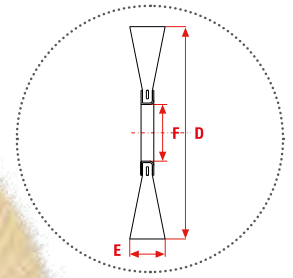
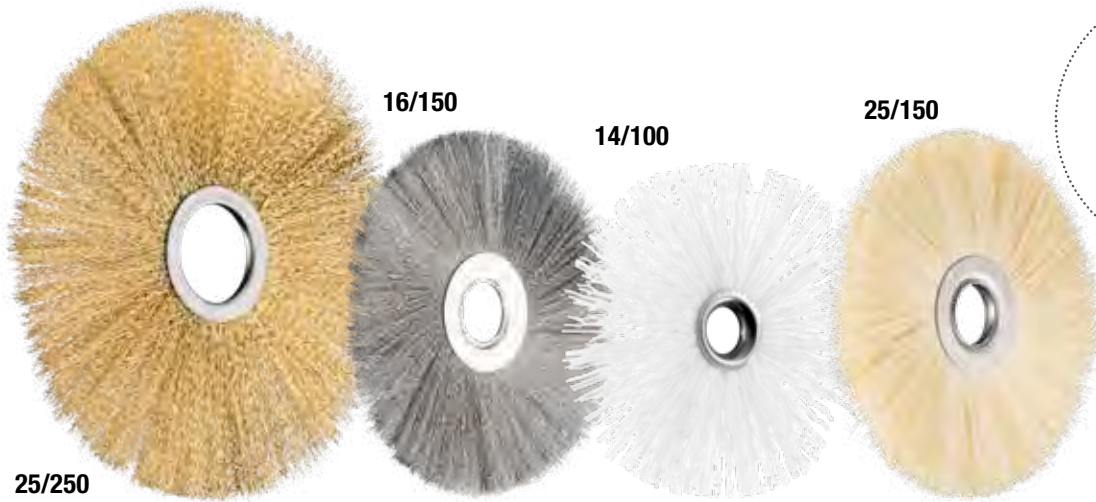

25/250

Anelli/singoli elementi di spazzola disponibili in molteplici materiali e dimensioni.

Single section wheel/single unit brushes available in different materials and sizes.



### Anelli foro 6→25mm - 1/4"→1" / Single section wheels, arbor hole 6→25mm - 1/4"→1"

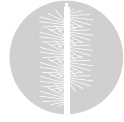

D		E		F		MAX RPM	ART	BESSEMER	0,20mm	0,30mm	0,30mm	0,20mm
mm	inch	mm	inch	mm	inch			0,15mm-0,006"	0,008"	0,012"	0,012"	0,008"
30	1-1/8	5	3/16	6	1/4	12000	24/288					0829
40	1-5/8	5	3/16	10	3/8	18000	10/120					1400
50	2	5	3/16	10	3/8	15000	10/120					1401
60	2-3/8	5	3/16	10	3/8	15000	10/120					1402
100	4	5	3/16	16	5/8	6000	10/80	1404				1403
100	4	8	5/16	25	1	6000	10/80	25/100	1409			1408
120	4-3/4	5	5/16	16	5/8	6000	10/80	16/120	1406			
120	4-3/4	8	5/16	25	1	6000	10/80	25/120				1410
150	6	5	5/16	16	5/8	6000	10/40	16/150	1407			
150	6	8	5/16	25	1	6000	10/40	25/150	1413			1412
200	8	8	5/16	25	1	4500	10	25/200	1421	1415	1416	0907 1418
250	10	8	5/16	25	1	3600	10	25/250	1423			1422



D		E		F		MAX RPM	ART	Nylon	PPL B.O.	TAMPICO
mm	inch	mm	inch	mm	inch			0,80mm-0,031"	0,35mm-0,014"	0,30mm-0,012"
80	3-1/8	5	3/16	14	9/16	6000	6/72	14/80	1999	
100	4	5	3/16	14	9/16	6000	6/48	14/100	2000	
120	4-3/4	5	5/16	14	9/16	6000	6/48	14/120	2001	
150	6	8	5/16	25	1	6000	10/40	25/150		1414
200	8	8	5/16	25	1	4500	10	25/200		1420
250	10	8	5/16	25	1	4500	10	25/250		1424

### APPLICAZIONI / APPLICATIONS

Sbavatura fine, satinatura e lucidatura di superfici di ogni materiale e forma.  
Fine deburring, satin finishing and polishing of surfaces of any material and shape.

**> Anelli / Single section wheels**

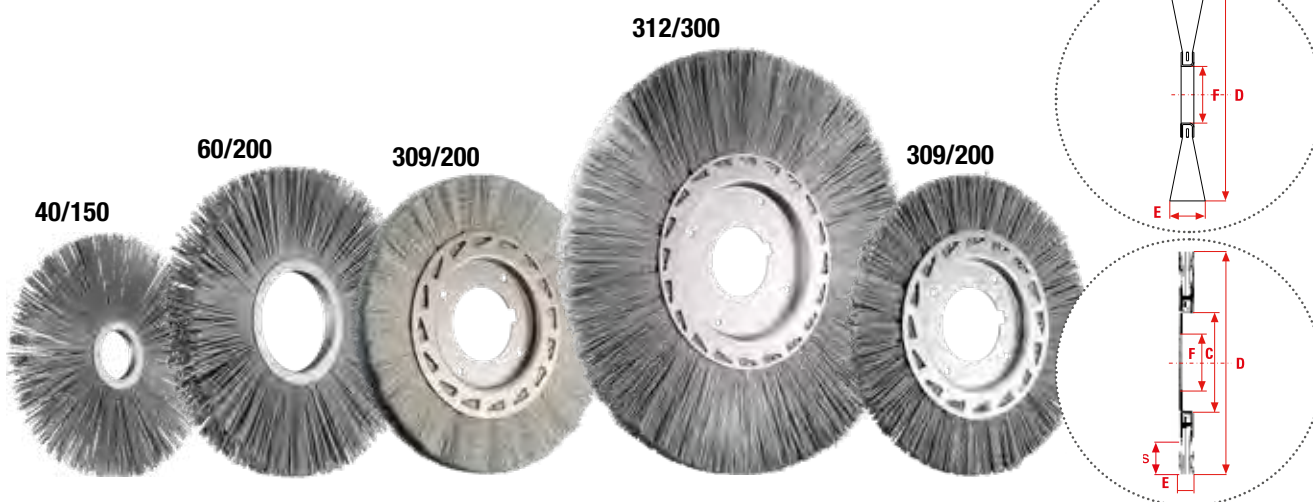
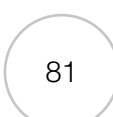

Anelli/singoli elementi di spazzola disponibili in molteplici materiali e dimensioni.

Single section wheel/single unit brushes available in different materials and sizes

**Anelli foro 40→60mm - 1-5/8"→2-3/8" / Single section wheels, arbor hole 40→60mm - 1-5/8"→2-3/8"**

D		E		F		MAX RPM	ART	0,35mm	0,50mm	0,20mm	0,30mm	0,25mm
mm	inch	mm	inch	mm	inch			0,014"	0,020"	0,008"	0,012"	0,010"
150	6	9	3/8	40-16*	1-5/8 - 5/8*	6000	5	<b>40/150</b>	<b>1426</b>		<b>0918</b>	<b>1430</b>
200	8	9	3/8	40-16*	1-5/8 - 5/8*	6000	5	<b>40/200</b>	<b>1433</b>	<b>1434</b>	<b>0908</b>	<b>1437</b>
200	8	9	3/8	60	2-3/8	6000	5	<b>60/200</b>	<b>1466</b>	<b>1467</b>		<b>1468</b>

D		E		F		MAX RPM	ART	1,40mm-0,055" 0,55mm-0,022" 0,90mm-0,037"		
mm	inch	mm	inch	mm	inch			C.S. gr 80	C.S. 120 gr	C.S. 180 gr
100	4	5	3/16	16	5/8	6000	1	<b>16/100</b>		<b>1405</b>
150	6	9	3/4	40 - 16	1-5/8 - 5/8	6000	1	<b>40/150</b>		<b>1431</b>
200	8	9	3/4	40 - 16	1-5/8 - 5/8	6000	1	<b>40/200</b>		<b>1438</b>
200	8	9	3/4	60	2-3/8	6000	1	<b>60/200</b>	<b>1519</b>	<b>1521</b>
200	8	9	3/4	80	3-1/8	6000	1	<b>80/200</b>		<b>1461</b>
250	10	9	3/4	40 - 16	1-5/8 - 5/8	6000	1	<b>40/250</b>		<b>1439</b>
250	10	9	3/4	60	2-3/8	6000	1	<b>60/250</b>		<b>1542</b>
250	10	9	3/4	80	3-1/8	6000	1	<b>80/250</b>		<b>1462</b>

**Anelli serie 300 / 300 series single section wheel brushes**

D		E		C		F		MAX RPM	ART	0,35mm	
mm	inch	mm	inch	mm	inch	mm	inch			0,014"	
200	8	9	3/8	86	3-3/8	50,8	2	4500	1	<b>309/200</b>	<b>1440</b>
250	10	9	3/8	86	3-3/8	50,8	2	3600	1	<b>309/250</b>	<b>1447</b>
300	12	11	7/16	106	4-1/8	50,8	2	3000	1	<b>312/300</b>	<b>1448</b>
350	14	15	5/8	156	6-1/8	50,8	2	2500	1	<b>316/350</b>	<b>1455</b>
400	16	15	5/8	156	6-1/8	50,8	2	2000	1	<b>316/400</b>	<b>1456</b>

\* Per foro 16mm - 5/8", aggiungere Ref 1056 / For 16mm - 5/8" arbor hole, add Ref 1056.

**Nylon abrasivo / Abrasive Nylon**  
 Attenzione alle velocità di rotazione consigliate per ogni applicazione: vedi tabella 2 pag. 21.  
 Pay attention to the recommended speed for each application: see table 2 page 21.

D		E		C		F		MAX RPM	ART	1mm-0,039"	0,60mm-0,024"	0,60mm-0,024"	0,50mm-0,020"	
mm	inch	mm	inch	mm	inch	mm	inch			C.S. 80 gr	C.S. 120 gr	C.S. 320 gr	O.A. 500 gr	
200	8	9	3/8	86	3-3/8	50,8	2	4500	1	<b>309/200</b>	<b>1441</b>	<b>1442</b>	<b>1445</b>	<b>1446</b>
300	12	11	7/16	106	4-1/8	50,8	2	3000	1	<b>312/300</b>	<b>1449</b>	<b>1450</b>	<b>1453</b>	<b>1454</b>

**APPLICAZIONI / APPLICATIONS**

Sbavatura leggera, satinatura e lucidatura di superfici di ogni tipo. Gli anelli in Nylon abrasivo sono indicati anche per decappare e rusticare.  
 Deburring, satin finishing and polishing of surfaces of any kind. Abrasive Nylon single section wheels are also suited for pickling and wood aging.



## MOLA / BENCH GRINDER

### > Spazzole circolari / Wheel brushes

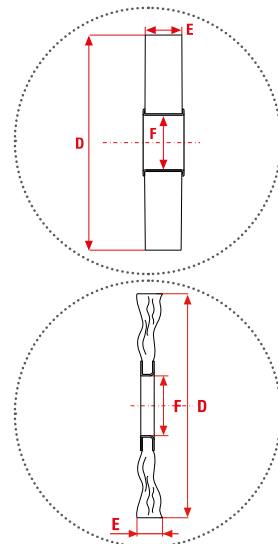

**RF** Spugna abrasiva.

**RC** Lamelle di tela e spugna abrasiva.

**SP** Circolari in panno di media morbidezza per applicazioni su ogni superficie.

**RF** Non-woven abrasive.

**RC** Combinations of non-woven and abrasive flaps.

**SP** Wheel Brushes made of medium soft cloth.

### Ruote di finitura / Finishing wheels

D		E		F		MAX RPM	2	ART	Grana/Grit A 150 gr	Flap grana fine / Fine grained flap
mm	inch	mm	inch	mm	inch					
150	6	25	1	32*	1-1/4	3200	10	<b>RF150 - RC150</b>	<b>0422</b>	<b>0423</b>
175	7	45	1-3/4	50**	2	3200	3	<b>RF175 - RC175</b>	<b>0424</b>	<b>0425</b>
200	8	50	2	76***	3	3200	3	<b>RF200 - RC200</b>	<b>0428</b>	<b>0429</b>

**RC** Vedi adattatori U3000 (\*), U5000 (\*\*), U8000 (\*\*\*) / See adapters U3000 (\*), U5000 (\*\*), U8000 (\*\*\*)

### Circolari in panno / Cloth brushes

D		E		F		MAX RPM	Densità Density	2	ART	Ref
mm	inch	mm	inch	mm	inch					
150	6	12	1/2	16 - 20	5/8 - 3/4	4000	160	10	<b>SP150</b>	<b>0405</b>
150	6	12	1/2	16 - 20	5/8 - 3/4	4000	160	B/6/48	<b>B SP150</b>	<b>0404</b>
200	8	12	1/2	20	3/4	4000	230	10	<b>SP200</b>	<b>0406</b>
250	10	12	1/2	25	1	4000	300	10	<b>SP250</b>	<b>0407</b>

### Pasta abrasiva per circolari in panno / Abrasive paste for cloth brushes

Descrizione / Description	2	ART	Ref
Pasta abrasiva per la brillantatura di metalli Abrasive paste for metal bright finishing	1	<b>DIALUX BIANCA / WHITE</b>	<b>0408</b>
Pasta abrasiva per la superfinitura di metalli Abrasive paste for metal fine finishing	1	<b>DIALUX BLU / BLUE</b>	<b>0409</b>

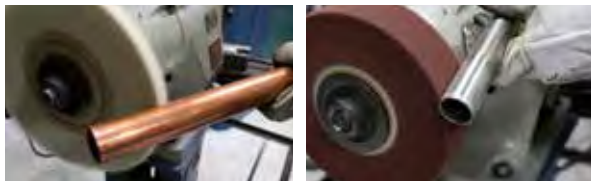

### APPLICAZIONI / APPLICATIONS

**RF, RC** Finitura e satinatura, rimozione di ossido da circuiti stampati, opacizzazione di superfici plastiche, finitura omogenea di alluminio, ottone e inox.

**SP** Pulizia e lucidatura di superfici ferrose e non ferrose con le paste abrasive Dialux.

**RF, RC** Finishing and satin finishing, oxide removal from printed circuit boards, de-glossing of plastic surfaces, uniform finishing on aluminum, brass and stainless steel.

**SP** Cleaning and polishing of ferrous and non-ferrous surfaces using abrasive paste Dialux.



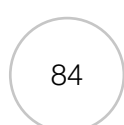
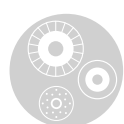
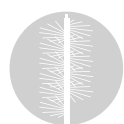

**LEVIGATRICE  
WHEEL SANDER**



**SPAZZOLE A RULLO PER LEVIGATRICI / BRUSHES FOR WHEEL SANDERS**

p. 85



> **Rulli per levigatrice Makita**  
*Brushes for Makita Wheel sander*

p. 86



> **Rulli per levigatrici Festool**  
*Brushes for Festool wheel sander*

p. 87



> **Rulli per spazzolatrice Flex**  
*Brushes for Flex Brushing Machines*

p. 88



> **Rulli, dischi e tazze per levigatrici**  
*Staple set rollers, disc and cup brushes for sanders*

p. 89

# > Spazzole a rullo per levigatrici / Brushes for wheel sanders



GUARDA IL VIDEO  
WATCH THE VIDEO



[www.sitbrush.tv/w1](http://www.sitbrush.tv/w1)

## DISEGNI TECNICI / TECHNICAL DRAWINGS

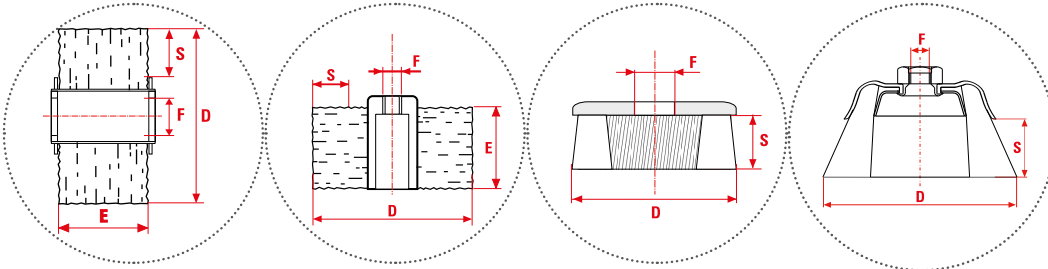

### LEGENDA PACK



Single pack  
e.g. 1/6

Confezione singola con eventuale imballo  
secondario da 6 pezzi / 6-piece single  
package possibly with secondary packaging

### NOTE / NOTES

I rulli per levigatrici sono ideali per rimuovere graffi o vernici da muro e legno.  
Wheel brushes for sanders are ideal to remove graffiti or paint from walls and wood.



GUARDA IL VIDEO  
WATCH THE VIDEO



[sitbrush.tv/wall1](http://sitbrush.tv/wall1)

### LEGENDA FILO / FILAMENT



Acciaio /  
Steel

Inox /  
Stainless  
Steel

Cordicella  
d'acciaio  
Liz / LIZ  
Steel Cord

Nylon abrasivo  
/ Abrasive  
Nylon

TAMPICO  
Fibra vegetale /  
Plant fiber

Filamenti in Nylon abrasivo:  
O.A. = Ossido di Alluminio  
C.S. = Carburo di Silicio  
Abrasive Nylon filaments:  
O.A. = Aluminium Oxide  
C.S. = Silicon Carbide

### Nylon abrasivo / Abrasive Nylon

Attenzione alle velocità di rotazione consigliate per ogni applicazione! Per plastica e legno la velocità di lavoro ideale è 15-20m/s - 2900-3900ft/min. Per superfici metalliche la velocità di lavoro ideale è 30m/s - 5800ft/min. (Vedi tabella 2 pag. 21).

Pay attention to the recommended speed for each application! The ideal speed for plastic and wood is 15-20m/s - 2900-3900ft/min. The ideal speed for metal surfaces is 30m/s - 5800ft/min. (See table 2 page 21).

Gli articoli con Ref ROSSA sono i più venduti / scelte consigliate  
Items marked in RED are the best sellers / recommended choice



# LEVIGATRICE / WHEEL SANDER

TECH

## > Rulli per levigatrice Makita / Brushes for Makita wheel sander

Ref 0786

Ref 0781

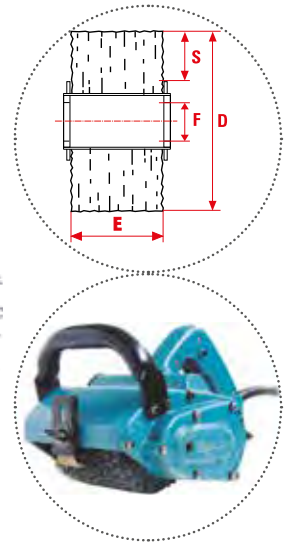

Spazzole a rullo per levigatrici e macchine satinatrici di tipo Makita 9741.

Wheel brushes for Makita 9741 wheel sander and satin finishing machines.

### Rulli ad alta densità / High density wheels

D		S		E		F		MAX RPM	2	ART	1,50mm-0,059"			0,30mm	0,25mm
mm	inch	mm	inch	mm	inch	mm	inch				46 gr	60 gr	80 gr	0,012"	0,010"
100	4	18	3/4	115	4-1/2	12,8+2ch	1/2+2ch	3500	1/6	RSM				0781	0775
100	4	21	7/8	115	4-1/2	12,8+2ch	1/2+2ch	3500	1/6	RSM	0777	0776	0786		

### Rulli punzonati / Staple set wheels

100	4	21	7/8	115	4-1/2	12,8+2ch	1/2+2ch	3500	1/6	RSM	0773	0772	0771		
-----	---	----	-----	-----	-------	----------	---------	------	-----	-----	------	------	------	--	--

Ref 0772



### APPLICAZIONI / APPLICATIONS

Adatte a satinare, levigare, rusticare ferro, pietra, marmo e legno.  
Suitable for satin finishing, sanding, texturing and structuring on iron, stone, marble and wood.



## > Rulli per levigatrici Festool / Brushes for Festool wheel sanders

Ref 1386

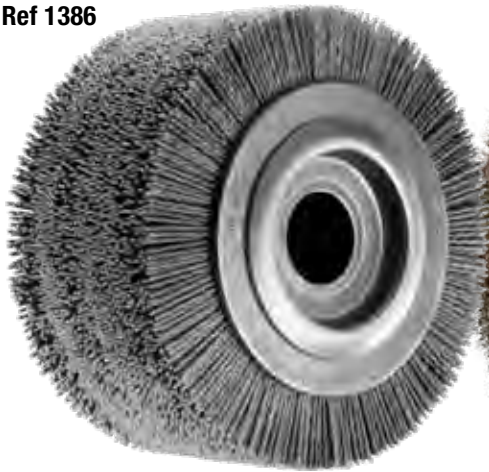

Ref 1387

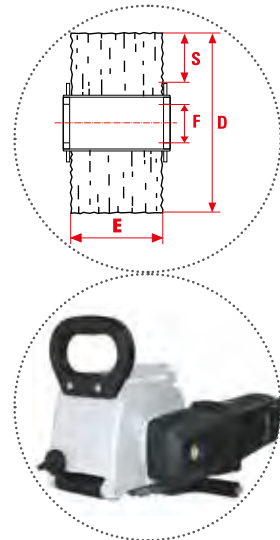

Spazzole a rullo per spazzolatrici e macchine satinatrici di tipo Festool (Rustofix).

Roller brushes for Festool brushing machines and satin finishing machines (Rustofix).

### Spazzole a rullo / Wheel brushes

D		S		E		F		MAX RPM	ART	1,4mm-0,055"		0,30mm	
mm	inch	mm	inch	mm	inch	mm	inch			80 gr	0,012"		
150	6	20	3/4	85	3-3/8	16 - 30	5/8 - 1-1/8	6000	1	<b>RSF</b>	<b>1386</b>	<b>1387</b>	



GUARDA IL VIDEO  
WATCH THE VIDEO



GUARDA IL VIDEO  
WATCH THE VIDEO



### APPLICAZIONI / APPLICATIONS

Adatte a diverse lavorazioni (satinare, levigare, rusticare) su ferro, pietra, marmo e legno. I rulli in spugna abrasiva sono adatti per la finitura e la satinatura di superfici piane di alluminio, ottone e acciaio Inox.

Suitable for different processes (satin finishing, sanding, wood-aging, wood-texturing, rusticize) on iron, stone, marble and wood. Non-woven abrasive rollers are suitable for finishing and satin finishing aluminum, brass and stainless steel flat surfaces.





# LEVIGATRICE / WHEEL SANDER



## > Rulli per spazzolatrice Flex / Brushes for Flex Brushing Machines

Ref 1371

Ref 1359

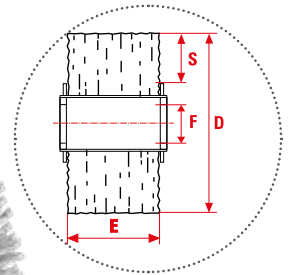

Spazzole a rullo per spazzolatrici e macchine satinatrici di tipo Flex, disponibili in diversi materiali. Montabili su smerigliatrici angolari o trapani tramite gli appositi alberi adattatori.

Wheel brushes for Flex sanders and finishing machines. They can be mounted on angle grinders or drills using proper adapters.

### Spazzole a rullo ad alta densità / High density wheel brushes

D		S		E		F		MAX RPM		ART	1,6mm-0,063"	1,5mm-0,059"	1,4mm-0,055"
mm	inch	mm	inch	mm	inch	mm	inch				46 gr	60 gr	80 gr
100	4	20	3/4	70	2-3/4	19+4ch	3/4+4ch	5700	1/6	RSF	1369	1388	1370
100	4	20	3/4	100	4	19+4ch	3/4+4ch	5700	1/6	RSF	1360	1389	1359

### Spazzole a rullo ad alta densità / High density wheel brushes

D		S		E		F		MAX RPM		ART	0,20mm	0,30mm	0,20mm
mm	inch	mm	inch	mm	inch	mm	inch				0,008"	0,012"	0,008"
100	4	20	3/4	70	2-3/4	19+4ch	3/4+4ch	5700	1/6	RSF	1371	1368	1372
100	4	20	3/4	100	4	19+4ch	3/4+4ch	5700	1/6	RSF	1361	1362	1363

### Rulli punzonati / Staple set rollers NEW

D		S		E		F		MAX RPM		ART	1,5mm-0,059"		0,30mm	
mm	inch	mm	inch	mm	inch	mm	inch				46gr	60gr	80gr	0,012"
110	4-3/8	20	3/4	100	4	19+2ch	3/4+2ch	5700	1/6	RSFP	1374	1375	1376	1377



### Rulli di finitura / Finishing wheels

D		S		E		F		MAX RPM		ART	A medium	A fine	A extra fine	A 80
mm	inch	mm	inch	mm	inch	mm	inch				0782	0783	0784	0787*
100	4	25	1	100	4	19+4ch	3/4+4ch	5700	1/6	RSF				



\* Ref 0787 Spugna abrasiva combinata con lamelle di tela abrasiva / Combinations of non-woven and abrasive flaps.

### Adattatori / Adapters

Descrizione / Description		Ref
Albero adattatore M14 per smerigliatrice M14 adapter shaft for grinder	1	0778
Albero adattatore 5/8 per smerigliatrice 5/8 adapter shaft for grinder	1	0798
Albero adattatore Ø 10mm per trapano Ø 25/64" adapter shaft for drill	1	0779
Distanziatore 30mm per rullo E = 70mm Spacer 1-3/16" for roller E = 2-3/4"	1	1373



[sitbrush.tv/adapt1](http://sitbrush.tv/adapt1)

[sitbrush.tv/adapt2](http://sitbrush.tv/adapt2)



## > Rulli e dischi per levigatrici / Staple set rollers and disc brushes for sanders

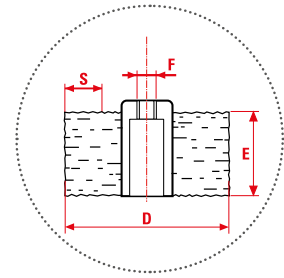

**RPA** Rulli Punzonati in Nylon abrasivo in diverse grane e diametri di filo.

**RPA** Staple set rollers made of abrasive Nylon with different grits and wire diameter.

**TFP** Spazzole punzonate a tazza in Nylon Abrasivo di diversa grana (dalla 46 alla 320).

**TFP** Staple set disc brushes made of Abrasive Nylon with different grits (from 46 to 320).

### Rulli punzonati in Nylon abrasivo / Abrasive Nylon staple set wheels

D		S		E		F	MAX RPM	ART	1,6mm	1,5mm	1,4mm	1,1mm
mm	inch	mm	inch	mm	inch				C.S. 46gr	C.S. 60gr	C.S. 80gr	C.S. 120gr
140	5-1/2	30	1-3/16	50	2	M14	1200	1	<b>3240</b>	<b>3241</b>	<b>3242</b>	<b>3243</b>
140	5-1/2	30	1-3/16	100	4	M14	1200	1	<b>3244</b>	<b>3245</b>	<b>3246</b>	<b>3247</b>



Ref 3264



Ref 3261

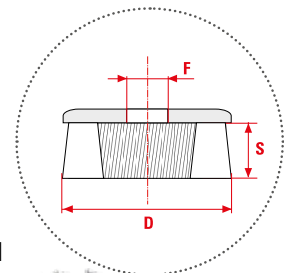

### Dischi in Nylon abrasivo / Abrasive Nylon disc brushes

D		S		F	MAX RPM	ART	1,6mm	1,5mm	1,4mm	1mm	1,6mm
mm	inch	mm	inch				C.S. 46gr	C.S. 60gr	C.S. 80gr	C.S. 180gr	C.S. 320gr
115	4-9/16	25	1	M14	3500	1	<b>3260</b>		<b>3261</b>	<b>3262</b>	<b>3263</b>
130	5-1/8	50	2	M14	3500	1	<b>3264</b>	<b>3265</b>			
150	6	50	2	M14	3500	1	<b>T150 HD</b>	<b>0182</b>			

### APPLICAZIONI / APPLICATIONS

**RPA** Ideali per la lavorazione del legno, del ferro, della pietra, del marmo, e per ogni tipologia di superficie, anche irregolare.

**TFP** Ideali per lavori frontali su superfici piane di ferro, pietra, marmo e legno.

**RPA** Ideal for wood, iron, stone and marble processing on regular and irregular surfaces.

**TFP** Ideal for frontal jobs on steel, stone, marble and wood flat surfaces.



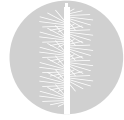

**SPAZZOLE  
A MANO  
HAND BRUSHES**



**SPAZZOLE A MANO / HAND BRUSHES**

p. 91



> **Spid**

p. 92



> **Dorso legno / Staped wood**

p. 94



> **Varie / Various**

p. 95



> **Slim**

p. 95



# > Spid



GUARDA IL VIDEO  
WATCH THE VIDEO



[www.sitbrush.tv/h1](http://www.sitbrush.tv/h1)

## DISEGNI TECNICI / TECHNICAL DRAWINGS

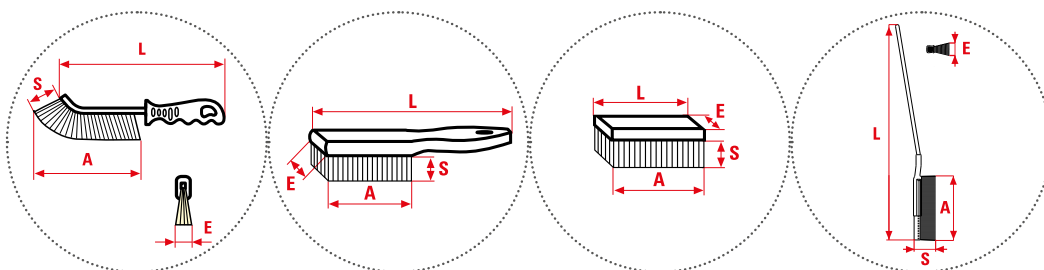

### LEGENDA PACK



**Blister e.g. B/12/96**

Blister singolo in scatole da 12 pezzi con eventuale imballo secondario da 96 pezzi / Single blister pack in boxes containing 12 pcs with 96-pcs secondary packaging (if any)

**Box da 24 pezzi / Box of 24 pieces**

**8 box da 24 pezzi / 8 boxes of 24 pieces**

### LEGENDA FILO / FILAMENT



**Acciaio / Steel**

**Acciaio ottonato / Brass Plated Steel**

**Inox / Stainless Steel**

**Ottone / Brass**

**Nylon**

**PVC piumato / Soft PVC**

## NOTE / NOTES

Gli articoli con Ref ROSSA sono i più venduti / scelte consigliate  
Items marked in RED are the best sellers / recommended choice

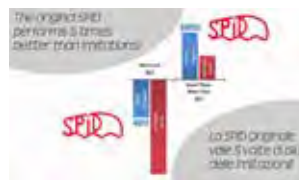

GUARDA IL VIDEO  
WATCH THE VIDEO

[sitbrush.tv/htest](http://sitbrush.tv/htest)



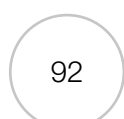
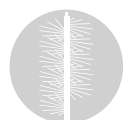

# SPAZZOLE A MANO / HAND BRUSHES



## > Spid

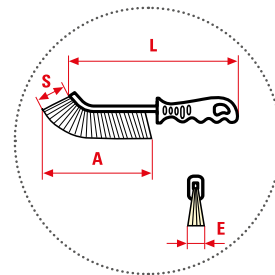

**Spid acciaio / steel**

**Spid inox / S/steel**

**Spid ottone / brass**

**Spid Nylon**

**Spid PVC**

La Spid è la spazzola manuale universale, pratica, maneggevole, resistente ideata e brevettata da SIT Tecnospazzole oltre 50 anni fa. La superficie ristretta, la particolare curvatura ed il manico ergonomico le conferiscono una maneggevolezza unica.

*Spid is the universal hand brush: practical, user friendly and resistant, designed and patented by SIT Tecnospazzole over 50 years ago. The narrow surface, the unique bending and the ergonomic handle make it unique and easy to use.*

### Spid

L		A		S		E		1 2	ART	0,30mm	0,30mm	0,30mm	Nylon rigido / hard	PVC piumato / soft
mm	inch	mm	inch	mm	inch	mm	inch			0,012"	0,012"	0,012"	0013*	0014*
245	9-5/8	135	5-5/16	28	1-1/8	15	9/16	1/8	<b>SPID BOX</b>	<b>0010</b>	<b>0011</b>	<b>0012</b>	<b>0013*</b>	<b>0014*</b>
245	9-5/8	135	5-5/16	28	1-1/8	15	9/16	B/12/96	<b>SPID blister</b>	<b>0005</b>	<b>0006</b>	<b>0007</b>	<b>0008*</b>	

\* Ref 0013, 0008: A= 140mm - 5-1/2", S= 30mm - 1-1/4"; Ref 0014: A= 160mm - 6-1/4", S= 50mm - 2"

**24** **Ogni SPID BOX contiene 24 spazzole SPID / Each SPID BOX contains 24 SPID brushes**

CONTENUTO / Contents	1 2	ART	Ref
7 SPID Inox (Ref 0011) + 7 SPID Ottone / Brass (Ref 0012) + 7 SPID Nylon (Ref 0013)	1/8	<b>SPID Trio</b>	<b>0017</b>

**Ref 0010:**  
minimo d'ordine preferibile di 8 box (cartone completo da 192 pezzi) o multipli di 8 / minimum order quantity 8 boxes (192 pieces in total) or multiples of 8.



#### SPID BOX BARCODE

Ref 0010 EAN 8006581744854  
Ref 0011 EAN 8006581082307  
Ref 0012 EAN 8006581082314

Ref 0013 EAN 8006581082321  
Ref 0014 EAN 8006581082338  
Ref 0015 EAN 8006581744861  
Ref 0016 EAN 8006581744878



**GUARDA IL VIDEO  
WATCH THE VIDEO**

[sitbrush.tv/h1](http://sitbrush.tv/h1)



# SPAZZOLE A MANO / HAND BRUSHES



## > Spid

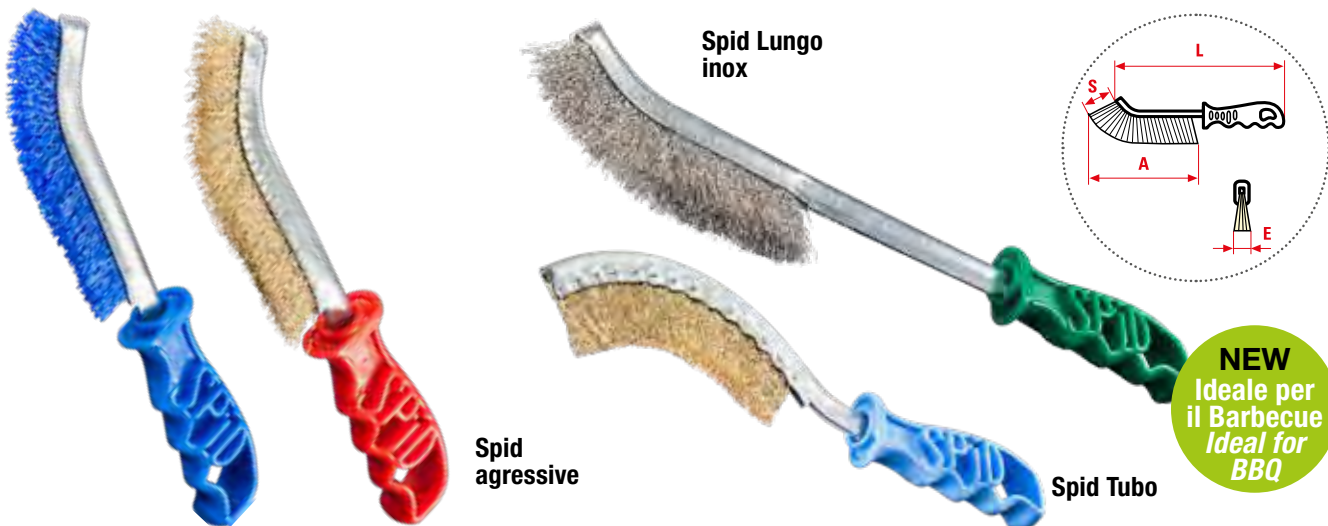

**Aggressivo** Il filamento più corto risulta più rigido e consistente. Ideale dove occorre una precisione maggiore della superficie da spazzolare.

**Lungo / Tubo** Forma sagomata o manico lungo permettono di adattarsi ancora meglio alla superficie di lavoro e all'applicazione specifica. (La Spid a manico lungo permette di pulire superfici ad alta temperatura tenendo le mani al sicuro).

**Aggressivo** The shorter filament is stiffer and stronger. Ideal if you need higher precision in surface brushing.

**Long handled / tube** The contoured shape and the long handle allow the brush to fit even better the working surface and the specific applications. (Long handled Spid allows to clean high temperature surfaces keeping your hands safe).

### Spid aggressivo / Spid aggressive

L		A		S		E		2	ART	0,30mm 0,012"	Nylon rigido / hard
mm	inch	mm	inch	mm	inch	mm	inch				
245	9-5/8	135	5-1/4	18	3/4	10	3/8	8	SPID Box Aggressive	0030	0031

### Spid Lungo e Tubo Spid / Long Spid and Tube Spid

L		A		S		E		2	ART	0,30mm 0,012"	0,30mm 0,012"
mm	inch	mm	inch	mm	inch	mm	inch				
370	14-5/8	135	5-1/4	28	1-1/8	15	9/16	1/8	SPID Box lungo	0015	0023
290	11-3/8	135	5-1/4	28	1-1/8	15	9/16	1/8	SPID Box tubo	0016	



USER FRIENDLY  
ENVIRONMENTALLY FRIENDLY  
ENERGY SAVING



24  
pz/pcs.

Ogni SPID BOX contiene 24  
spazzole SPID / Each SPID BOX  
contains 24 SPID brushes

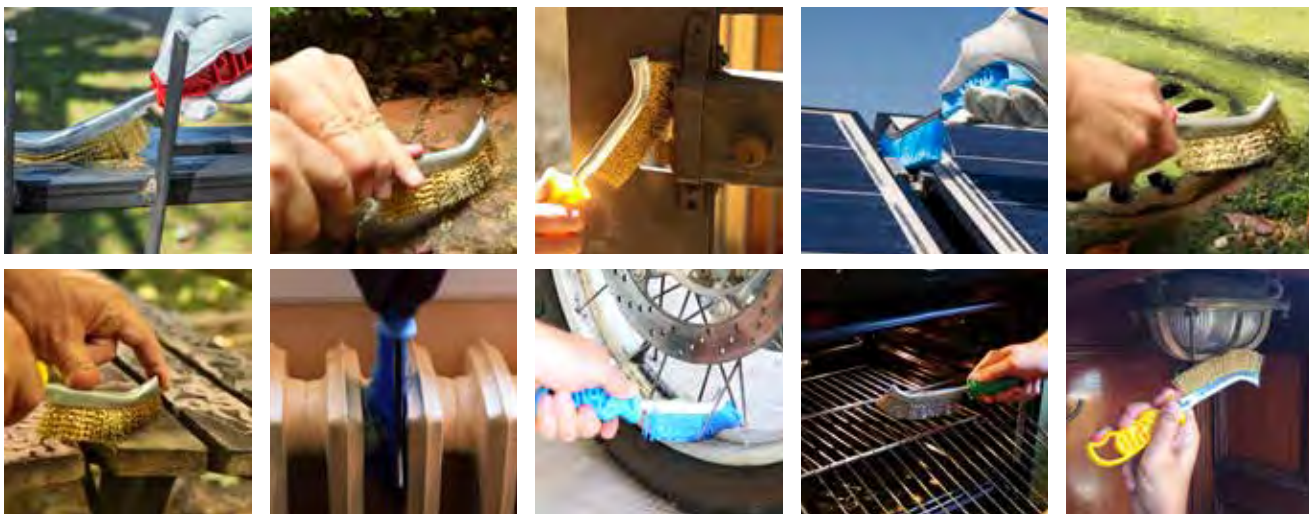

### APPLICAZIONI / APPLICATIONS

Rimuovere ruggine, vernice e sporco da qualsiasi tipo di superficie, pulire il grill, scrostare cancelli, fare manutenzione a bici e moto. Ha anche applicazioni industriali!

Remove rust, paint and dirt from any kind of surface, clean the grill (BBQ), scrape off gates, maintenance of bikes and motorbikes. It also has industrial applications!





# SPAZZOLE A MANO / HAND BRUSHES

## > Dorso legno / Wooden body

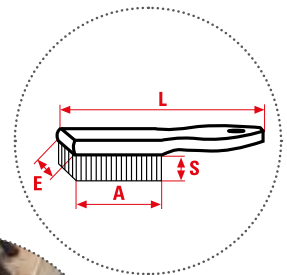

593 PUNTA

Spazzole a mano con filamenti metallici e corpo in legno.  
**593 PUNTA** spazzola convergente.

Hand brushes with metallic wires and wooden body.  
**593 PUNTA** rivet brush

## Spazzole punzonate con manico / Staple set hand brushes with handle

L		A		S		E		Ranghi Rows	ART	0,35mm	0,35mm	0,35mm	
mm	inch	mm	inch	mm	inch	mm	inch			0,014"	0,014"	0,014"	
290	11-3/8	135	5-1/4	25	1	27	1	3	12	<b>593</b>	<b>1800</b>	<b>1823</b>	<b>1840</b>
290	11-3/8	135	5-1/4	25	1	35	1-3/8	3	12	<b>593 PUNTA</b>	<b>1972</b>		
290	11-3/8	135	5-1/4	25	1	32	1-1/4	4	12	<b>594</b>	<b>1801</b>	<b>1781</b>	<b>1877</b>
290	11-3/8	135	5-1/4	25	1	37	1-1/2	5	12	<b>595</b>	<b>1802</b>		
290	11-3/8	135	5-1/4	25	1	42	1-5/8	6	12	<b>596</b>	<b>1803</b>		

Acciaio liscio / Straight steel  
Acciaio Inox ondulato / Crimped S-steel  
Ottone Ondulato / Crimped brass

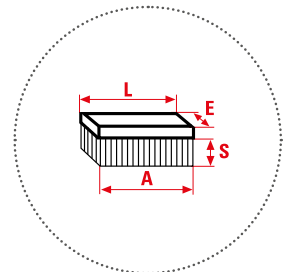

Le spazzole con dorso legno sono marcate con Logo, Referenza e Barcode  
Wooden brushes are marked with Logo, Reference and Barcode



## Spazzole punzonate senza manico / Staple set hand brushes without handle

L		A		S		E		Ranghi Rows	ART	0,35mm	
mm	inch	mm	inch	mm	inch	mm	inch			0,014"	
185	7-1/4	175	7	30	1-1/8	55	2-1/8	6	24	<b>1779</b>	<b>1807</b>
200	8	160	6-1/4	35	1-3/8	55	2-1/8	5	24	<b>5295 violino</b>	<b>1805</b>

[www.sitbrush.tv/htest2](http://www.sitbrush.tv/htest2)

### APPLICAZIONI / APPLICATIONS

Rimuovere la ruggine da superfici piane, pulire saldature, operazioni di raschiatura.  
Rust removal from flat surfaces, weld cleaning, scraping operations.



# SPAZZOLE A MANO / HAND BRUSHES

## > Varie / Various

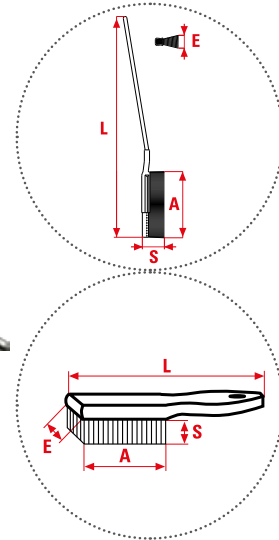
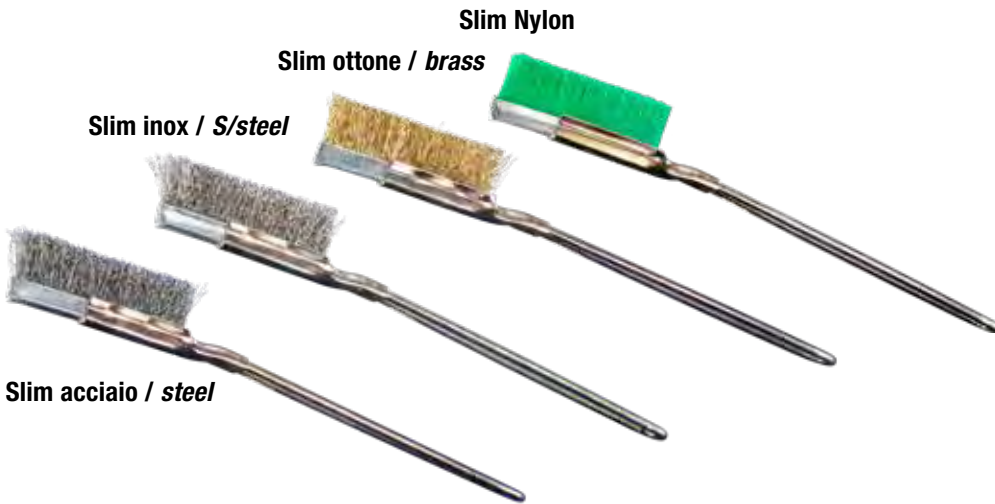

Spazzole a mano con filamenti metallici e corpo in legno o in plastica.

**SLIM** Spazzole di ridotte dimensioni per una migliore spazzolatura manuale di superfici ridotte e con piccole fessure, dove risulta impossibile intervenire con spazzole a mano tradizionali.

Hand brushes with metallic wires and wooden or plastic body. **SLIM** Small hand brushes ideal for limited areas and surfaces with tiny cracks, where it would be impossible to use traditional hand brushes.

### Slim

L		A		S		E		Ranghi Rows	ART	Filamenti / Wires			Materiale / Material
mm	inch	mm	inch	mm	inch	mm	inch			0,20mm	0,20mm	0,20mm	
220	8-3/4	65	2-1/2	15	9/16	6	1/4	1	SLIM	1790	1791	1792	Nylon

Descrizione / Description	Box	ART	Ref
Slim Acciaio 0,20mm + Slim ottone 0,20mm 0,008" Steel Slim + 0,008" Brass Slim	B/12/96	SLIM DUO	0026
Slim Acciaio Inox 0,20mm + Slim Nylon 0,008" Stainless steel Slim + Nylon Slim	B/12/96	SLIM DUO	0027

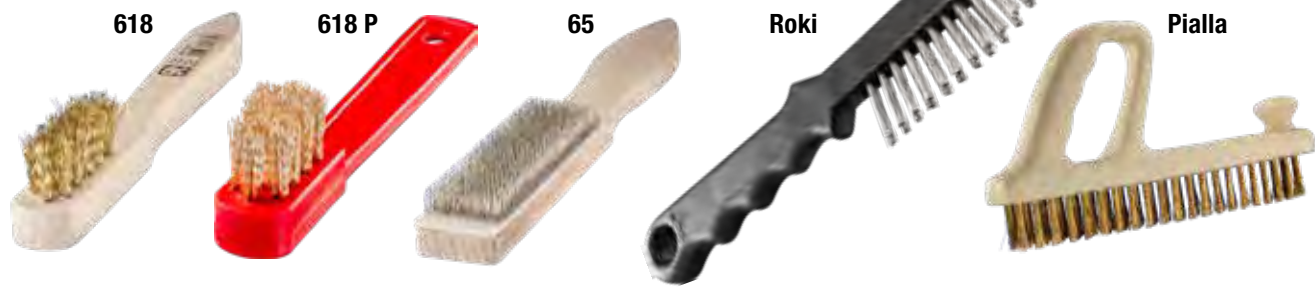

### Spazzole per applicazioni specifiche / Brushes for specific applications

L		A		S		E		Ranghi Rows	ART	Materiale / Material		
mm	inch	mm	inch	mm	inch	mm	inch			Acciaio Steel	Inox S/steel	Ottone Brass
150	6	35	1-3/8	15	9/16	15	9/16	3	618	1820	1822	1810
155	6-1/8	40	1-5/8	18	3/4	22	7/8	4	618 P			1818
225	9	90	3-1/2	22	7/8	9	3/8	2	ROKI	1809		
212	8-3/8	90	3-1/2	8	5/16	27	1	-	65	1808		
252	10	245	9-5/8	30	1-1/8	35	1-3/8	4	Pialla	1811		

618 P manico in plastica / plastic handle

### APPLICAZIONI / APPLICATIONS

**618** Pulizia candele / Spark plugs cleaning. **ROKI** Pulizia delle pinze dei freni / Brake calipers cleaning.

**65** Pulizia lime / File cleaning.

**SLIM** Spazzole di ridotte dimensioni per una migliore spazzolatura manuale di superfici ridotte e con piccole fessure, dove risulta impossibile intervenire con spazzole a mano tradizionali / Small hand brushes ideal for limited areas and surfaces with tiny cracks, where it would be impossible to use traditional hand brushes.







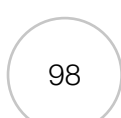
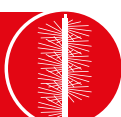



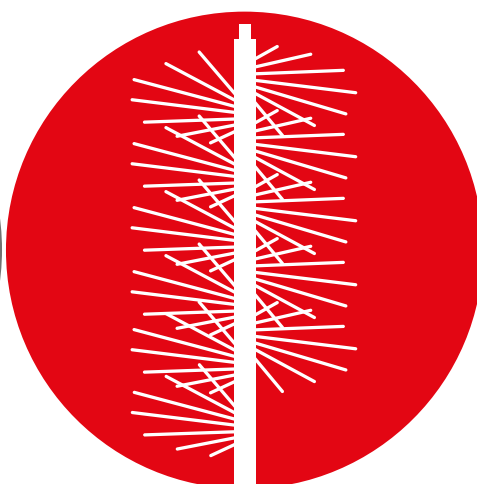



# SCOVOLI TWISTED-IN BRUSHES



## SCOVOLI PER SBAVATURA / TWISTED-IN BRUSHES FOR DEBURRING p. 99

-  > **Scovoli per sbavatura**  
*Twisted-in brushes for deburring* p. 100
-  > **Scovoli manuali**  
*Manual twisted-in brushes* p. 102

## SCOVOLI PER CALDAIE, CAMINI E STUFE A PELLETTA / TUBE BRUSHES FOR BOILERS, CHIMNEYS AND PELLETTA STOVES p. 103

-  > **Scovoli per caldaie**  
*Tube brushes for boilers* p. 104
-  > **Scovoli per pulizia camino**  
*Tube brushes for chimney cleaning* p. 105
-  > **Scovoli per stufe a pellet**  
*Tube brushes for pellet stoves* p. 109
-  > **Varie**  
*Various* p. 111

# > Scovoli per sbavatura / Twisted-in brushes for deburring



[www.sitbrush.tv/t1](http://www.sitbrush.tv/t1)

## DISEGNI TECNICI / TECHNICAL DRAWINGS

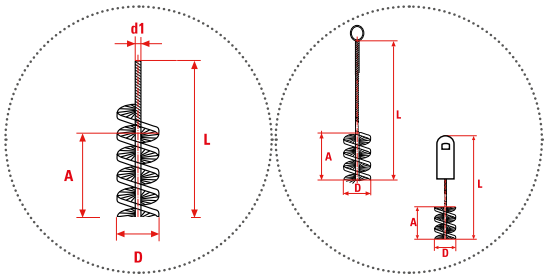

### LEGENDA PACK



**Multipack**  
e.g. 10/100  
Confezione multipla da 10 pezzi con eventuale imballo secondario da 100 pezzi / Multiple pack containing 10 pcs with 100-pcs secondary packaging (if any)

### LEGENDA FILO / FILAMENT

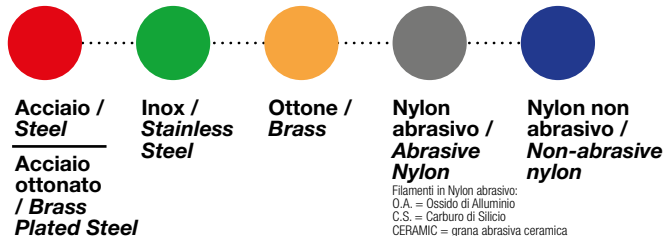

## NOTE / NOTES

**Scovoli a elica singola** Un singolo strato di filamento è arrotolato tra i due fili del gambo.  
**Single spiral twisted-in brushes** A single layer of filament is twisted between two shank wires.

**Gli articoli con Ref ROSSA sono i più venduti / scelte consigliate**  
**Items marked in RED are the best sellers / recommended choice**

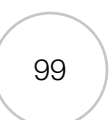
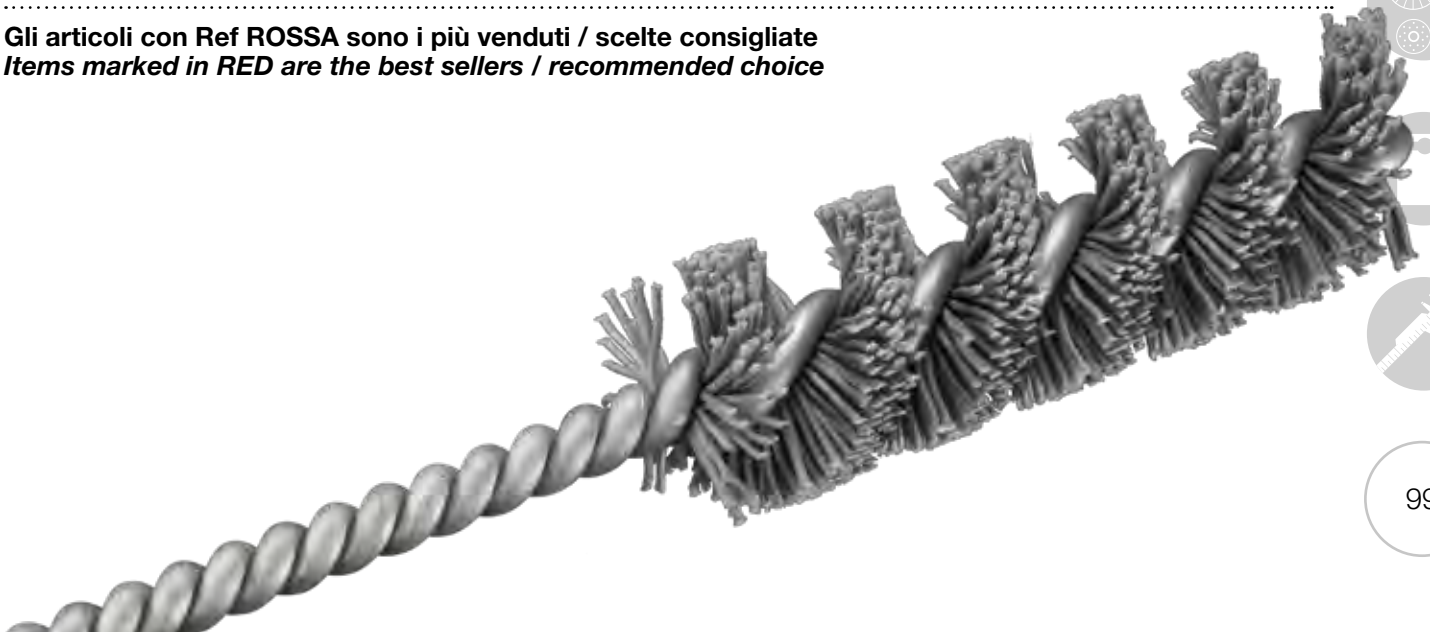



# SCOVOLI / TWISTED-IN BRUSHES

TECH

## > Scovoli per sbavatura / Twisted-in brushes for deburring

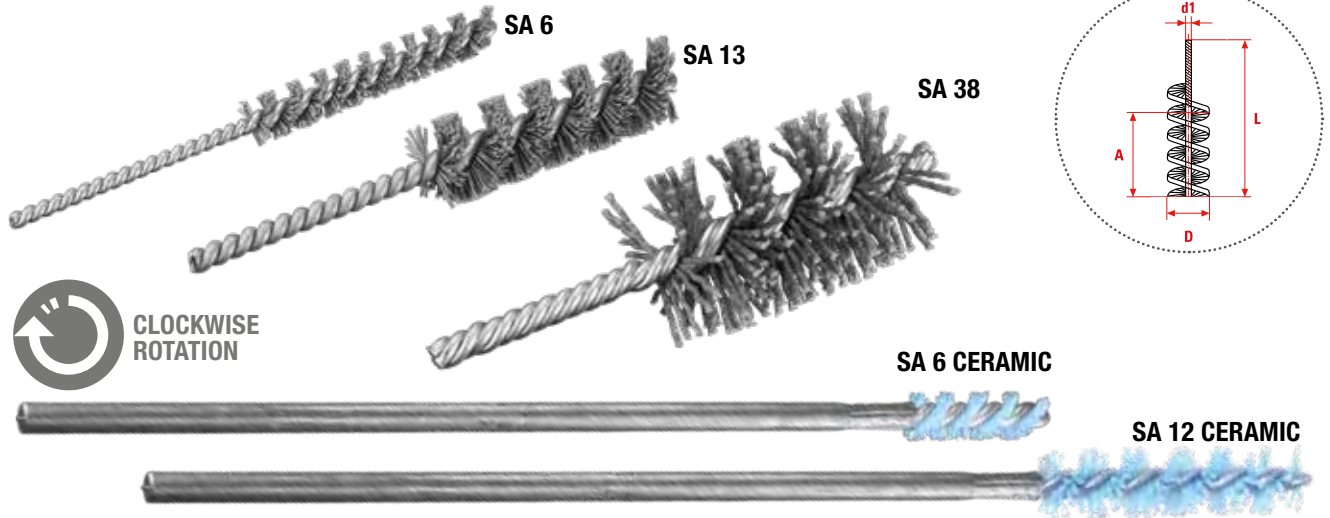

**SA** Scovoli in Nylon abrasivo con filamenti a elica singola.  
**SA CERAMIC** Scovoli in nylon abrasivo ceramico per lavorazioni aggressive con velocità di taglio/lavoro e performance superiori al carburo di silicio. Dotati di un solido gambo in acciaio zincato per facilitare l'uso su macchine utensili CNC, trapani verticali e macchine utensili manuali.

**SA** Abrasive nylon twisted-in brushes with single spiral filament.  
**SA CERAMIC** Twisted-in brushes made of ceramic abrasive nylon for aggressive jobs, with greater operational speed and performance than silicon carbide twisted-in brushes. Fitted with a solid galvanized steel shank for ease of use on CNC machine tools, drill presses and manual machine tools.

### Scovoli in Nylon abrasivo SA / Abrasive nylon twisted-in brushes SA

D		d1		A		L		MAX RPM	2	ART	C.S. 120gr	C.S. 320gr	O.A. 600gr	O.A. 1000gr
mm	inch	mm	inch	mm	inch	mm	inch							
1	3/64	0,6	1/32	20	3/4	100	4	800	10	SA 1				1300
2	5/64	0,6	1/32	20	3/4	100	4	800	10	SA 2				1301
3	1/8	1,5	1/16	20	3/4	100	4	800	10	SA 3				1302
4	5/32	1,5	1/16	20	3/4	100	4	1000	10	SA 4				1303
5	3/16	1,5	1/16	20	3/4	100	4	1000	10	SA 5				1304
6	1/4	3	1/8	65	2-1/2	125	5	1500	10	SA 6	1305	1306		
6,6	1/4	2,5	3/32	25	1	125	5	1000	10	SA 6,6			1334	
8	5/16	3	1/8	65	2-1/2	125	5	1500	10	SA 8	1307	1308		
10	3/8	3,7	9/64	65	2-1/2	125	5	2000	10	SA 10	1309	1310		
11,5	7/16	3,7	9/64	25	1	125	5	2000	10	SA 11,5			1337	
13	1/2	3,7	9/64	65	2-1/2	125	5	2000	10	SA 13	1311	1312		
16	5/8	5,2	3/16	65	2-1/2	125	5	2000	10	SA 16	1313	1314		
19	3/4	5,2	3/16	65	2-1/2	125	5	2000	10	SA 19	1315	1316		
22	7/8	5,7	7/32	65	2-1/2	125	5	2000	10	SA 22	1317	1318		
25	1	5,7	7/32	65	2-1/2	125	5	2000	10	SA 25	1319	1320		
32	1-1/4	5,7	7/32	65	2-1/2	125	5	2000	10	SA 32	1321	1322		
38	1-1/2	5,7	7/32	65	2-1/2	125	5	2000	10	SA 38	1323	1324		
50	2	5,7	7/32	65	2-1/2	125	5	2000	10	SA 50	1325	1326		

### Scovoli in Nylon abrasivo ceramico / Ceramic Nylon twisted-in brushes

D		d1		A		L		MAX RPM	2	ART	0,90mm-0,035"	1mm-0,040"
mm	inch	mm	inch	mm	inch	mm	inch				Cer 180gr	Cer 120gr
6,5	1/4	5	3/16	50	2	200	8	1500	6	SA 6 CERAMIC	2853	
12,5	1/2	6,5	1/4	50	2	200	8	1000	6	SA 12 CERAMIC	2854	
25	1	6,5	1/4	50	2	200	8	1000	6	SA 25 CERAMIC		2855

### APPLICAZIONI / APPLICATIONS

Sbavatura e operazioni di finitura all'interno di componenti tubolari, trapanature e fori conici.  
 Internal deburring and finishing of tubular components and drilled or tapered holes.



# SCOVOLI / TWISTED-IN BRUSHES

TECH

## > Scovoli per sbavatura / Twisted-in brushes for deburring

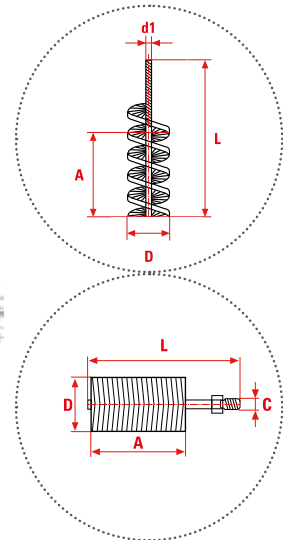
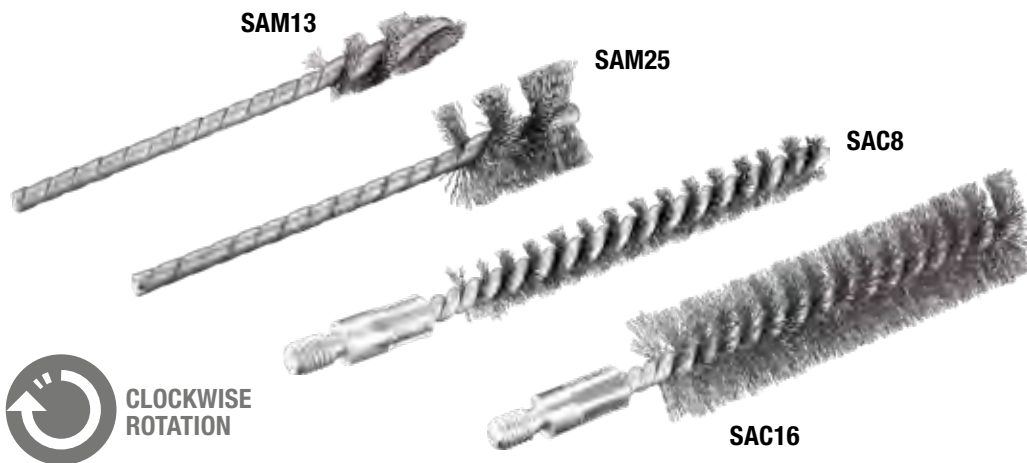

**SAM** Scovoli in acciaio e acciaio inox per lavori di precisione. Possono essere utilizzati sia manualmente sia con utensile elettrico sia con macchine CNC.

**SAM** Steel and stainless steel twisted-in brushes for precision operations. They can be used either manually or with power tools or with CNC machines.

**SAC** Scovoli in acciaio con filamenti a elica singola e attacco filettato.

**SAC** Steel twisted-in brushes with single spiral filament and threaded nut.

### Scovoli in acciaio SAM / Steel wire twisted-in brushes SAM

D		d1		A		L		MAX RPM	2	ART	0,12mm	0,20mm	0,12mm
mm	inch	mm	inch	mm	inch	mm	inch				0,005"	0,008"	0,005"
10	3/8	3,8	5/32	25	1	90	3-1/2	3500	10	<b>SAM 10</b>	<b>2837</b>	<b>2841</b>	<b>2846</b>
13	1/2	3,8	5/32	25	1	90	3-1/2	3500	10	<b>SAM 13</b>	<b>2838</b>	<b>2842</b>	<b>2847</b>
16	5/8	3,8	5/32	25	1	90	3-1/2	3000	10	<b>SAM 16</b>	<b>2839</b>	<b>2843</b>	<b>2848</b>
19	3/4	3,8	5/32	25	1	90	3-1/2	3000	10	<b>SAM 19</b>	<b>2840</b>	<b>2844</b>	
25	1	3,8	5/32	25	1	90	3-1/2	3000	10	<b>SAM 25</b>		<b>2845</b>	

### Scovoli in acciaio SAC / Steel wire twisted-in brushes SAC

D		d1	A		L		MAX RPM	2	ART	0,15mm	0,25mm	0,30mm	0,35mm
mm	inch		mm	inch	mm	inch				0,006"	0,010"	0,012"	0,014"
8	5/16	M6	80	3-1/8	115	4-1/2	1500	10	<b>SAC 8*</b>	<b>1340</b>			
10	3/8	M6	80	3-1/8	115	4-1/2	1500	10	<b>SAC 10</b>	<b>1341</b>			
12	1/2	M6	80	3-1/8	115	4-1/2	1500	10	<b>SAC 12</b>	<b>1342</b>			
14	9/16	M6	80	3-1/8	115	4-1/2	1500	10	<b>SAC 14</b>	<b>1343</b>			
16	5/8	M6	80	3-1/8	115	4-1/2	800	10	<b>SAC 16</b>	<b>1344</b>			
20	3/4	M6	80	3-1/8	115	4-1/2	800	10	<b>SAC 20</b>	<b>1345</b>			
25	1	W 3/8	100	4	150	6	500	10	<b>SAC 25</b>		<b>1346</b>		
30	1-1/8	W 1/2	100	4	160	6	500	10	<b>SAC 30</b>			<b>1347</b>	
38	1-1/2	W 1/2	100	4	160	6	500	10	<b>SAC 38</b>			<b>1348</b>	
40	1-5/8	W 1/2	100	4	160	6	500	10	<b>SAC 40</b>				<b>1349</b>
50	2	W 1/2	100	4	160	6	500	10	<b>SAC 50</b>				<b>1350</b>

**SAC** Su richiesta, sono disponibili attacchi filettati differenti.  
Upon request, different threaded nuts are available.

\* Ø 0,10mm - 0,004"

### APPLICAZIONI / APPLICATIONS

Rimozione dei residui di lavorazioni di foratura; sbavatura di fori trasversali, lisci o filettati; pulizia di cavità e superfici di difficile accesso.

Removal of drilling residues; deburring of cross holes, both threaded and smooth; cleaning of cavities and hard to reach surfaces.

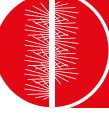



# SCOVOLI / TWISTED-IN BRUSHES



## > Scovoli manuali / Manual twisted-in brushes

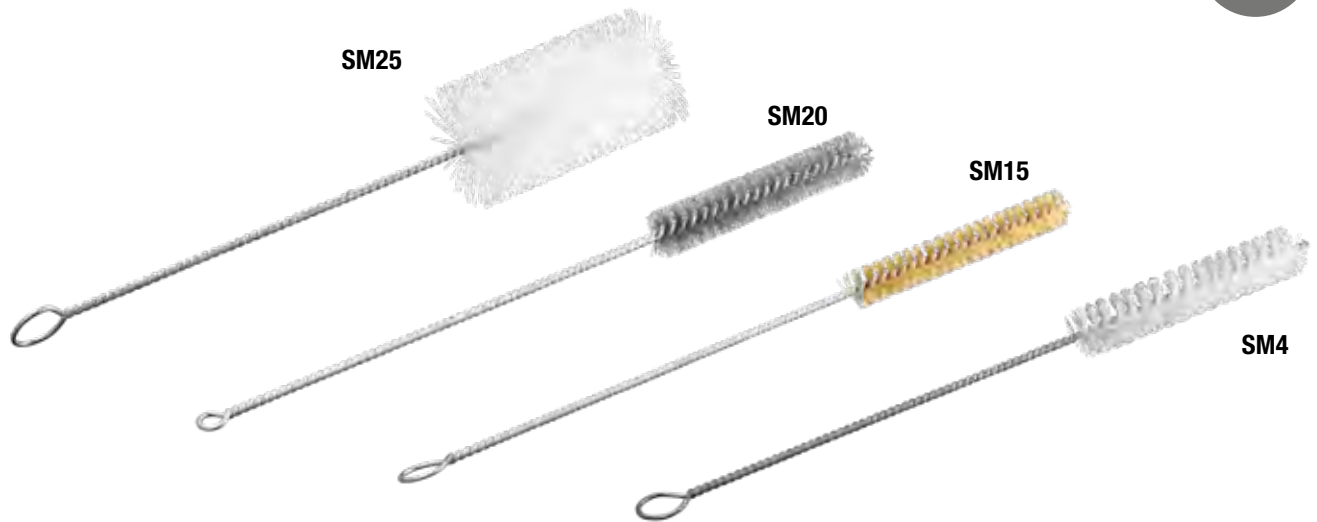

Scovoli cilindrici per pulizia manuale disponibili in diverse dimensioni e materiali.

Twisted-in brushes for manual use. Available in different dimensions and materials.

### Scovoli manuali SM / Manual twisted-in brushes SM

D		A		L		ART	Acciaio Steel	Inox S-Steel	Ottone Brass	Nylon
mm	inch	mm	inch	mm	inch					
3	1/8	100	4	300	12	SM 3	2801	2810	2819	2828
4	1/8	100	4	300	12	SM 4	2802	2811	2820	2829
6	1/4	100	4	300	12	SM 6	2803	2812	2821	2830
8	5/16	100	4	300	12	SM 8	2804	2813	2822	2831
10	3/8	100	4	300	12	SM 10	2805	2814	2823	2832
12	1/2	100	4	300	12	SM 12	2806	2815	2824	2833
15	9/16	100	4	300	12	SM 15	2807	2816	2825	2834
20	3/4	100	4	300	12	SM 20	2808	2817	2826	2835
25	1	100	4	300	12	SM 25	2809	2818	2827	2836
30	1-1/8	100	4	300	12	SM 30	2850			
40	1-5/8	100	4	300	12	SM 40	2851			
50	2	100	4	300	12	SM 50	2852			

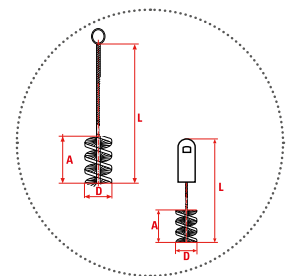

SM Negli scovoli manuali SM il diametro del filo varia a seconda del materiale e delle dimensioni dello scovolo. Wire diameter varies according to the fill material and the brush size.

### Scovoli manuali per pulizia tubi / Manual twisted-in brushes for pipe cleaning

D		A		L		ART	0,25mm	0,40mm
mm	inch	mm	inch	mm	inch		0,010"	0,016"
20	3/4	190	7-1/2	500	19-3/4	SS 20		1927
25	1	105	4-1/8	780	30-3/4	SG 25	1928	1929
30	1-1/8	105	4-1/8	780	30-3/4	SG 30	1930	1931

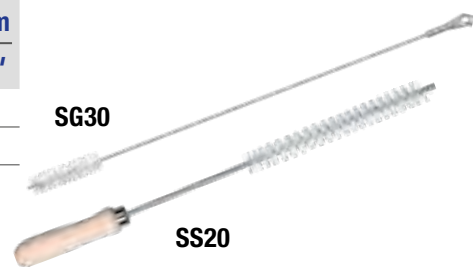

### Scovoli in acciaio inox / Stainless steel twisted-in brushes

D		A		L		ART	0,10mm	0,15mm	0,20mm
mm	inch	mm	inch	mm	inch		0,004"	0,006"	0,008"
12	7/16	15	5/8	150	6	10/80	STU12	1924	
15	5/8	20	3/4	150	6	10/80	STU15	1925	
22	7/8	25	1	150	6	10/80	STU22		1926



### APPLICAZIONI / APPLICATIONS

SM Pulizia e sbavatura di tubi, fori e cavità di qualsiasi tipo e materiale.

SS/SG Pulizia di caldaie a gas.

STU Pulizia di terminali idraulici ed altri componenti in acciaio inox.

SM Cleaning and deburring of tubes, holes and cavities of any kind and material.

SS/SG Cleaning of gas boilers.

STU Cleaning of hydraulic terminal and stainless steel components.

**> Scovoli per caldaie, camini e stufe a pellet /  
Tube brushes for boilers, chimneys and pellet stoves**



**GUARDA IL VIDEO  
WATCH THE VIDEO**



[www.sitbrush.tv/t2](http://www.sitbrush.tv/t2)

**DISEGNI TECNICI / TECHNICAL DRAWINGS**

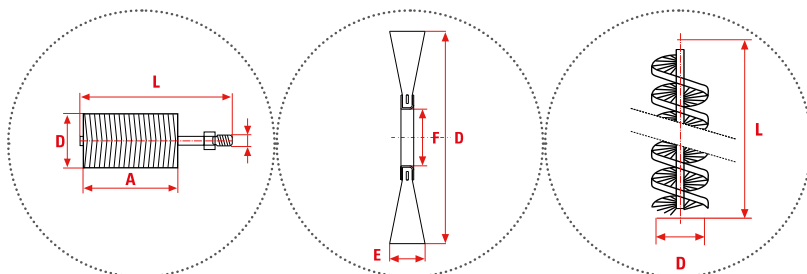

**LEGENDA  
PACK**

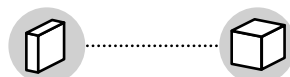

**Single pack**

e.g. 1/24  
Confezione singola con eventuale imballo secondario da 24 pezzi / Single pack with 24-pcs secondary packaging (if any)

**Multipack**

e.g. 12/96  
Confezione multipla da 12 pezzi con eventuale imballo secondario da 96 pezzi / Multiple pack containing 12 pcs with 96-pcs secondary packaging (if any)

**LEGENDA  
FILO / FILAMENT**



**Acciaio / Steel**  
Acciaio  
ottonato /  
Brass Plated  
Steel

**Inox / Stainless  
Steel**

**Nylon non  
abrasivo /  
Non-abrasive  
nylon**

**NOTE / NOTES**

Tutti gli scovoli per la pulizia di caldaia e camino sono dotati di attacco filettato M12. A richiesta disponibile M10 maschio e 1/2" maschio.

*All tube brushes for the cleaning of boilers and chimneys are equipped with a threaded connection M12. On request M10 and 1/2" male threads are available.*

**Gli articoli con Ref ROSSA sono i più venduti / scelte consigliate**  
*Items marked in RED are the best sellers / recommended choice*

**GUARDA IL VIDEO  
WATCH THE VIDEO**



[sitbrush.tv/kpp](http://sitbrush.tv/kpp)





# SCOVOLI / TUBE BRUSHES

## > Scovoli per caldaie / Tube brushes for boilers

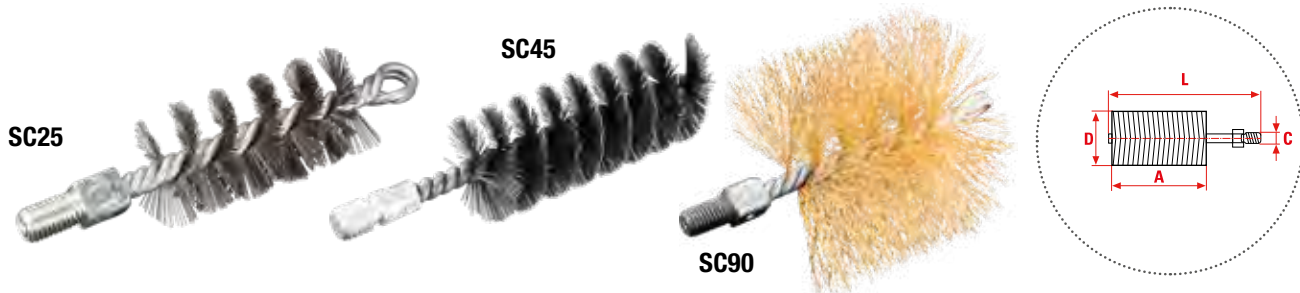

Scovoli ad elica semplice in filo di acciaio temprato liscio con anima in filo d'acciaio o in Nylon bianco liscio e acciaio ottonato ondulato, meno aggressivi.

Single spiral tube brushes made of tempered straight steel wire with steel wire core, or less aggressive tube brushes made of white straight nylon or brass plated crimped wire.

### Scovoli SC / Twisted-in brushes SC

OTTONATO  
BRASS-COATED

D		A		L		ART	0,35mm	0,50mm	Nylon	0,30mm	
mm	inch	mm	inch	mm	inch		0,014"	0,020"		0,012"	
20	3/4	95	3-3/8	160	6-1/4	12	SC 20	1900**		1950***	
25	1	95	3-3/8	160	6-1/4	12	SC 25	1901**		1951***	
30	1-1/8	95	3-3/8	160	6-1/4	12	SC 30	1902	1977**	1952	
35	1-3/8	95	3-3/8	160	6-1/4	12	SC 35	1903		1953	
40	1-5/8	95	3-3/8	160	6-1/4	12	SC 40	1904	1979**	1954	
45	1-3/4	95	3-3/8	160	6-1/4	12	SC 45	1905		1955	
50	2	95	3-3/8	160	6-1/4	12	SC 50	1906	1981**	1956	
55	2-1/8	95	3-3/8	160	6-1/4	12	SC 55	1907		1957	
60	2-3/8	95	3-3/8	160	6-1/4	12	SC 60	1908	1983**	1958	
65	2-1/2	95	3-3/8	160	6-1/4	12	SC 65	1909		1959	
70	2-3/4	95	3-3/8	160	6-1/4	12	SC 70	1910		1960	
75	3	95	3-3/8	160	6-1/4	12	SC 75	1911		1961	
80	3-1/8	95	3-3/8	160	6-1/4	12	SC 80	1912	1987**	1962	
85	3-3/8	95	3-3/8	160	6-1/4	12	SC 85	1913		1963	
90	3-1/2	95	3-3/8	160	6-1/4	12	SC 90	1914		1964	
100	4	95	3-3/8	160	6-1/4	12	SC 100	1916	1991**	1966	
120	4-3/4	95	3-3/8	160	6-1/4	12	SC 120		1917*	1992**	1967
130	5-1/8	95	3-3/8	160	6-1/4	12	SC 130		1918		1968
140	5-1/2	95	3-3/8	160	6-1/4	6	SC 140		1919		1969
150	6	95	3-3/8	160	6-1/4	6	SC 150		1940		
160	6-1/4	95	3-3/8	160	6-1/4	6	SC 160		1941		
180	7-1/8	95	3-3/8	160	6-1/4	6	SC 180		1942		
200	8	95	3-3/8	160	6-1/4	6	SC 200		1943*		
250	10	95	3-3/8	160	6-1/4	6	SC 250		1944*		
300	12	95	3-3/8	160	6-1/4	6	SC 300		1945*		

\* Ref 1917: Ø 0,45mm / 0,018";  
Ref 1943,1944,1945: Ø 0,60mm / 0,024";  
\*\* Ref 1977: Ø 0,40mm / 0,016";  
Ref 1979,1981,1983: Ø 0,60mm / 0,024";  
Ref 1987: Ø 0,80mm / 0,031";  
Ref 1991: Ø 1mm / 0,040";  
Ref 1992: Ø 1,20mm / 0,047";  
Ref 1900: Ø 0,25mm / 0,010";  
Ref 1901: Ø 0,25mm / 0,010";  
\*\*\*Ref 1950,1951: senza occhio / without hole

A richiesta, tutti gli scovoli SC possono essere sagomati.  
On request all tube brushes can be shaped.

### Scovoli SC Light / Twisted-in brushes SC Light

D		A		L		ART	0,35mm	Nylon	
mm	inch	mm	inch	mm	inch		0,014"		
80	3-3/16	95	3-3/8	160	6-5/16	12/120	SC 80	1976	1989
100	4	95	3-3/8	160	6-5/16	12/120	SC 100	1985	1990
120	4-3/4	95	3-3/8	160	6-5/16	12/120	SC 120	1986	1994

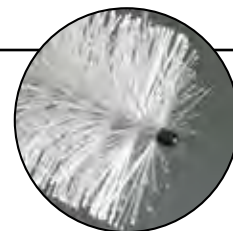

Gli scovoli SC Light possono essere ordinati esclusivamente in quantità pari o multiple di 120pz

L		ART*	REF
mm	inch		
1000	39-3/8	1 Manico flessibile / Flexible handle	1920
1500	59	1 Manico flessibile / Flexible handle	1921
1000	39-3/8	1 Asta rigida / Rigid rod	1922

\* Accessori in Acciaio / \* Steel accessories

### APPLICAZIONI / APPLICAZIONI

Pulizia interna di tubi. Gli scovoli in Nylon sono adatti alla pulizia di tubi in acciaio inossidabile.  
Internal cleaning of tubes. Nylon tube brushes are suitable for the cleaning of stainless steel tubes.

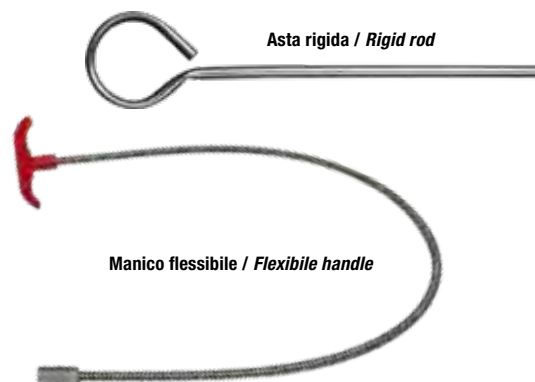

## SCOVOLI / TUBE BRUSHES

### > Scovoli per pulizia camino / Tube brushes for chimney cleaning

KIT CAMINET



KIT CAMINET NYLON



Kit completo per la pulizia del camino, con scovoli in piattina d'acciaio, nylon stampato o nylon liscio.

Complete set for chimney cleaning with tube brushes made of flat steel wire, straight Nylon or moulded Nylon.

### KIT CAMINET

Descrizione / Description		ART	Ref
6 Aste L = 1400mm - 55-1/8" + 1 Flex + 1 Scovolo tondo ø 250mm - 10" 6 Rods L = 1400mm - 55-1/8" + 1 Flex + 1 Round tube brushes ø 250mm - 10"	12	<b>KIT CAMINET FLEX</b> 8,4m - 330,7"	<b>1881</b>
5 Aste L = 1400mm - 55-1/8" + 1 Scovolo tondo ø 250mm - 10" 5 Rods L = 1400mm - 55-1/8" + 1 Round tube brush ø 250mm - 10"	12	<b>KIT CAMINET</b> 7m - 275,6"	<b>1878</b>
5 Aste L = 1400mm - 55-1/8" + 1 Scovolo tondo in Nylon ø 250mm - 10" 5 Rods L = 1400mm - 55-1/8" + 1 Nylon round tube brush ø 250mm - 10"	12	<b>KIT CAMINET NYLON</b> 7m - 275,6"	<b>1948</b>

### APPLICAZIONI / APPLICATIONS

Pulizia del camino. Gli scovoli in nylon sono consigliati per camini in acciaio inox.  
For chimney cleaning. Nylon tube brushes are ideal for stainless steel chimneys.

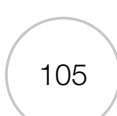
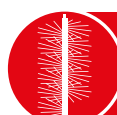



## SCOVOLI / TUBE BRUSHES



### > Scovoli per pulizia camino / Tube brushes for chimney cleaning



Scovoli di diverse forme in piattina d'acciaio per ogni tipologia di camino e di canna fumaria.

Tube brushes made of flat steel wire. They are suitable for any kind of chimney.

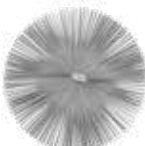
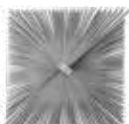
### Scovoli in piattina d'acciaio / Flat steel tube brushes

	D		ART	3,0x0,4mm - 0,12"x0,016"	2,75x0,35 mm - 0,10"x0,014"
	mm	inch		Imballo multiplo / Multipack	Imballo multiplo / Multipack
	ø 120	4-3/4	24	<b>STP120</b>	<b>1891*</b>
	ø 150	6	24	<b>STP150</b>	<b>1850*</b>
	ø 180	7-1/8	18	<b>STP180</b>	<b>1849</b>
	ø 200	8	18	<b>STP200</b>	<b>1852</b>
	ø 220	8-5/8	12	<b>STP220</b>	<b>1842</b>
	ø 250	10	12	<b>STP250</b>	<b>1854</b>
	ø 300	12	12	<b>STP300</b>	<b>1856</b>
	ø 350	14	8	<b>STP350</b>	<b>1858</b>
	ø 400	16	8	<b>STP400</b>	<b>1859</b>
	ø 500	20	8	<b>STP500</b>	<b>1883</b>
	200x200	8x8	18	<b>SQP200</b>	<b>1862</b>
	250x250	10x10	12	<b>SQP250</b>	<b>1864</b>
	300x300	12x12	8	<b>SQP300</b>	<b>1866</b>
	350x350	14x14	6	<b>SQP350</b>	<b>1885</b>
	400x400	16x16	6	<b>SQP400</b>	<b>1847</b>
	200x350	8x14	12	<b>SRP200</b>	<b>1868</b>
	250x350	10x14	8	<b>SRP250 B</b>	<b>1886</b>
	250x400	10x16	8	<b>SRP250</b>	<b>1870</b>
	300x400	14x16	8	<b>SRP300</b>	<b>1887</b>

\*Ref 1891, 1850: 1,80mmx0,45mm / 0,071"x0,018"

- Etichetta informativa con Referenza, Diametro, Barcode  
Informative label with Reference, Diameter, Barcode.

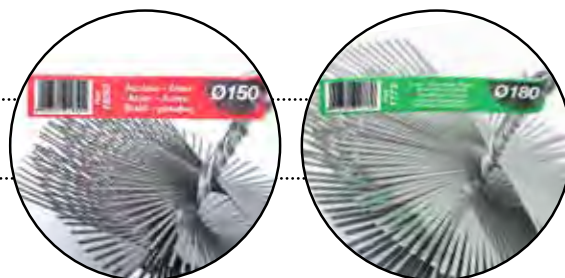

### APPLICAZIONI / APPLICATIONS

Per pulire, ottenere un perfetto tiraggio ed evitare l'autocombustione del camino e l'emissione di monossido di carbonio.  
For chimney cleaning and perfect draught. To prevent chimneys to ignite and to reduce emissions of carbon monoxide.

## SCOVOLI / TUBE BRUSHES

### > Scovoli per pulizia camino / Tube brushes for chimney cleaning



Scovoli di diverse forme in nylon stampato o nylon liscio per ogni tipologia di camino e di canna fumaria.

Tube brushes made of straight Nylon or moulded Nylon with various shapes. They are suitable for any kind of chimney.

### Scovoli in Nylon / Nylon tube brushes

	D		ART	Nylon ondulato / crimped	Nylon liscio / straight
	mm	inch		1,3x1 x1,8mm 0,051"x0,070"	2mm 0,080"
	ø 100	4	24	<b>STN100</b>	<b>1770</b>
	ø 120	4-3/4	24	<b>STN120</b>	<b>1899</b>
	ø 150	6	24	<b>STN150</b>	<b>1893</b>
	ø 180	7-1/8	18	<b>STN180</b>	<b>1894</b>
	ø 200	8	18	<b>STN200</b>	<b>1892</b>
	ø 250	10	12	<b>STN250</b>	<b>1860</b>
	ø 300	12	12	<b>STN300</b>	<b>1861</b>

- Etichetta informativa con Referenza, Diametro, Barcode  
Informative label with Reference, Diameter, Barcode.



### APPLICAZIONI / APPLICATIONS

Per pulire, ottenere un perfetto tiraggio ed evitare l'autocombustione del camino e l'emissione di monossido di carbonio. Gli scovoli in Nylon sono adatti a camini in acciaio Inox.  
Ideal for chimney cleaning and perfect draught. To prevent chimneys to ignite and to reduce emissions of carbon monoxide. Nylon tube brushes are ideal for stainless steel chimneys.

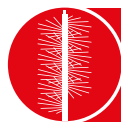



## SCOVOLI / TUBE BRUSHES

### > Scovoli per pulizia camino / Tube brushes for chimney cleaning

A



F



F

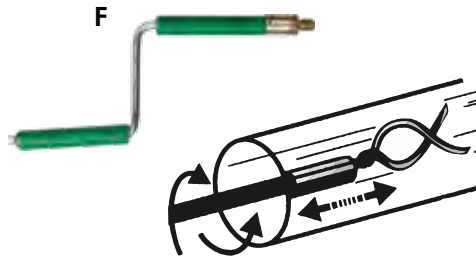

C



D



Aste in PPL con attacco M12 per montaggio modulare, flessibili e resistenti. Aste con autobloccante per una maggiore sicurezza di impiego.

Flexible and resistant PPL rods with M12 thread for modular assembling. Rods with self-locking system for a safer use.

### Aste e accessori / Rods and accessories

	D		L			ART	Ref
	mm	inch	mm	inch			
A	17	5/8	600	23-5/8	25	Asta rossa / Red rod	1935
A	17	5/8	1000	39-3/8	25	Asta rossa / Red rod	1872
A	17	5/8	1400	55-1/8	25	Asta rossa / Red rod	1873
A	17	5/8	2000	78-3/4	25	Asta rossa / Red rod	1874
B	17	5/8	1000	39-3/8	1	KIT n°6 aste rosse / KIT n°6 red rods	1880
E	18	3/4	1000	39-3/8	5	Asta verde autobloccante / Green self-blocking rod	1882
E	18	3/4	1400	55-1/8	5	Asta verde autobloccante / Green self-blocking rod	1875
E	18	3/4	2000	78-3/4	5	Asta verde autobloccante / Green self-blocking rod	1848
G	20	3/4	1000	39-3/8	1	Asta nera autobloccante / Black self-blocking rod	4240
C					1/12	Maniglia / Rod Handle	1936
D			240	9-1/2	1/25	Attacco flessibile / Flexible connection	1876
F					1	Manovella / Crank	1812
F					1	Spirale / Spiral	1813

G Asta con adattatore in ottone antiscintilla / Rods with spark-proof brass adapter.

F Accessori per aste verdi autobloccanti / Accessories for green self-locking rods.

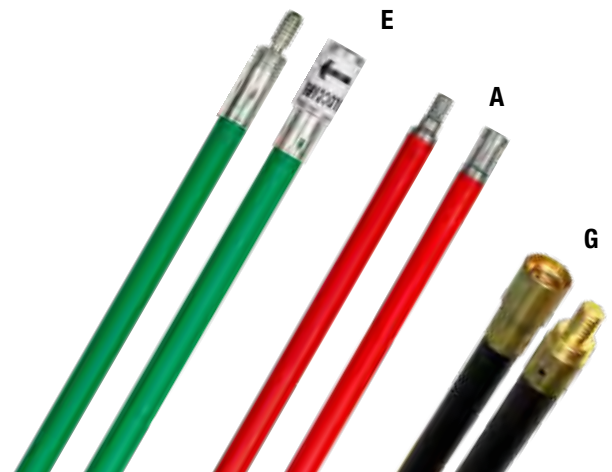

### APPLICAZIONI / APPLICATIONS

Aste e accessori per scovoli per pulizia del camino.  
Rods and accessories for chimney cleaning tube brushes.

# SCOVOLI / TUBE BRUSHES

## > Scovoli per stufe a pellet / Tube brushes for pellet stoves

KPP FLEX PRO 10m

KPP 80/100

KPP Light

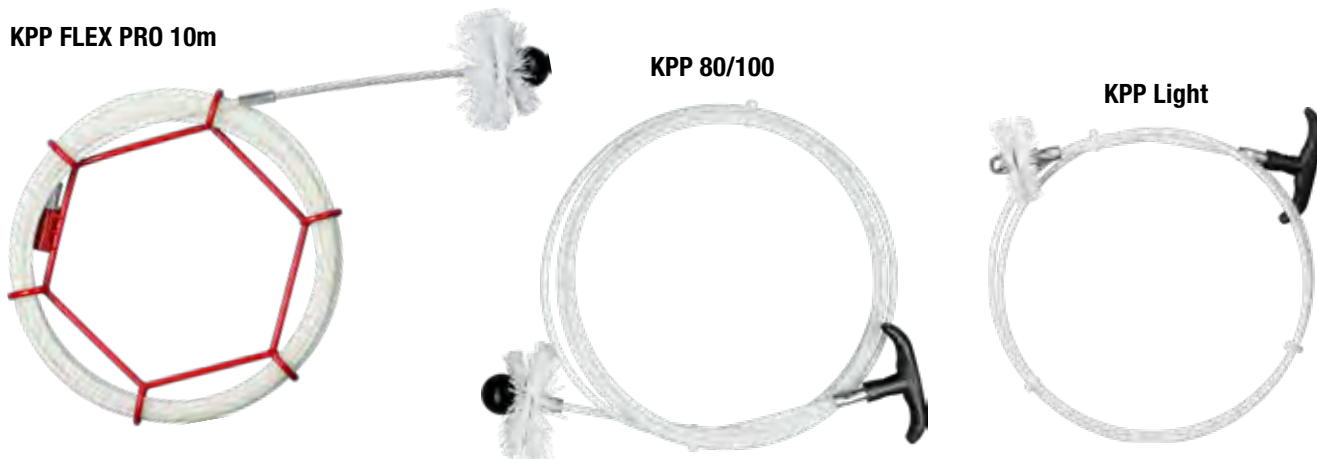

Kit costituito da un'asta in vetroresina estremamente resistente e flessibile, una maniglia plastica che ne facilita l'utilizzo, 1 o 2 anelli di nylon di prima qualità ed una chiusura con dado M12 (KIT Light) o con sfera nera M12 che guida lo scovolo anche nelle curve di 90°!

Kit made up of a flexible and resistant fiberglass rod, a plastic handle that facilitates its use, 1 or 2 Nylon single section wheels of the best quality and closed by a M12 nut (KIT Light) or M12 black sphere, which helps cleaning 90° bends of pipes.

### KIT PuliPellet

D		Descrizione / Description	ART	L= 2m	L= 3m	L= 5m	L= 10m
mm	inch			79"	118"	197"	394"
80	3-1/8	Asta con terminale in cavo flessibile* + Maniglia + Sfera + Anelli 80 mm e 100 mm in Nylon <i>Rod with flexible cable* + Handle + Sphere + Single section wheels Ø 3-1/8" + Single section wheels Ø 4"</i>	KPP Flex Pro 80/100		1934	1845	
100	4						
80	3-1/8	Aspo metallico + Asta con terminale in cavo flessibile* + Sfera + Anelli 80 mm e 100 mm in Nylon <i>Metallic reel + Rod with flexible cable* + Sphere + Single section wheels Ø 3-1/8" + Single section wheels Ø 4"</i>	KPP Flex Pro 80/100				1949
100	4						
80	3-1/8	Asta + Maniglia + Sfera + Anello 100mm - 4" + Anello 80 mm <i>Rod + Handle + Sphere + Single section wheels Ø 4" + Single section wheels Ø 3-1/8"</i>	KPP 80/100	1895	1897		
100	4						
80	3-1/8	Asta + Maniglia + Dado + Anello 80 mm <i>Rod + Handle + Dado + Single section wheels Ø 3-1/8"</i>	KPP Light	1973	1982		

\* Il terminale in cavo flessibile facilita la pulizia di canna fumaria e canalizzazioni anche in caso di tratti curvi.  
*The flexible terminal makes it easy to clean chimneys and canalizations in case of curved sections.*

**GUARDA IL VIDEO  
WATCH THE VIDEO**

[sitbrush.tv/kpp](http://sitbrush.tv/kpp)



### APPLICAZIONI / APPLICATIONS

Pulizia e manutenzione di stufe a pellet, canne fumarie, tubazioni pluviali e canalizzazioni.  
*Cleaning and maintenance of pellet stoves, chimneys, pipes downspouts and canalizations.*





## SCOVOLI / TUBE BRUSHES

### > Scovoli per stufe a pellet / Tube brushes for pellet stoves



### Accessori Pulipellet / Pulipellet Accessories

D		Descrizione / Description		ART	Ref	
mm	inch					
A		Asta in fibra di vetro L=2000mm - 79" ø 5,6mm - 7/32" + Boccola M12 Fiberglass rod L=2000mm - 79" ø 5,6mm - 7/32" + Bushing M12	1	Prolunga	1998	
B		Sfera nera M12 / Black sphere M12	1	Sfera	1997	
C		Maniglia M12 / Handle M12	1/12	Maniglia	1936	
D		Boccola di congiunzione M12 / Bushing M12	1	Boccola	1993	
E	80	3-1/4	Anello in Nylon Ø 0,80mm - 0,031" / Ø 0,80mm - 0,031" Nylon single section wheel	6/72	Anello 14/80	1999
E	100	4	Anello in Nylon Ø 0,80mm - 0,031" / Ø 0,80mm - 0,031" Nylon single section wheel	6/48	Anello 14/100	2000
E	120	4-3/4	Anello in Nylon Ø 0,80mm - 0,031" / Ø 0,80mm - 0,031" Nylon single section wheel	6/48	Anello 14/120	2001
E	150	6	Anello in Nylon Ø 0,80mm - 0,031" / Ø 0,80mm - 0,031" Nylon single section wheel	6/24	Anello 13/150	2006
F	80	3-1/4	Anello in Acciaio ondulato / Crimped steel single section wheel	6/72	Anello 12/80	1978
G	80	3-1/4	Anello in Nylon abrasivo / Abrasive nylon single section wheel 320gr	6/72	Anello 14/80	1988
H	80	3-1/4	Scovolo in Nylon liscio / Smooth Nylon tube brush	12	SC80	1987
I	80	3-1/4	Scovolo in acciaio liscio / Smooth steel tube brush	12	SC80	1912
L	80	3-1/4	Scovolo in acciaio ottonato / Brass-plated steel tube brush	12	SC80	1962

**A** L'asta del kit prolunga può essere montata tramite la boccola compresa nel kit Pulipellet, ad eccezione della versione Light.  
The rod of the extension kit can be mounted through the adapter included in every Pulipellet kit, with the exception of the Light version.

**E, F, G** Gli anelli sono disponibili, su richiesta, nei diametri da 40mm - 1-5/8" a 140 mm - 5-1/2".  
On request, single section wheel brushes are available in diameters from 40mm - 1-5/8" to 140 mm - 5-1/2".

**H, I, L** Gli scovoli sono disponibili, su richiesta, nei diametri da 20mm - 3/4" a 300mm - 12".  
On request, tube brushes are available in diameters from 20mm - 3/4" to 300mm - 12".

### Stik



1/12

ART

Ref

STIK

1995



**STIK** Pennello in acciaio e raschietto per mantenere pulita la stufa a pellet e migliorarne l'efficienza di combustione.  
Steel end brush with scraper for keeping the pellet stove clean and improving its combustion efficiency.



### APPLICAZIONI / APPLICATIONS

**STIK** Il pennello permette di rimuovere i residui, l'altra estremità raschia le incrostazioni.

**STIK** Scrape off incrustations with the hard end, remove residues with the end brush.

GUARDA IL VIDEO  
WATCH THE VIDEO



sitbrush.tv/stik



# SCOVOLI / TUBE BRUSHES

> **Varie / Various**



Scovoli di piccole dimensioni per la pulizia di terminali e piccoli componenti.

*Small tube brushes for terminals and small components cleaning.*

## Scovoli per batterie / Tube brushes for battery terminals

D		d		A		L		ART	0,20mm 0,008"
mm	inch	mm	inch	mm	inch	mm	inch		
25	1	15	9/16	55	2-1/8	115	4-1/2	SB	1933

## Scovoli per termosifoni / Tube brushes for radiators

D		A		L		ART	Nylon bianco liscio / White straight nylon 0,20mm - 0,008"
mm	inch	mm	inch	mm	inch		
45	1-3/4	310	12-1/4	930	36-5/8	STER	1938

## Scovoli per trapano / Tube brushes for drill

D		d1		Shank		L		A		MAX RPM	ART	0,30mm 0,012"
mm	inch	mm	inch	mm	inch	mm	inch	mm	inch			
28	1-1/8	8	5/16	25	1	90	3-1/2	50	2	500	ST	1932
28	1-1/8	8	5/16	25	1	90	3-1/2	50	2	500	B ST	0450



**NEW**

ST



## APPLICAZIONI / APPLICATIONS

**SB** Pulizia degli elementi delle batterie di auto, moto e scooter, in particolare pulizia e disincrostazione di morsetti e terminali.

**STER** Pulizia di termosifoni e per la pulizia a freddo dei tubi interni delle stufe

**ST** Pulizie generiche su materiali ferrosi e non ferrosi. Sbavature e finiture post lavorazione con trapano.

**SB** Ideal for cars and motorbikes batteries cleaning, particularly suited for cleaning and deslagging of clamps and pins.

**STER** Ideal for radiators cleaning and for cold cleaning of stove inner tubes.

**ST** Suitable for cleaning operations on both ferrous and non-ferrous materials, deburring and post-processes finishing.

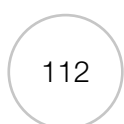
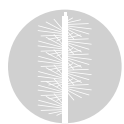

# STRIP



## STRIP

p. 114



> **Strip porte / Strip brushes for doors**

p. 115



> **Strip portoni / Strip brushes for main doors**

p. 116



> **Guaine / Tapes**

p. 117



> **Strip industriali / Industrial strip brushes**

p. 118





# > Strip

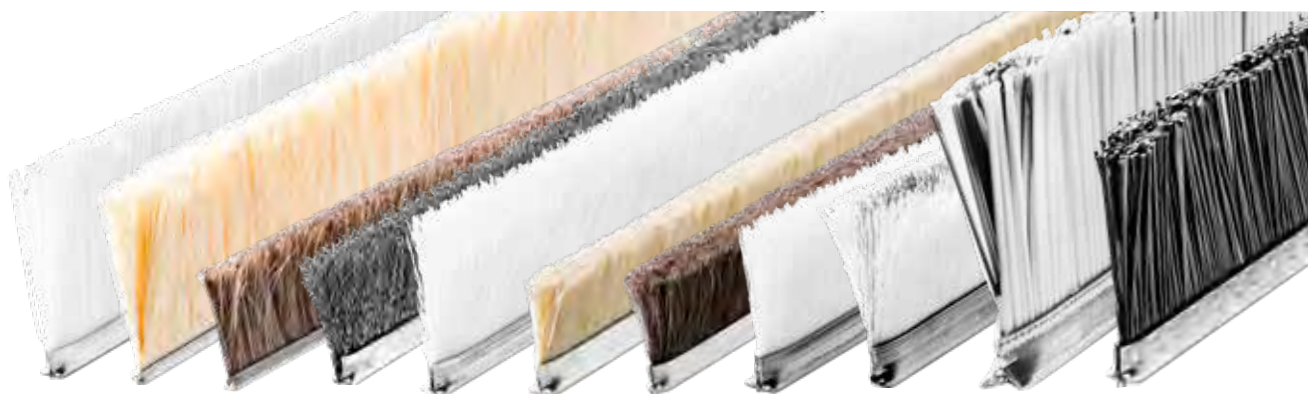

## DISEGNI TECNICI / TECHNICAL DRAWINGS

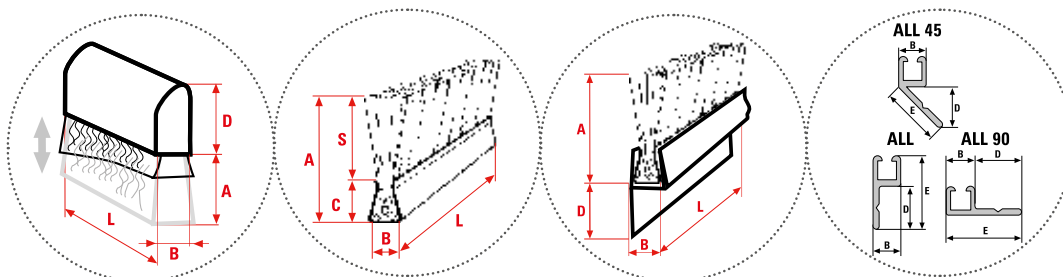

### LEGENDA PACK



Gli strip SIT sono venduti a metratura / SIT strip brushes are sold per meter.

### LEGENDA FILO / FILAMENT

- PPL B.L.: polipropilene bianco liscio / white straight polypropylene
- PPL B.O.: polipropilene bianco ondulato / white crimped polypropylene
- PPL N.L.: polipropilene nero liscio / black straight polypropylene
- NYL B.L.: nylon bianco liscio / white straight nylon
- NYL N.Z.: nylon nero zigrinato / black knurled nylon
- CRINE GRIGIO: crine di cavallo / horse hair
- TAMPICO: fibra vegetale / vegetable fiber
- ACC.: acciaio ondulato / crimped steel
- INOX: acciaio inossidabile / stainless steel
- OTTONE OND: ottone ondulato / crimped brass
- PIAT. ACC.: piattina d'acciaio / flat steel

## NOTE / NOTES

Su richiesta sono disponibili filamenti sintetici resistenti ad alte temperature (fino a 250°C - 482°F), conduttori o certificati per uso alimentare.

On request, high temperature resistant synthetic filaments (up to 250°C - 482°F), electrical conductors synthetic filaments, certified synthetic filaments for food industry, are available.

Gli articoli con Ref ROSSA sono i più venduti / scelte consigliate  
Items marked in RED are the best sellers / recommended choice

# STRIP

## > Strip porte / Strip brushes for doors



Spazzola lineare Strip con supporto in plastica o in alluminio. Aletta con adesivo per un pratico e facile montaggio. L'autolivellante si adatta meglio alla superficie del pavimento.

Linear Strip Brush with plastic or aluminum support with adhesive tape for handy and easy installation. Self-leveling strips adapt perfectly to the floor surface.

### Strip porte / Strip brushes for doors

L		B		A		D			PVC Marrone	PVC Bianco	PVC Trasparente
mm	inch	mm	inch	mm	inch	mm	inch		Brown PVC	White PVC	Transparent PVC
1000	39-3/8	2,5	3/32	20	3/4	21	7/8	1/25 pz	<b>1131</b>	<b>1130</b>	<b>1129</b>

### Strip autolivellanti / Self-leveling strip brushes

L		B		A		D			Alluminio Bianco	Alluminio Marrone
mm	inch	mm	inch	mm	inch	mm	inch		White Aluminum	Brown Aluminum
1000	39-3/8	2,5	3/32	20	3/4	28	1-1/8	1/12 pz	<b>1133</b>	<b>1134</b>



### APPLICAZIONI / APPLICATIONS

Applicati nel profilo inferiore delle porte e dei serramenti per fare tenuta e protezione da aria, umidità e polvere.

Applied in the lower profile of doors and windows to seal and protect from air, moisture and dust.





# STRIP

TECH

## > Strip portoni / Strip brushes for main doors

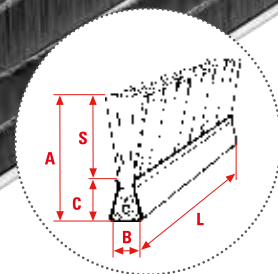
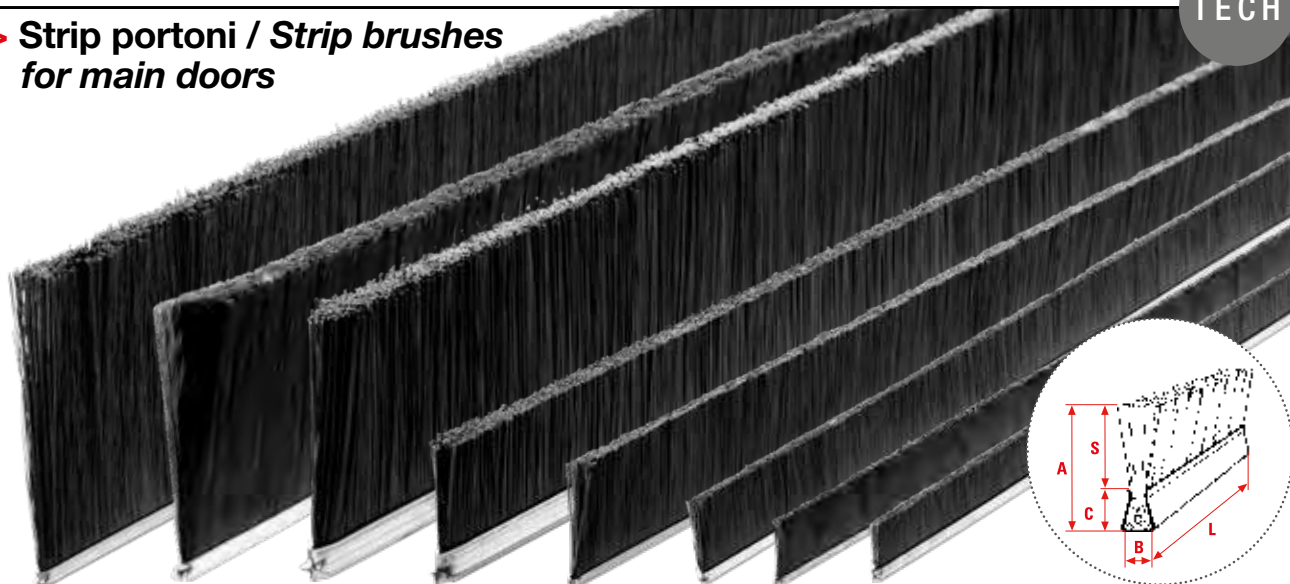

Spazzole lineari Strip con filamento in polipropilene nero liscio (PPI N.L.).

Linear Strip brushes with black straight polypropylene filaments (PPL N.L.).

### Strip portoni / Strip brushes for main doors

Display strip

B		A		C		S		L			0,15mm	0,20mm	0,25mm	0,15-0,20-0,25mm	
mm	inch	mm	inch	mm	inch	mm	inch	mm	inch	m	inch	0,006"	0,008"	0,010"	0,006"-0,008"-0,010"
2,5	3/32	15	9/16	2,5	3/32	12	1/2	2000	78-3/4	100	3937	<b>1215</b>			
2,5	3/32	19	3/4	2,5	3/32	17	5/8	2000	78-3/4	100	3937	<b>1219</b>			
4	5/32	15	9/16	4	5/32	11	7/16	2500	98-3/8	250	9844	<b>1105</b>			<b>0009</b>
4	5/32	19	3/4	4	5/32	15	9/16	2500	98-3/8	250	9844	<b>1106</b>			<b>1099</b>
4	5/32	25	1	4	5/32	21	7/8	2500	98-3/8	125	4922		<b>1107</b>		<b>1127</b>
4	5/32	32	1-1/4	4	5/32	28	1-1/8	2500	98-3/8	125	4922		<b>1108</b>		<b>0024</b>
4	5/32	38	1-1/2	4	5/32	34	1-3/8	2500	98-3/8	125	4922		<b>1210</b>		
5	3/16	20	3/4	5	3/16	15	9/16	2500	98-3/8	125	4922	<b>1211</b>			
5	3/16	25	1	5	3/16	20	3/4	2500	98-3/8	125	4922		<b>1119</b>		<b>0002</b>
5	3/16	32	1-1/4	5	3/16	27	1	2500	98-3/8	125	4922		<b>1120</b>		<b>1128</b>
5	3/16	38	1-1/2	5	3/16	33	1-1/4	2500	98-3/8	125	4922			<b>1121</b>	<b>1138</b>
5	3/16	50	2	5	3/16	45	1-3/4	2500	98-3/8	125	4922			<b>1122</b>	<b>1139</b>
5	3/16	60	2-3/8	5	3/16	55	2-1/8	2500	98-3/8	125	4922			<b>1123</b>	<b>0004</b>
5	3/16	70	2-3/4	5	3/16	65	2-1/2	2500	98-3/8	62,5	2461			<b>1212</b>	
5	3/16	80	3-1/8	5	3/16	75	3	2500	98-3/8	62,5	2461			<b>1124</b>	
5	3/16	90	3-1/2	5	3/16	85	3-3/8	2500	98-3/8	62,5	2461			<b>1125</b>	
5	3/16	100	4	5	3/16	95	3-3/4	2500	98-3/8	62,5	2461			<b>1126</b>	

Unità di vendita = metri / Selling unit = meters

### Strip alta densità / High density strip brushes

B		A		C		S		L			0,50mm	1mm	
mm	inch	mm	inch	mm	inch	mm	inch	mm	inch	m	inch	0,020"	0,040"
8	5/16	40	2-3/4	8	5/16	32	1-1/4	2500	98-3/8	25	984	<b>1166</b>	
8	5/16	50	2	8	5/16	42	1-5/8	2500	98-3/8	25	984	<b>1167</b>	
8	5/16	75	3	8	5/16	67	2-5/8	2500	98-3/8	25	984	<b>1284</b>	
8	5/16	100	4	8	5/16	92	3-5/8	2500	98-3/8	25	984	<b>1285</b>	
8	5/16	120	4-3/4	8	5/16	112	4-3/8	2500	98-3/8	25	984		<b>1286</b>
8	5/16	145	5-3/4	8	5/16	137	5-3/8	2500	98-3/8	25	984		<b>1287</b>

Disponibili referenze con barcode per singolo pezzo / Individually barcode-tagged strips and supports are available.

Unità di vendita = metri / Selling unit = meters

### APPLICAZIONI / APPLICATIONS

Applicati su serramenti e portoni industriali per la tenuta di aria e polvere.

Applied on industrial windows and door frames as a sealing element against air and dust.

Display STRIP:  
Vedi pag. 131 /  
See page 131



> **Guaine / Tapes**

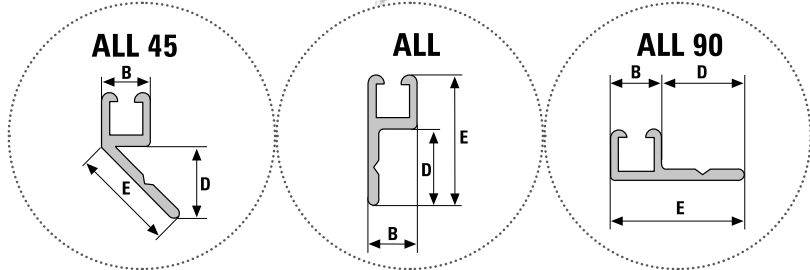
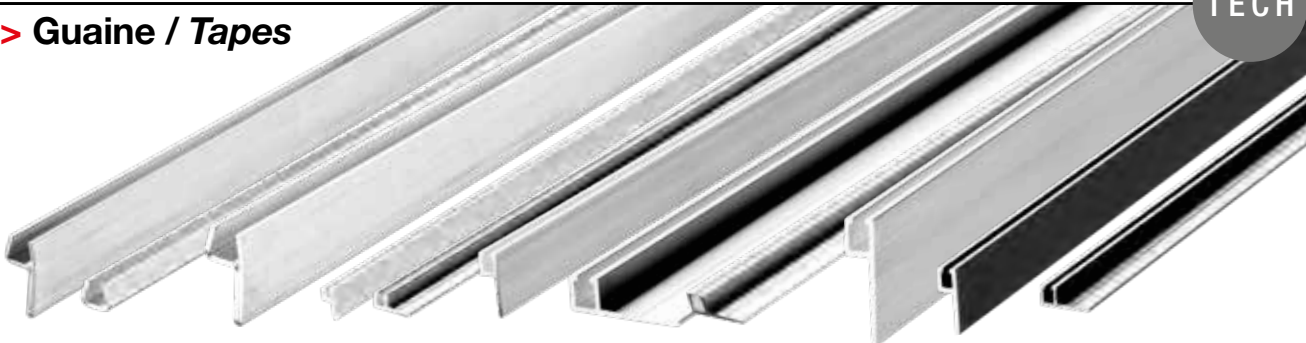

Guaine di supporto semplici o alettate a seconda delle esigenze di montaggio. A richiesta, sono disponibili guaine anodizzate bronzo.

Simple or finned (depending on installation requirements) aluminum tapes. Upon request, bronze anodized profiles are available.

**Guaine in alluminio GA / Aluminum tapes GA**



B strip		B		D		E		L		m		ART	Alluminio Aluminum	Al. nero Black Alu.	Al. Barcode Barcode Alu.
mm	inch	mm	inch	mm	inch	mm	inch	mm	inch	m	inch				
2,5	3/32	5	3/16	7	1/4	12	1/2	2000	78-3/4	100	3937	<b>G-ALL-2,5</b>	<b>1271</b>		
4	5/32	6,5	1/4	11	7/16	17,5	5/8	2500	98-3/8	62,5	2461	<b>G-ALL-4</b>	<b>1255</b>	<b>1248</b>	<b>1218</b>
4	5/32	6,5	1/4	11	7/16	17,5	5/8	2500	98-3/8	62,5	2461	<b>G-ALL90-4</b>	<b>1254</b>	<b>1249</b>	<b>1246</b>
5	3/16	7,1	1/4	14	9/16	22,3	7/8	2500	98-3/8	62,5	2461	<b>G-ALL-5</b>	<b>1261</b>	<b>1263</b>	<b>1247</b>
5	3/16	8,1	5/16	16	5/8	24,8	1	2500	98-3/8	62,5	2461	<b>G-ALL90-5</b>	<b>1262</b>	<b>1264</b>	<b>1277</b>
5	3/16	8,1	5/16	16	5/8	22,3	7/8	2500	98-3/8	62,5	2461	<b>G-ALL45-5</b>	<b>1272</b>		
8	5/16	13,5	17/32	35,5	1-3/8	50	2	2500	98-3/8	25	984	<b>G-ALL-8</b>	<b>1273</b>		
8	5/16	13,5	17/32	36,5	1-7/16	50	2	2500	98-3/8	25	984	<b>G-ALL90-8</b>	<b>1274</b>		

Unità di vendita = metri / Selling unit = meters

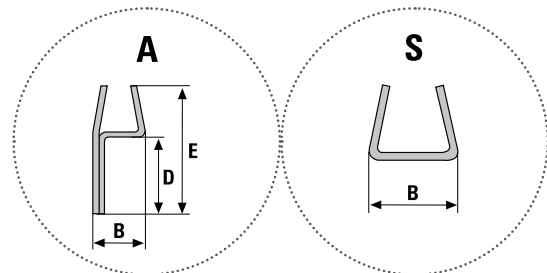

**Guaine in acciaio GL / Steel tapes GL**

B strip		B		D		E		L		m		ART	Acciaio zincato Zinc-plated steel	Inox S-steel
mm	inch	mm	inch	mm	inch	mm	inch	mm	inch	m	inch			
8	5/16	12,9	1/2					1000	39-3/8	30	1181	<b>G-S-8</b>	<b>1265</b>	
8	5/16	14,5	9/16	18,8	3/4	30	1-1/8	1000	39-3/8	30	1181	<b>G-A-8</b>	<b>1266</b>	
10	3/8	14	9/16					1000	39-3/8	30	1181	<b>G-S-10</b>	<b>1267</b>	<b>1276</b>
10	3/8	15,5	5/8	20	3/4	32	1-1/4	1000	39-3/8	30	1181	<b>G-A-10</b>	<b>1268</b>	<b>1275</b>
13	1/2	19,5	3/4					1000	39-3/8	30	1181	<b>G-S-13</b>	<b>1269</b>	
13	1/2	19,5	3/4	25	1	40	1-5/8	1000	39-3/8	30	1181	<b>G-A-13</b>	<b>1270</b>	
13	1/2	19,5	3/4	45	1-3/4	60	2-3/8	1000	39-3/8	30	1181	<b>G-A-13</b>	<b>1278</b>	

Unità di vendita = pezzi / Selling unit = pieces



Tutti gli articoli in assortimento con l'espositore STRIP sono etichettati con descrizione articolo e barcode.

All items sold with the display STRIP are individually labeled with their item description and barcode.





# STRIP



## > Strip industriali / Industrial strip brushes

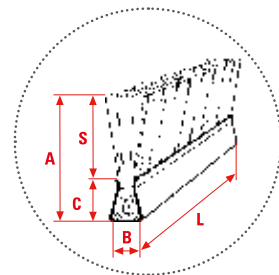
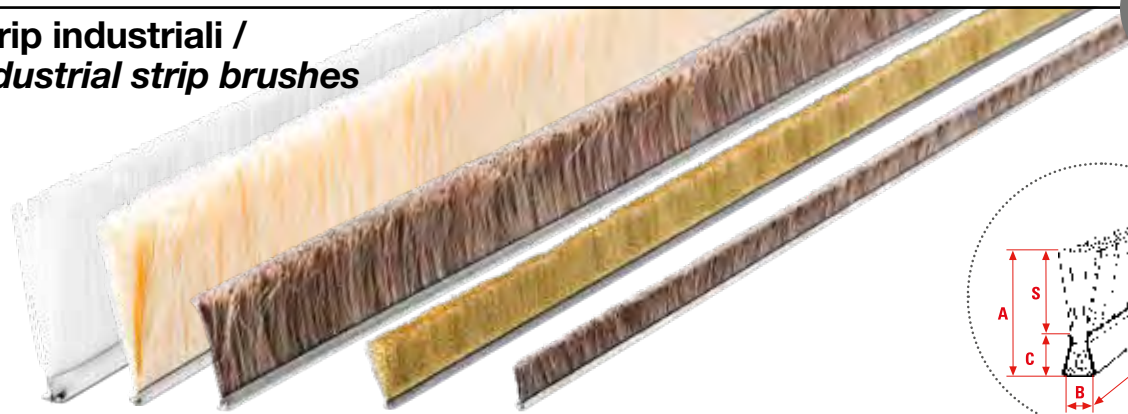

Strip lineari disponibili con svariati tipi di filamento.  
Linear strip brushes available with different kind of wires.

### Strip industriali B = 4→5mm - 5/32"→3/16" / Industrial strip brushes B = 4→5mm - 5/32"→3/16"

B		A		C		S		L		Filo / Wire	m		Ref
mm	inch	mm	inch	mm	inch	mm	inch	mm	inch		m	inch	
4	5/32	17	5/8	4	5/32	13	1/2	2500	98-3/8	PPL B.L. 0,20mm/0,008"	30	1181	1220
4	5/32	20	3/4	4	5/32	16	5/8	2500	98-3/8	CRINE GRIGIO	30	1181	1221
4	5/32	25	1	4	5/32	21	7/8	2500	98-3/8	OTTONE OND. 0,10mm/0,004"	30	1181	1222
5	3/16	20	3/4	5	3/16	15	5/8	2500	98-3/8	NYL B.L. 0,30mm/0,012"	30	1181	1227
5 inox	3/16	25	1	5	3/16	20	3/4	2500	98-3/8	INOX 0,15mm/0,006"	30	1181	1240
5	3/16	30	1-1/8	5	3/16	25	1	2500	98-3/8	CRINE GRIGIO	30	1181	1223
5	3/16	30	1-1/8	5	3/16	25	1	2500	98-3/8	ACC. OND. 0,20mm/0,008"	30	1181	1241
5	3/16	35	1-3/8	5	3/16	30	1-1/8	2500	98-3/8	NYL B.L. 0,30mm/0,012"	30	1181	1228
5	3/16	35	1-3/8	5	3/16	30	1-1/8	2500	98-3/8	PPL B.O. 0,35mm/0,014"	30	1181	1229
5	3/16	35	1-3/8	5	3/16	30	1-1/8	2500	98-3/8	TAMPICO	30	1181	1225
5	3/16	35	1-3/8	5	3/16	30	1-1/8	2500	98-3/8	OTTONE OND. 0,15mm/0,006"	30	1181	1242
5	3/16	40	1-5/8	5	3/16	35	1-3/8	2500	98-3/8	NYL N.Z. 0,30mm/0,012"	30	1181	1231
5 inox	3/16	40	1-5/8	5	3/16	35	1-3/8	2500	98-3/8	PPL N.L. 0,20mm/0,008"	125	4922	1230
5	3/16	40	1-5/8	5	3/16	35	1-3/8	2500	98-3/8	CRINE GRIGIO	30	1181	1290
5	3/16	40	1-5/8	5	3/16	35	1-3/8	2500	98-3/8	INOX OND. 0,15mm/0,006"	30	1181	1243
5 inox	3/16	45	1-3/4	5	3/16	40	1-5/8	2500	98-3/8	INOX 0,20mm/0,008"	30	1181	1244
5	3/16	50	2	5	3/16	45	1-3/4	2500	98-3/8	NYL B.L. 0,30mm/0,012"	30	1181	1232
5 inox	3/16	60	2-3/8	5	3/16	55	2-1/8	2500	98-3/8	PPL N.L. 0,20mm/0,008"	125	4922	1233
5	3/16	60	2-3/8	5	3/16	55	2-1/8	2500	98-3/8	NYL N.Z. 0,30mm/0,012"	30	1181	1234
5	3/16	60	2-3/8	5	3/16	55	2-1/8	2500	98-3/8	CRINE GRIGIO	30	1181	1224
5	3/16	60	2-3/8	5	3/16	55	2-1/8	2500	98-3/8	ACC. OND. 0,20mm/0,008"	30	1181	1245
5	3/16	70	2-3/4	5	3/16	65	2-1/2	2500	98-3/8	NYL B.L. 0,30mm/0,012"	30	1181	1235
5	3/16	70	2-3/4	5	3/16	65	2-1/2	2500	98-3/8	PPL B.O. 0,35mm/0,014"	30	1181	1236
5	3/16	70	2-3/4	5	3/16	65	2-1/2	2500	98-3/8	NYL B.L. 0,40mm/0,016"	30	1181	1237
5	3/16	70	2-3/4	5	3/16	65	2-1/2	2500	98-3/8	NYL B.L. 0,60mm/0,024	30	1181	1238
5	3/16	70	2-3/4	5	3/16	65	2-1/2	2500	98-3/8	TAMPICO	30	1181	1226
5	3/16	88	3-1/2	5	3/16	83	3-1/4	2500	98-3/8	PPL N.L. 0,50mm/ 0,020"	30	1181	1239

Unità di vendita = metri / Selling unit = meters



> **Strip industriali / Industrial strip brushes**

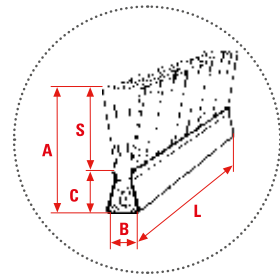
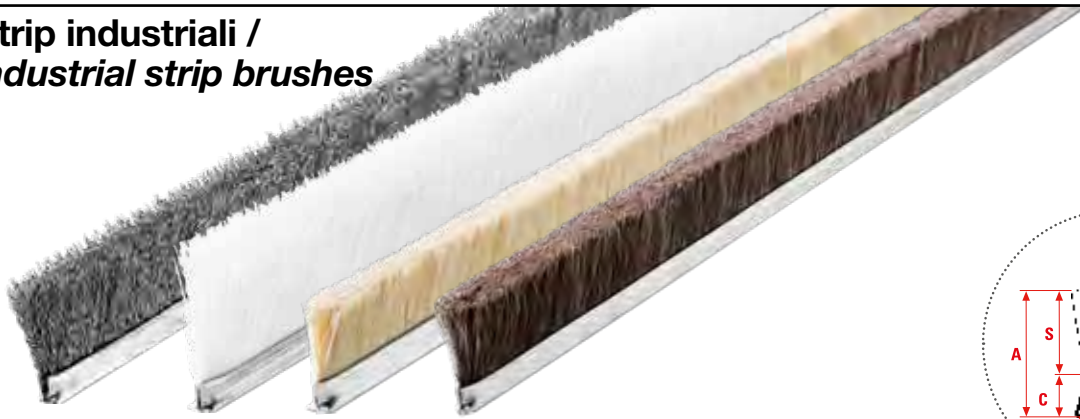

Strip lineari disponibili con svariati tipi di filamento.  
Linear strip brushes available with different kind of wires.

**Strip industriali B = 8→10mm - 5/16"→3/8" / Industrial strip brushes B = 8→10mm - 5/16"→3/8"**

B		A		C		S		L		Filo / Wire	m		Ref
mm	inch	mm	inch	mm	inch	mm	inch	mm	inch		m	inch	
8	5/16	80	3-1/8	8	5/16	72	2-7/8	2500	98-3/8	NYL B.L. 0,30mm/0,012"	30	1181	<b>1168</b>
10	3/8	40	1-5/8	10	3/8	30	1-1/8	2000	78-3/4	PPL B.L. 0,30mm/0,012"	30	1181	<b>1171</b>
10	3/8	40	1-5/8	10	3/8	30	1-1/8	2000	78-3/4	TAMPICO	30	1181	<b>1169</b>
10	3/8	50	2	10	3/8	40	1-5/8	2000	78-3/4	PPL B.L. 0,30mm/0,012"	30	1181	<b>1172</b>
10	3/8	50	2	10	3/8	40	1-5/8	2000	78-3/4	NYL B.L. 0,60mm/0,024"	30	1181	<b>1173</b>
10	3/8	50	2	10	3/8	40	1-5/8	2000	78-3/4	CRINE	30	1181	<b>1170</b>
10	3/8	50	2	10	3/8	40	1-5/8	2000	78-3/4	ACC. 0,35mm/0,014"	30	1181	<b>1194</b>
10	3/8	60	2-3/8	10	3/8	50	2	2000	78-3/4	PPL B.L. 0,30mm/0,012"	30	1181	<b>1174</b>
10 inox	3/8	60	2-3/8	11	7/16	49	1-7/8	2000	78-3/4	PPL B.L. 0,40mm/0,015"	30	1181	<b>1175</b>
10	3/8	60	2-3/8	10	3/8	50	2	2500	98-3/8	PPL B.O. 0,60mm/0,024"	30	1181	<b>1176</b>
10 inox	3/8	60	2-3/8	11	7/16	49	2	2000	78-3/4	INOX 0,20mm/0,008"	30	1181	<b>1195</b>
10	3/8	70	2-3/4	10	3/8	60	2-3/8	2000	78-3/4	PPL B.L. 0,60mm/0,024"	30	1181	<b>1178</b>
10	3/8	70	2-3/4	10	3/8	60	2-3/8	2000	78-3/4	PPL B.L. 1,1mm/0,043"	30	1181	<b>1179</b>
10	3/8	80	3-1/8	10	3/8	70	2-3/4	2000	78-3/4	PPL B.L. 0,80mm/0,030"	30	1181	<b>1181</b>
10	3/8	80	3-1/8	10	3/8	70	2-3/4	2000	78-3/4	NYL B.L. 0,40mm/0,015"	30	1181	<b>1180</b>
10	3/8	80	3-1/8	10	3/8	70	2-3/4	2000	78-3/4	ACC. 0,35mm/0,014"	30	1181	<b>1196</b>
10	3/8	90	3-1/2	10	3/8	80	3-1/8	2000	78-3/4	PPL B.L. 0,60mm/0,024"	30	1181	<b>1182</b>
10	3/8	100	4	10	3/8	90	3-1/2	2000	78-3/4	PPL B.L. 0,80mm/0,030"	30	1181	<b>1183</b>
10	3/8	100	4	10	3/8	90	3-1/2	2000	78-3/4	PPL B.L. 1,2x1,6	30	1181	<b>1184</b>
10	3/8	110	4-3/8	10	3/8	100	4	2000	78-3/4	PPL B.L. 0,60mm/0,024"	20	1181	<b>1185</b>
10 inox	3/8	110	4-3/8	11	7/16	99	3-7/8	2000	78-3/4	PPL B.L. 1,1mm/0,043"	20	1181	<b>1186</b>
10	3/8	120	4-3/4	10	3/8	110	4-3/8	2000	78-3/4	PPL B.L. 0,60mm/0,024"	30	1181	<b>1187</b>
10	3/8	128	5	10	3/8	118	4-5/8	3000	118-1/8	PPL B.L. 0,80mm/0,030"	30	1181	<b>1188</b>
10	3/8	140	5-1/2	10	3/8	130	5-1/8	2000	78-3/4	PPL B.L. 0,80mm/0,030"	30	1181	<b>1189</b>
10	3/8	160	6-1/4	10	3/8	150	6	2000	78-3/4	NYL B.L. 0,80mm/0,030"	30	1181	<b>1190</b>
10	3/8	180	7-1/8	10	3/8	170	6-3/4	2000	78-3/4	PPL B.L. 0,80mm/0,030"	30	1181	<b>1191</b>
10	3/8	195	7-5/8	10	3/8	185	7-1/4	2000	78-3/4	NYL B.L. 1mm/0,040"	30	1181	<b>1192</b>
10	3/8	250	10	10	3/8	240	9-9/16	2000	78-3/4	PPL B.L. 1,1mm/0,043"	20	1181	<b>1193</b>

Unità di vendita = metri / Selling unit = meters



GUARDA IL VIDEO  
WATCH THE VIDEO

sitbrush.tv/s1





# STRIP

TECH

## > Strip industriali / Industrial strip brushes

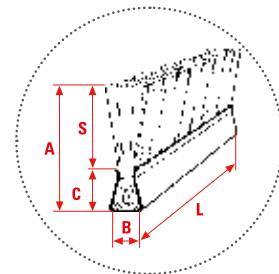
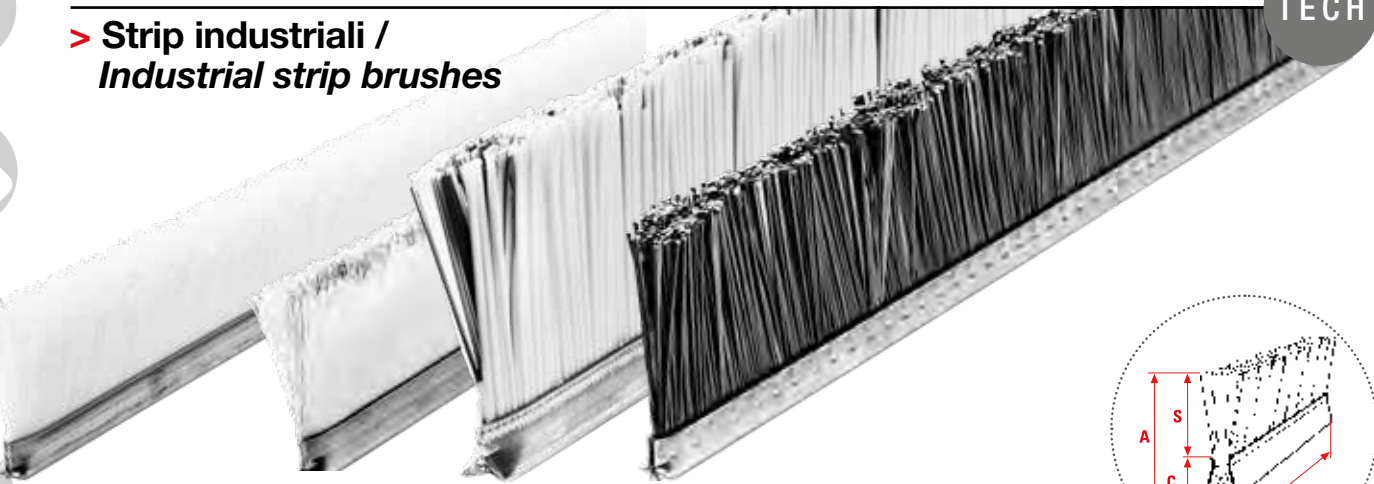

Strip lineari disponibili con svariati tipi di filamento.  
Linear strip brushes available with different kinds of filament.

### Strip industriali B = 13→14mm - 1/2" → 9/16" / Industrial strip brushes B = 13→14mm - 1/2" → 9/16"

B		A		C		S		L		Filo / Wire	m		Ref
mm	inch	mm	inch	mm	inch	mm	inch	mm	inch		m	inch	
13	1/2	70	2-3/4	18	3/4	52	2	2000	78-3/4	<b>PPL B.O. 0,80mm/0,030"+ACC. 0,50mm/0,020"</b>	30	1181	<b>1198</b>
13	1/2	70	2-3/4	18	3/4	52	2	2000	78-3/4	<b>ACC. 0,50mm/0,020"</b>	30	1181	<b>1199</b>
13	1/2	80	3-1/8	18	3/4	62	2-1/2	2000	78-3/4	<b>PPL B.O. 0,80mm/0,030"</b>	30	1181	<b>1197</b>
13	1/2	90	3-1/2	18	3/4	72	2-7/8	2000	78-3/4	<b>ACC. 0,40mm/0,015"</b>	30	1181	<b>1200</b>
13	1/2	100	4	18	3/4	82	3-1/4	2000	78-3/4	<b>ACC. 0,50mm/0,020"</b>	30	1181	<b>1201</b>
14	9/16	70	2-3/4	15	9/16	55	2-1/8	2500	98-3/8	<b>PPL B.O. 0,80mm/0,030"</b>	30	1181	<b>1202</b>

Unità di vendita = metri / Selling unit = meters

### Strip per blocchiere / Strip brushes for block machines

B		A		C		S		L		Filo / Wire	pezzi		Ref
mm	inch	mm	inch	mm	inch	mm	inch	mm	inch				
13	1/2	100	4	18	3/4	82	3-1/4	1280	50-3/8	<b>NYL N.L. 1,5+PIAT.ACC. 1,1x0,25</b>	1/10	pz	<b>1204</b>
19	3/4	115	4-1/2	25	1	90	3-1/2	1300	51-1/8	<b>PPL B.L. 2x3+PIAT.ACC. 1,1x0,25</b>	1/10	pz	<b>1205</b>

Unità di vendita = pezzi / Selling unit = pieces

Su richiesta sono disponibili filamenti sintetici resistenti ad alte temperature (fino a 250°C - 482°F), conduttori o certificati per uso alimentare.  
On request, high temperature resistant synthetic filaments (up to 250°C - 482°F), electrical conductors synthetic filaments, certified synthetic filaments for food industry, are available.

### APPLICAZIONI / APPLICATIONS

Protezione da polvere, umidità e aria; pulizia e spazzolatura di componenti che transitano all'interno di macchinari; pulizia di componenti in movimento (rulli, cinghie e nastri trasportatori).

Protection from dust, moisture and air; cleaning of components while they are moving into machinery; cleaning of moving parts (rollers, belts and conveyor belts).

GUARDA IL VIDEO  
WATCH THE VIDEO



sitbrush.tv/s1



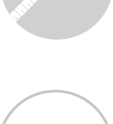
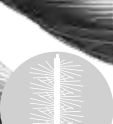

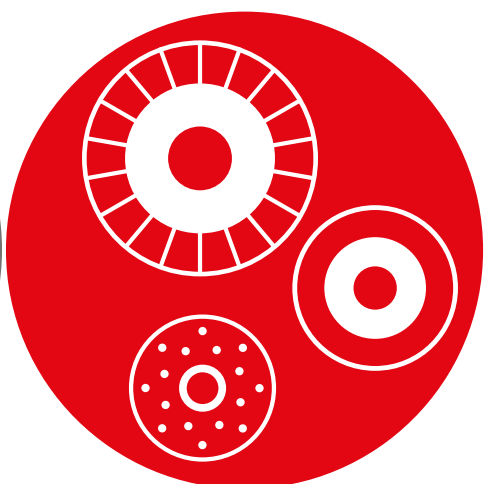
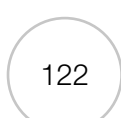
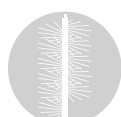

**VARIE  
VARIOUS**

**VARIE / VARIOUS**



> **Spazzole coniche per decespugliatore**  
*Bevel brushes for string trimmer*

p. 123



> **Scope e Laminoscope**  
*Brooms and Sweepers*

p. 124



> **Salvagronda**  
*Gutter saver*

p. 125



> **Dischi**  
*Discs*

p. 126



> **Moduli punzonati**  
*Staple set modular brushes*

p. 129



> **Spazzole Composite a disco**  
*Composite disc brushes*

p. 130



**> Spazzole coniche per decespugliatore / Bevel brushes for string trimmer**

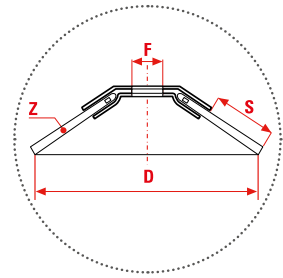

**NEW**

Le spazzole coniche per utilizzo su decespugliatore sono una scelta sicura\*, efficace e anche ecologica in quanto alternative a diserbanti chimici spesso vietati dalla legge di molti paesi.

*Bevel brushes for string trimmers - grass trimmers are safe\*, very effective and ecologically friendly since they substitute chemical herbicides often forbidden by the law in many countries.*

**Coniche per decespugliatore / Bevel brushes for string trimmer**

D		F**		S		Z	MAX RPM	Box 2	ART	Acciaio/Steel	LIZ	Nylon
mm	inch	mm	inch	mm	inch					0,50mm/0,020"	0,25mm/0,010"	1,5mm/0,060"
170	6-3/4	25,4	1	50	2		10000	1/8	<b>C0170</b>			<b>0298</b>
170	6-3/4	25,4	1	50	2	32	10000	1/8	<b>CZ170</b>	<b>0317</b>	<b>0321</b>	
200	8	25,4	1	38	1-1/2	36	10000	1/8	<b>CZ200</b>	<b>0319</b>		

È consigliabile una potenza di decespugliatore pari o superiore a 1,6 cavalli (25cc - 1,53 cu. in.)  
Recommended string trimmer motor size: 1,6 HP or more (25cc - 1,53 cu. in.)

\*\* Fornito adattatore metallico a foro 20mm - 3/4"  
Supplied with metal adapter to 20mm - 3/4" bore

\* Leggere e rispettare le istruzioni di sicurezza fornite insieme alla spazzola ed all'elettrotensile prima di utilizzare le spazzole per decespugliatore/ Read and respect safety instructions provided together with the brush and with the power tool when using brushes on grass trimmers

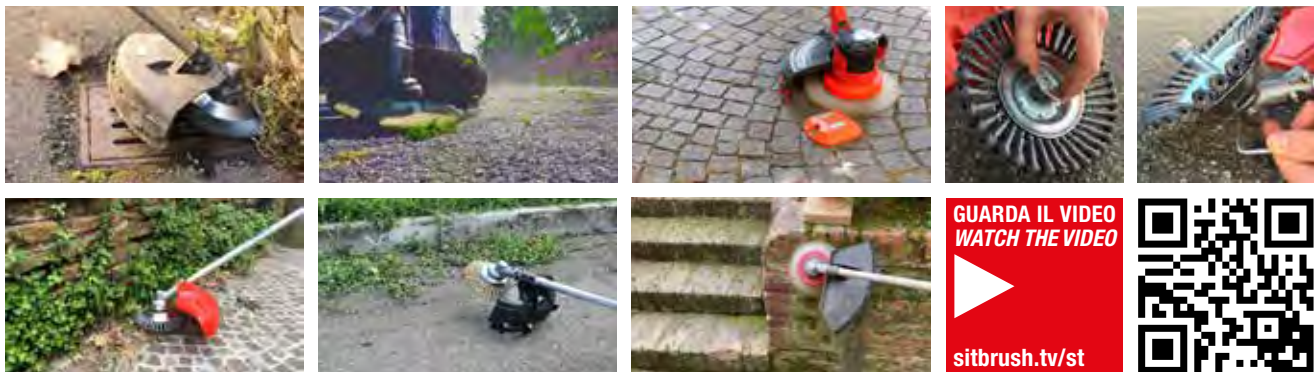

**GUARDA IL VIDEO  
WATCH THE VIDEO**  
[sitbrush.tv/st](http://sitbrush.tv/st)



**APPLICAZIONI / APPLICATIONS**

Rimuovere facilmente e rapidamente erbacce, arbusti e vegetazione incontrollata da strade, pavimenti e marciapiedi di qualsiasi genere (asfalto, ciotoli, ...) anche in ampi spazi (cortili, parcheggi, ...)  
*Remove easily and quickly weeds, shrubbery on streets, walkways, grass pavers, curbstones, cobbled areas and hard to reach corners, even in wide floors like courtyards, parkings, ...*

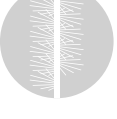



## VARIE / VARIOUS

### > Scope e Laminoscope / Brooms and Sweepers



LLW6 Acciaio/Steel

LLW6 PVC

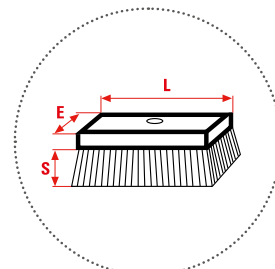

Scope disponibili in diversi filamenti: PPL, PVC e acciaio. Il supporto metallico rende le laminoscope più resistenti. Per montaggio su manici standard con diametro 25mm - 1".

Brooms and sweepers available in different strands: PPL, PVC and steel. The metallic support makes sweepers more resistant. For mounting on standard handles/sticks with diameter of 25mm - 1".

### Scope / Brooms

L		E		S		Filo / Filament		ART	Ref
mm	inch	mm	inch	mm	inch				
300	12	70	2-3/4	70	2-3/4	Acciaio / Steel	12	W1	1839
310	12-1/4	70	2-3/4	110	4-3/8	PPL	12	W3	1833

### Laminoscope / Sweepers

L		E		S			ART	0,56mm	0,75mm
mm	inch	mm	inch	mm	inch			0,022"	0,030"
380	15	25	1	70	2-3/4	1	LLW4	1824	
580	22-7/8	25	1	70	2-3/4	1	LLW6	1832	1831
900	35-1/2	25	1	70	2-3/4	1	LLW9		1837

TECH



GUARDA IL VIDEO  
WATCH THE VIDEO



### APPLICAZIONI / APPLICATIONS

Pulizia di grandi superfici. Le laminoscope sono ideali per pulizie più gravose e ripetitive, durante le quali il manico ed il supporto vengono messi a dura prova dallo sforzo di torsione e pressione.

Cleaning of wide indoor (workshop, production floor, ...) and outdoor (walkways, asphalt, ...) surfaces. Sweepers are ideal for harder and repetitive cleaning operations, during which the handle and the support are severely tested by torsion and pressure.

> Salvagronda / Gutter saver

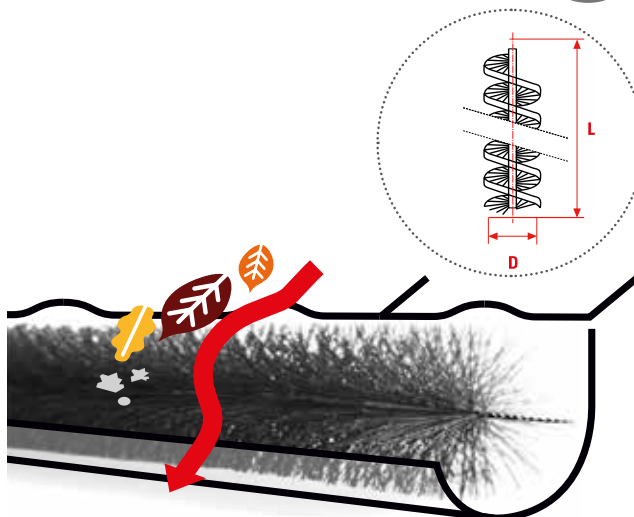

Spazzola a spirale flessibile, in PPL, lunga 3m e "modulare". Salvagronda è un prodotto originale SIT Tecnospaazzole che in maniera facile e geniale permette di proteggere qualsiasi grondaia e canalizzazione dall'intasamento causato da foglie, rami secchi e detriti. Una volta inserita manualmente nella grondaia o nello scolo, Salvagronda fa il suo dovere in completa autonomia! Consigliamo una manutenzione semplice e regolare togliendo la spazzola quando è molto sporca, lavandola sotto un getto d'acqua e riposizionandola come prima, così ha durata quasi infinita!

Flexible spiral brush, made of PPL, 3m-118" long and modular. The gutter saver is an original product by SIT Tecnospaazzole that, in a simple yet brilliant way, prevents leaves, branches and other waste from settling inside gutters or pipes. Once manually placed inside the gutter or the drain, the save gutter works in complete autonomy. We suggest a simple and regular maintenance by removing the brush when it is dirty, washing it under running water and repositioning it as before, this way it almost has a never ending life!

Salvagronda / Gutter saver

D		L		2	ART	0,80mm
mm	inch	mm	inch			0,031"
100	4	3000	118	9	Salvagronda 100	1841
100	4	3000	118	1/6	Salvagronda 100	1974
120	4-3/4	3000	118	5	Salvagronda 120	1844
120	4-3/4	3000	118	1/4	Salvagronda 120	1975
150	6	3000	118	4	Salvagronda 150	1819
<b>Display</b>						<b>1843</b>



Add-on espositore Salvagronda / Add-on Salvagronda for display  
Cod.: 06006128



GUARDA IL VIDEO  
WATCH THE VIDEO

sitbrush.tv/  
salvagronda



GUARDA IL VIDEO  
WATCH THE VIDEO

sitbrush.tv/  
salvagronda2



APPLICAZIONI / APPLICATIONS

Protezione di grondaie e canalizzazioni. Può essere usato per prevenire la crescita di erbacce negli scarichi a terra.  
Gutter and canalization protection. It can be used to prevent the growth of bushes in ground drains.





# VARIE / VARIOUS

## > Dischi / Discs

DL125



DLC115



DL115

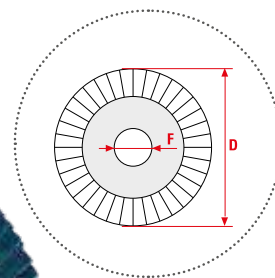

**DL Top** Dischi Lamellari di primissima qualità, con lamella doppia o singola e foro 22mm - 7/8". Supporto piano o conico, in nylon o in fibra di vetro.

**DLM Extra** Dischi Lamellari Extra: Doppia durata e altissima capacità di asportazione con riduzione tempi di lavoro e miglior rapporto qualità prezzo.

**DLC Ceramic** Dischi Lamellari Ceramici: Dischi TECH di tela abrasiva con rivestimento specifico per trattamento acciaio inox. Altissima velocità di taglio e durata del disco. Riduce sensibilmente il surriscaldamento del pezzo da lavorare e del disco.

**DL Top** Top quality flap discs, with double or single flap and 22mm - 7/8" bore. Flat or conical, Nylon or fibreglass support.

**DLM Extra** Extra Flap Discs: Double durability and extremely high grinding ability, reducing processing time, and better price/quality ratio.

**DLC Ceramic** Flap Discs: TECH abrasive flap discs with specific coating for treating stainless steel. Extremely high cutting speed and disc service life. Significantly reduces overheating of the workpiece and disc.

### Dischi lamellari DL Zirconio - TOP / DL Zirconium Flap Discs - TOP

D		Supporto / Support	Lamelle / Flap		MAX RPM		ART				
mm	inch		N°	Tipo / Type				40gr	60gr	80gr	120gr
115	4-1/2	Nylon, piano / Flat Nylon	72	Doppia / Double	13300	10/80	<b>DL115</b>	<b>0454</b>	<b>0455</b>	<b>0456</b>	
115	4-1/2	Fibra, conico / Conical fiber	72	Singola / Single	13300	10/80	<b>DL115</b>	<b>0466</b>	<b>0467</b>	<b>0468</b>	<b>0492</b>
125	5	Fibra, piano / Flat fiber	80	Singola / Single	12200	10/80	<b>DL125</b>	<b>0493</b>	<b>0494</b>	<b>0495</b>	<b>0496</b>
125	5	Fibra, conico / Conical fiber	80	Singola / Single	12200	10/80	<b>DL125</b>	<b>0486</b>	<b>0487</b>	<b>0488</b>	

### Dischi Lamellari Extra DLM - EXTRA / Extra DLM Flap Discs - EXTRA

D		Supporto / Support	Lamelle / Flap		MAX RPM		ART		
mm	inch		N°	Tipo / Type				40gr	60gr
115	4-1/2	Fibra, piano / Flat fiber	80	Singola / Single	13300	10/80	<b>DL115 Extra</b>	<b>0497</b>	<b>0498</b>

TECH

NEW

### Dischi Lamellari Zirconio Ceramico DLC - CERAMIC Ceramic Zirconium Flap Discs DLC - CERAMIC

D		Supporto / Support	Lamelle / Flap		MAX RPM		ART		
mm	inch		N°	Tipo / Type				40gr	60gr
115	4-1/2	Fibra, piano / Flat fiber	72	Singola / Single	13300	10/80	<b>DLC115</b>	<b>0499</b>	<b>0490</b>

TECH

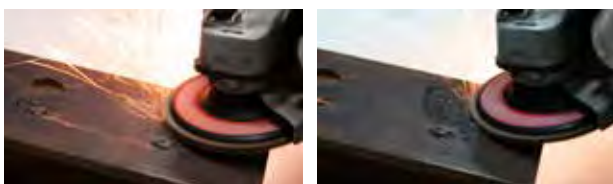

#### APPLICAZIONI / APPLICATIONS

Finitura delle superfici; pulizia saldature in acciaio Inox; rimozione ossidi e vernici.  
Surface finishing, stainless steel weld cleaning; oxides and paint removal.



GUARDA IL VIDEO  
WATCH THE VIDEO  
  
sitbrush.tv/v2



**> Dischi / Discs**

**DT230**



**DT230**



**DS 115**

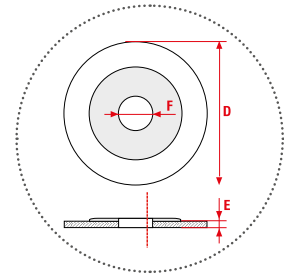

**DT** Dischi da taglio in ossido d'alluminio o in carburo di silicio.  
**DS** Dischi da sbavatura in ossido d'alluminio.

**DT** Cutting discs made of aluminium oxide or silicon carbide.  
**DS** Deburring discs in aluminium oxide.

**Dischi da taglio / Cutting discs**

D		E		F		MAX RPM		ART	Per Inox* For Inox*	Per ferro For iron	Per alluminio For Aluminum	Per marmo For marble
mm	inch	mm	inch	mm	inch							
115	4-1/2	1	3/64	22	7/8	13300	10/80	<b>DT115</b>	<b>1749</b>			
115	4-1/2	1,6	1/16	22	7/8	13300	10/80	<b>DT115</b>	<b>1750</b>		<b>1743</b>	<b>1747</b>
115	4-1/2	3,2	1/8	22	7/8	13300	10/80	<b>DT115</b>		<b>1751</b>		<b>1752</b>
125	5	1	3/64	22	7/8	13000	10/80	<b>DT125</b>		<b>1745</b>		
125	5	1,6	1/16	22	7/8	13000	10/80	<b>DT125</b>		<b>1746</b>		
230	9	2	5/64	22	7/8	13300	10	<b>DT230</b>		<b>1757</b>		
230	9	3,2	1/8	22	7/8	13300	10	<b>DT230</b>		<b>1754</b>		

**Dischi da sbavatura / Deburring discs**

115	4-1/2	6,4	1/4	22	7/8	13300	10/80	<b>DS115</b>		<b>1753</b>	<b>1744</b>	
230	9	6,4	1/4	22	7/8	13300	10	<b>DS230</b>		<b>1756</b>		

\* I dischi da taglio INOX sono eccellenti per tutti i materiali ferrosi. / Stainless steel disks are excellent for all ferrous materials.

**APPLICAZIONI / APPLICATIONS**

**DT** Taglio di acciaio, ferro, alluminio e marmo.  
**DS** Sbavatura ferro.  
**DT** Steel, iron, aluminium and marble cutting.  
**DS** Iron deburring.





**VARIE**

**> Dischi / Discs**

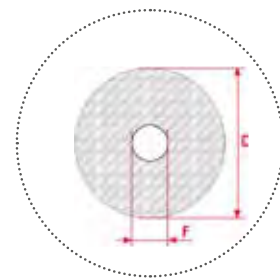
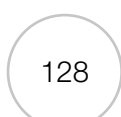
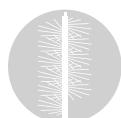

**DN 115**

**RN 150**

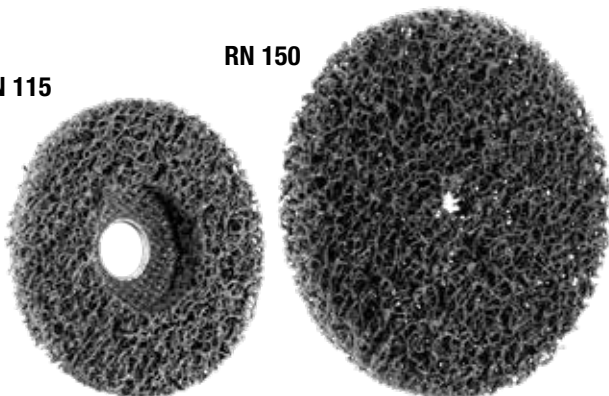

**DN, RN** Dischi in fibra di Nylon molto resistenti, con incorporato abrasivo al carburo di silicio in grana grossa. La struttura fibrosa permette un'azione aggressiva di rimozione del rivestimento senza danneggiare il materiale sottostante. Montabili su smerigliatrice e mini-smerigliatrice (versione DN) o su trapano (versione RN) con apposito gambo.

**DN, RN** Highly resistant Nylon web discs with abrasive silicon carbide in coarse grain. Non-woven material aggressively removes coating without damaging the base material. Mountable on grinder and mini-grinder (DN version) or on drill (version RN) with a specific shank.

**Dischi per decapaggio / Clean and Strip Discs**

D		F		MAX RPM		ART	Ref
mm	inch	mm	inch				
115	4-1/2	22	7/8	11000	5/40	<b>DN115</b>	<b>0433**</b>
100	4	10	3/8	8000	10/80	<b>RN100</b>	<b>0442</b>
150	6	12	1/2	5350	10/40	<b>RN150</b>	<b>0443</b>

\*\* supporto in fibra di vetro / fiberglass support.

Descrizione / Description		ART	Ref
Gambo 6x18mm - 1/4x3/4" con attacco M10 per RN100 Shank 6x18mm - 1/4x3/4" with M10 thread for RN100	10/120	<b>G10</b>	<b>0448</b>
Gambo 8x18mm - 5/16x3/4" con attacco M12 per RN150-200 Shank 8x18mm - 5/16x3/4" with M12 thread for RN150-200	12/144	<b>G12</b>	<b>0449</b>



**APPLICAZIONI / APPLICATIONS**

**DN, RN** Decapaggio, pulizia saldature e rimozione di ruggine e calamina. Ideali su superfici in inox, superfici da stucco, gomma, materie plastiche e molto altro.

**DN, RN** Pickling, weld cleaning, rust and calamine removal. Ideal on stainless steel surfaces, plastered surfaces, rubber, plastics and more.

**> Moduli punzonati / Staple set modular brushes**

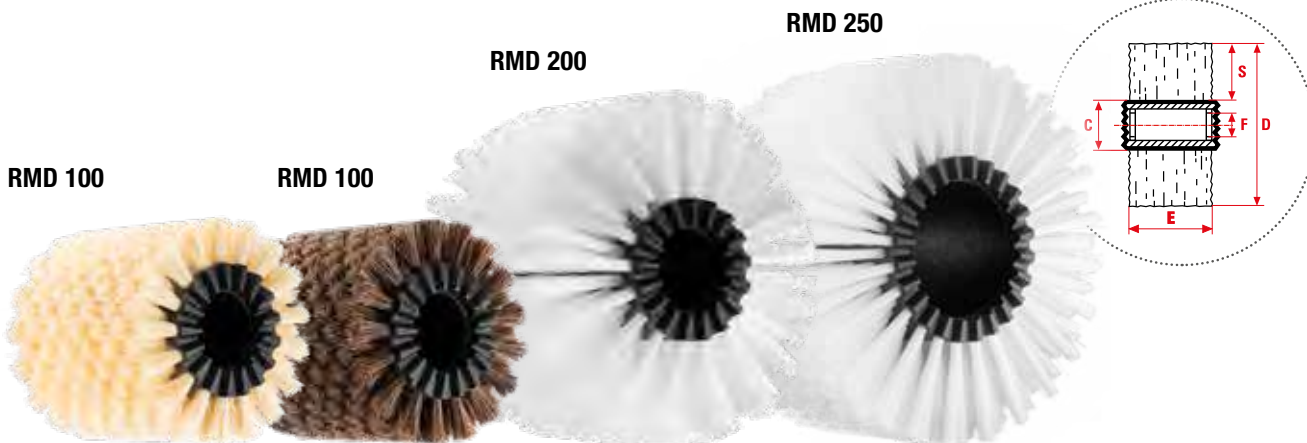

Spazzole cilindriche punzonate modulari di lunghezza standard 100mm - 4" e passo 15mm - 5/8", dentate ai lati per formare rotoli di qualsiasi lunghezza. Gli RMD sono autotrainanti grazie ai collarini TD dotati di 3 grani ciascuno e posti all'estremità del rullo.

Cylindrical Staple set modular brushes: standard length 100mm - 4", pitch 15mm - 5/8", toothed on the sides, suited to form rolls of any length. RMD brushes are self-dragging thanks to the locking collars with three locking screws each, located at the ends of the roller.

**Moduli punzonati RMD / Staple set modular brushes RMD**

D		C		F		S		Denti Teeth	Filo / Wire		ART	Ref
mm	inch	mm	inch	mm	inch	mm	inch					
100	4	60	2-3/8	30	1-1/8	20	3/4	17	PPL BL 0,25mm/0,010"	1	RMD 100/30	1080
100	4	60	2-3/8	30	1-1/8	20	3/4	17	CRINE	1	RMD 100/30	1081
150	6	60	2-3/8	30	1-1/8	45	1-3/4	17	PPL BL 0,35mm/0,014"	1	RMD 150/30	1083
150	6	60	2-3/8	30	1-1/8	45	1-3/4	17	NYLON NL 0,50mm/0,020"	1	RMD 150/30	1084
150	6	60	2-3/8	30	1-1/8	45	1-3/4	17	CRINE	1	RMD 150/30	1085
150	6	60	2-3/8	30	1-1/8	45	1-3/4	17	TAMPICO	1	RMD 150/30	1086
180	7-1/8	85	3-3/8	50	2	47	1-7/8	20	PPL BL 0,45mm/0,018"	1	RMD 180/50	2905
180	7-1/8	85	3-3/8	50	2	47	1-7/8	20	NYLON BL 0,80mm/0,031"	1	RMD 180/50	2906
180	7-1/8	85	3-3/8	50	2	47	1-7/8	20	CRINE	1	RMD 180/50	2907
200	8	95	3-3/4	60	2-3/8	52	2	24	PPL BL 0,35mm/0,014"	1	RMD 200/60	1087
200	8	95	3-3/4	60	2-3/8	52	2	24	NYLON NL 0,50mm/0,0202	1	RMD 200/60	1088
200	8	95	3-3/4	60	2-3/8	52	2	24	NYLON BL 0,80mm/0,031"	1	RMD 200/60	1089
200	8	95	3-3/4	60	2-3/8	52	2	24	CRINE	1	RMD 200/60	1090
200	8	95	3-3/4	60	2-3/8	52	2	24	TAMPICO	1	RMD 200/60	1091
250	10	95	3-3/4	60	2-3/8	77	3	24	PPL BL 0,45/0,018"	1	RMD 250/60	1092
250	10	95	3-3/4	60	2-3/8	77	3	24	PPL BL 0,80mm/0,031"	1	RMD 250/60	1093
250	10	95	3-3/4	60	2-3/8	77	3	24	CRINE	1	RMD 250/60	1094
250	10	95	3-3/4	60	2-3/8	77	3	24	TAMPICO	1	RMD 250/60	1095

Ogni modulo RMD comprende un adattatore TD. / Any RMD modular brush includes a TD adapter.

**Accessori / Accessories**

C		F		E		Descrizione / Description		ART	Ref
mm	inch	mm	inch	mm	inch				
60	2-3/8	30	1-1/8	25	1	<b>Terminale con grani di fissaggio / Locking collar with locking screws</b>	1	TD 30	1077
85	3-3/8	50	2	25	1		1	TD 50	2930
95	3-3/4	60	2-3/8	25	1		1	TD 60	1078



**APPLICAZIONI / APPLICATIONS**

Per leggeri lavori di pulizia, sbavatura, lucidatura, levigatura e satinatura.  
Light cleaning, deburring, polishing, sanding and satin-finishing operations.

**VELOCITÀ PERIFERICA MASSIMA  
MAXIMUM PERIPHERAL SPEED**

**8 m/s  
1570 ft/min**

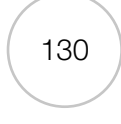

# > Spazzole Composite a disco / Composite disc brushes



[www.sitbrush.tv/cnc](http://www.sitbrush.tv/cnc)

## DISEGNI TECNICI / TECHNICAL DRAWINGS

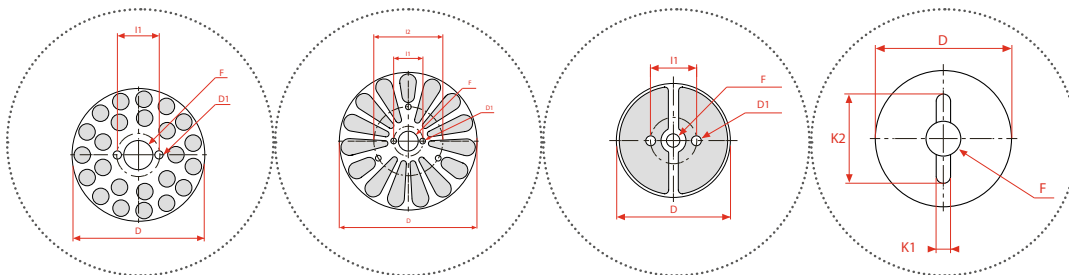

### LEGENDA PACK



**Single pack**  
e.g. 1/24  
Confezione singola con eventuale  
imballo secondario da 24 pezzi  
/ Single pack with 24-pcs  
secondary packaging (if any)

### LEGENDA FILO / FILAMENT



**Nylon abrasivo /  
Abrasive Nylon**  
Filamenti in Nylon abrasivo:  
CERAMIC = grana abrasiva ceramica  
Abrasive Nylon filaments:  
CERAMIC = abrasive ceramic grit

## NOTE / NOTES



Rispettare i limiti di velocità di rotazione MAX RPM con riferimento, per i prodotti del presente capitolo, ANSI 3.1.8, ANSI B165.1 e B165.2  
Observe speed restrictions MAX RPM in accordance with (for products in this chapter) ANSI 3.1.8, ANSI B165.1 e B165.2

**Gli articoli con la Ref rossa sono in pronta consegna /  
Items marked in RED are the best sellers / recommended choice**



**> Spazzole Composite a disco / Composite disc brushes**

Le spazzole composite a disco costituiscono un utensile spazzolante robusto e ad alta efficienza. Maggiori densità di filamento consentono una spazzolatura più aggressiva e rendono la spazzola ideale per la massima produttività. Sono disponibili differenti pattern di filamento per applicazioni che richiedono massima densità (pattern a goccia) o minore densità (pattern punzonato) o con configurazioni particolari di forma e filamento (su richiesta). Disegnati per il montaggio su centri di lavoro a controllo numerico o su altri utensili e macchinari.

Composite disc brushes are a sturdy, high-efficiency brushing tool. Greater filament density allows for more aggressive brushing and make the brush ideal for maximum productivity. Different filament patterns for applications requiring maximum density (teardrop pattern), or lower density (tufted pattern), or with particular shape and filament configurations are available (on request). Designed for mounting on CNC machining centres or other tools and machinery.



**Spazzole a disco / Disc brushes**

D		F		S		Pattern	MAX RPM		1mm-0,040"	1mm-0,040"	Adattatore/Adapter
mm	inch	mm	inch	mm	inch				gr80	gr120	Ref
102	4	22	7/8	38	1-1/2	Punzonato / Tufted	2500	1	<b>0571</b>	<b>0570</b>	<b>0578</b>
102	4	22	7/8	38	1-1/2	A goccia / Teardrop	2500	1	<b>0575</b>	<b>0574</b>	<b>0578</b>
152	6	22	7/8	38	1-1/2	Punzonato / Tufted	2000	1	<b>0573</b>	<b>0572</b>	<b>0579</b>
152	6	22	7/8	38	1-1/2	A goccia / Teardrop	2000	1	<b>0577</b>	<b>0576</b>	<b>0580</b>



**Spazzole a mini disco / Mini disc brushes**

D		F		S		MAX RPM		1mm-0,040"	1,4mm-0,055"	1mm-0,040"	Adattatore / Adapter
mm	inch	mm	inch	mm	inch			gr80	gr80	gr120	Ref
51	2	10	3/8	32	1-1/4	4500	1	<b>0582</b>	<b>0583</b>	<b>0581</b>	<b>0587</b>
76	3	10	3/8	32	1-1/4	4500	1	<b>0585</b>	<b>0586</b>	<b>0584</b>	<b>0587</b>

Alberi adattatori per spazzole a disco e mini disco con perni di centraggio e trascinamento, gambo di diametro 12mm (ref 0587) o 19mm (altre ref) con foro passante per il fluido lubro-refrigerante. / Adapter shafts for disc and mini disc brushes with centring and dragging pins, 12mm (ref 0587) or 19mm (other ref) diameter shank with through-hole for lubricating and cooling fluid.



**Spazzole a disco per mandrino porta fresa / Shell mill holder disc brushes**

D		F		S		Pattern	MAX RPM		1mm-0,040"	1mm-0,040"
mm	inch	mm	inch	mm	inch				gr80	gr120
51	2	19	3/4	38	1-1/2	Denso / Dense	2500	1	<b>0590</b>	
152	6	32	1-1/4	38	1-1/2	Denso / Dense	2500	1	<b>0592</b>	<b>0591</b>
152	6	32	1-1/4	38	1-1/2	Punzonato / Tufted	2500	1	<b>0589</b>	<b>0588</b>

Altre spazzole con filamento abrasivo ceramico studiate per la sbavatura all'interno del centro di lavoro sono disponibili nella categoria "Circolari da mola" alle pagg. 71-72, nella categoria "Anelli" pag 79 e nella categoria "Scovoli" pag 100. Other brushes with ceramic abrasive filament designed for deburring in machining centres are available in the "Wheels brushes" category on pages 71-72, in the "Single Section Wheels" category on page 79 and in the "Twisted-in Brushes" category on page 100.

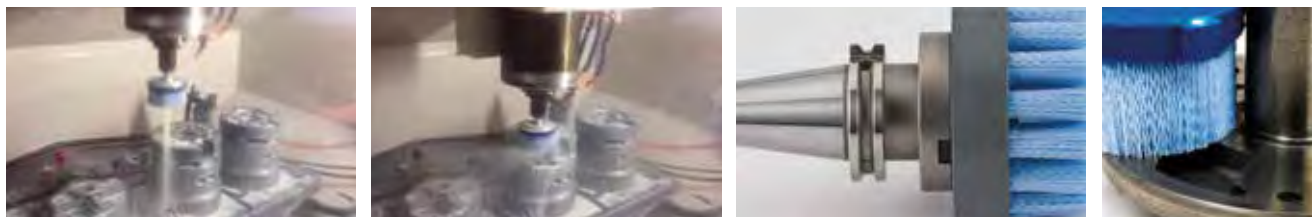

**APPLICAZIONI / APPLICATIONS**

Sbavare componenti stampati. Sbavare componenti settore aeronautico. Sbavare componenti fresati frontalmente. Smussare segni di rettifica. Migliorare la finitura superficiale. Sbavare e rifinire cerchioni in alluminio (grana 46) Deburring moulded parts. Deburring aerospace parts. Deburring front milled parts. Beveling grinding marks. Improving surface finishing. Deburring and finishing. Aluminium rims (46 grit).

**GUARDA IL VIDEO  
WATCH THE VIDEO**



[sitbrush.tv/cnc](http://sitbrush.tv/cnc)



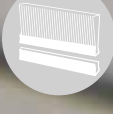
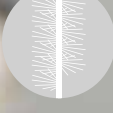

**SOLUZIONI  
ESPOSITIVE  
SOLUTIONS  
FOR DEALERS**

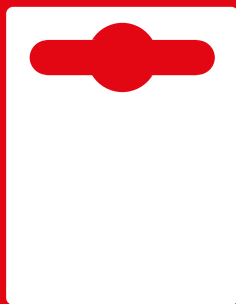

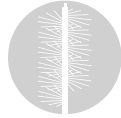

# > Soluzioni Espositive / Solutions for Dealers



## SERVIZI E SUPPORTI PER LA RIVENDITA / RETAIL AND POINT-OF-SALE SOLUTIONS

### Il valore di una efficace esposizione / The value of an effective products display

Il punto vendita rappresenta, in particolare nei nostri mercati, il vero momento di informazione, di comunicazione e di servizio per il cliente finale. È sul punto vendita che si trovano le risposte alle domande e ai bisogni, le informazioni per un acquisto consapevole, i professionisti ai quali affidarsi con fiducia.

Tutto inizia da una efficace esposizione delle categorie e dei prodotti: un punto vendita che si presenta con chiarezza, con esposizioni coerenti e comunicative facilita la scelta del cliente riducendo i tempi e i costi, sviluppa cross selling, aiuta nella comprensione delle differenze tra prodotti e soluzioni.

Con quali risultati? Valorizzazione del punto vendita e dei prodotti esposti, fidelizzazione della clientela e passaparola positivo, miglioramento costante della redditività.

*The Point-Of-Sale (POS) represents, especially in this market, the real moment and place where end users get information, communications and service. Here they can find answers to questions and needs, information for a conscious purchase, and reliable expert advice.*

*Everything starts with an effective products and categories display. A clearly presented store with communicative and consistent displays facilitates customer's choices reducing decision-making time and cost. It generates cross-selling effects, clarifies the difference between similar goods or services.*

*Expected outcomes?*

*Enhancement of the whole store, customer retention, positive word of mouth, continuous improvement in profitability.*

### La forza del packaging / The packaging strength

Una buona esposizione e un efficace rapporto con il cliente partono da un packaging che risponda alle esigenze di informazione, comunicazione ma anche di efficienza operativa, sia nella gestione dello scaffale, sia nella movimentazione di magazzino.

*A great display and a good relationship with customers start from a good packaging. This has to meet information, communication and operational efficiency needs, during both shelf managing and warehouse handling.*



### > Gli strumenti di SIT per una efficace esposizione / Our solutions for an effective display

SCELTE ESTETICHE PER UN FORTE IMPATTO DELLO SCAFFALE  
GREAT AESTHETIC IMPACT OF THE SHELF

PRODOTTO IN EVIDENZA PER FACILITARE LA SCELTA  
VISIBLE PRODUCTS FACILITATE THE PURCHASE DECISION MAKING

ISTRUZIONI PER UN USO DEL PRODOTTO IN SICUREZZA  
SAFETY INSTRUCTIONS

ICONE E CODICI QR PER GUIDARE LA SCELTA DELLA SPAZZOLA  
QR CODES AND ICONS HELP CHOOSING YOUR BRUSH



NUOVE ETICHETTE BARCODE CON INFO E FOTO PRODOTTO  
NEW LABELS BARCODES WITH INFO AND PHOTO OF THE PRODUCTS

FACILE INDIVIDUAZIONE DEI PRODOTTI "TECH"  
CLEAR DIFFERENTIATION OF "TECH" BRUSHES

PACKAGING CHE MASSIMIZZA L'EFFICIENZA OPERATIVA SULLO SCAFFALE E IN MAGAZZINO  
PACKAGING THAT ENHANCES OPERATIONAL EFFICIENCY ON THE SHELF AND IN THE WAREHOUSE



SIT ha sviluppato una serie di strumenti a supporto delle politiche espositive del rivenditore che rispondono alle diverse esigenze di visibilità e di presenza dei prodotti SIT. Tutte le soluzioni sono disponibili a fronte di un ordine minimo di prodotto. L'Ufficio Commerciale-Marketing di SIT è in grado di affiancare il distributore nella scelta della migliore soluzione espositiva sulla base delle esigenze del punto vendita, supportandolo nella configurazione della gamma in funzione della tipologia di clientela. SIT ha inoltre studiato una serie di optional di personalizzazione delle soluzioni espositive, per rendere ancora più unico e di impatto il punto vendita. Tutti gli optional sono forniti a fronte di minimi d'ordine e promozioni.

*SIT has developed several promotional materials and supports for the dealers, giving visibility and presence to its products. Every solution is available with a minimum order.*

*SIT Sales & Marketing staff helps the dealers choosing the best display solution for their store and setting up the product range according to target customers. Moreover SIT studied different customization for each display solution in order to increase the uniqueness and the aesthetic impact of the store. Different options and add-ons are supplied during promotions or with a specific minimum order value.*





## > Gli strumenti di SIT per una efficace esposizione / Our solutions for an effective display

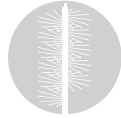

**OPTIONAL BANNER PERSONALIZZATO**  
SIT + Marchio del rivenditore  
**OPTIONAL CUSTOMIZED BANNER**  
SIT + Dealer brand

**OPTIONAL SCHERMO LCD**  
Video di spazzolatura, test comparativi e guida alla scelta  
**OPTIONAL LCD SCREEN**  
Comparative and "how-to" videos

**OPTIONAL MENSOLE E GANCI**  
Configurabili in base alle esigenze del punto vendita  
**OPTIONAL SHELVES AND HOOKS**  
According to the point-of-sale needs



**OPTIONAL TESTATA PERSONALIZZATA**  
SIT + Marchio del rivenditore  
**OPTIONAL CUSTOMIZED HEADBOARD**  
SIT + Dealer brand

**OPTIONAL SCHERMO LCD**  
Video di spazzolatura, test comparativi e guida alla scelta  
**OPTIONAL LCD SCREEN**  
Comparative and "how-to" videos

**OPTIONAL MENSOLE E GANCI**  
Configurabili in base alle esigenze del punto vendita  
**OPTIONAL SHELVES AND HOOKS**  
According to the point-of-sale needs

### Display MAXI

- Massimo impatto di prodotto / *Maximum product impact*
- Massima visibilità / *Maximum visibility*
- Massimo assortimento / *Widest product range displayed*
- Massimo profitto! / *Maximum profit!*

Dimensioni: 100x200x45 cm - 40x80x18 inch  
Size: 100x200x45 cm - 40x80x18 inch

**Codici / order codes:**  
MAXI display: 06006123  
ganci / hooks: 06006084  
ripiani / shelves: 06006124  
schermo / screen: 06006125  
banner IT: 06006057  
banner EN: 06006126  
porta banner / banner holder: 06006056

### Display ROLLER

- Ottimizzazione degli spazi / *Space optimization*
- Flessibilità espositiva / *High flexibility*
- Gamma equilibrata di soluzioni per le principali esigenze del cliente / *Well balanced product range*
- Forte impatto estetico / *Great aesthetic impact*

Dimensioni: 65x195x35 cm - 26x77x14 inch  
Size: 65x195x35 cm - 26x77x14 inch

**Codici / order codes:**  
ROLLER display: 06006122  
ganci / hooks: 06006121  
schermo / screen: 06006125  
testata / headboard IT: 05007317  
testata / headboard EN: 05007336



**RUOTE**  
per la massima flessibilità nell'allestimento del punto vendita  
**WHEELS**  
Maximum flexibility for display position changing

### > Gli strumenti di SIT per una efficace esposizione / Our solutions for an effective display



#### Espositori da banco/Desk display

- **Compattezza e flessibilità / Compactness and flexibility**
- **Efficace impatto dal bancone al cliente / Effective impact from the desk to the customer**
- **Comprensivi di depliant dedicati! / Including dedicated flyer**

Dimensioni espositore SCOVOLI: 24,5x35,5x7,5 cm  
9,65x14x3 inch

Size display SCOVOLI: 24,5x35,5x7,5 cm  
9,65x14x3 inch

Dimensioni espositore DEPLIANT: 21x30x12,5 cm  
8,27x11,81x5 inch

Size display DEPLIANT: 21x30x12,5 cm  
8,27x11,81x5 inch

#### Codici / order codes:

**SCOVOLI display: 06006196**

**DEPLIANT display: 06006197**

#### Display STRIP

SIT è sempre alla ricerca di nuove soluzioni capaci di dare una risposta efficace a una delle principali esigenze dei propri distributori: valorizzare il punto vendita, al fine di soddisfare il cliente finale. Un approccio, questo, adottato anche quando ci rivolgiamo a distributori specializzati, per i quali studiamo soluzioni personalizzate, come l'espositore di spazzole lineari Strip, appositamente ideato per i rivenditori serramentisti che servono il mercato degli infissi e dell'edilizia. Gli strip, inoltre, si rivelano una soluzione efficace per moltissime altre applicazioni industriali.

Tutti gli articoli in assortimento con l'espositore sono etichettati con descrizione articolo e barcode.

*SIT is always looking for new and better solutions in order to provide an effective response to its distributors' main need: improve the point-of-sale and satisfy end users. We have the same approach towards our specialized dealers for whom we study customized solutions, such as the Strip display, specifically designed for all those retailers serving the doors and window market and the construction industry. Moreover, strip brushes are an effective solution in many other industrial applications.*

*All items sold with the display are individually labeled with their item description and barcode.*

Dimensioni: 60x250x60 cm - 24x100x24 inch

Size: 60x250x60 cm - 24x100x24 inch

#### Codici / order codes:

**STRIP display: 06006049**





## > Gli strumenti di SIT per una efficace esposizione / Our solutions for an effective display

### Le Tue Soluzioni Espositive / Your Display Solutions

Oltre alla gamma di espositori display, da terra o da banco, abbiamo studiato ogni nostra confezione affinché costituisca in sé e per sé un'unità espositiva che mostri chiaramente il prodotto e tutte le informazioni a esso correlate, trasformandosi, con il marchio rosso SIT, in un elemento focale all'interno del punto vendita.

È nostro obiettivo supportare i nostri rivenditori con tutti quegli strumenti che possano aiutarlo a migliorare la presentazione e le performance sul suo punto vendita delle nostre categorie di prodotto, convinti che una crescita delle categorie rappresenti un'opportunità di crescita anche per i nostri prodotti.

*We designed our packaging so that it can be used as a display unit, in addition to floor and desk displays.*

*SIT packaging clearly shows the product and all the related information and, thanks to our bright red brand, it becomes a point of interest in every store.*

*Our goal is to provide the dealers all the tools to improve presentation and performances of our sales categories. We firmly believe that their growth is a great growth opportunity for our products.*



### Finecorsa / Reorder tag

Nuovi cartellini finecorsa utili a facilitare la disposizione e l'identificazione dei prodotti SIT sull'espositore, velocizzandone il riordino.

**Cod. FINECORSA: 05005001**

*New reorder tag useful to facilitate the location and identification of SIT products on the display stand, speeding up their rearrangement.*

**Code REORDER TAG: 05005001**



Il nostro Staff Commerciale e Marketing e i nostri agenti sono pronti ad assistere i clienti nella scelta e nella personalizzazione della soluzione. In fondo a questo catalogo troverete i nostri contatti: chiamateci al +39 051 6113211, o scriveteci su [info@sitbrush.com](mailto:info@sitbrush.com)

*Our Sales & Marketing office and our trusted sales force help customers in finding the best solution for them with standard or customized brushes. At the end of the catalogue you can find our contacts: please call us at +39 051 6113211 or write at [info@sitbrush.com](mailto:info@sitbrush.com)*

[www.sitbrush.tv](http://www.sitbrush.tv)  
[www.sitbrush.com](http://www.sitbrush.com)



## > Spazzole per smerigliatrice / Brushes for grinder

BLISTER  
TRASPARENTE ULTRA  
RESISTENTE  
ULTRA RESISTANT  
TRANSPARENT BLISTER

ISTRUZIONI PER UN USO DEL  
PRODOTTO IN SICUREZZA  
INSTRUCTIONS FOR SAFE  
PRODUCT USE

ICONE E CODICI QR (VIDEO) PER  
GUIDARE LA SCELTA DELLA  
SPAZZOLA  
ICONS AND QR CODES (VIDEO) TO  
GUIDE THE CHOICE OF BRUSH



PRODOTTO IN EVIDENZA  
PER FACILITARE LA SCELTA  
HIGHLIGHTED PRODUCT  
FOR EASIER CHOICE



GUIDA PER LA SCELTA DELLA SPAZZOLA IDEALE E  
ISTRUZIONI PER UN USO SICURO DEL PRODOTTO  
GUIDE TO CHOOSE THE IDEAL BRUSH AND  
INSTRUCTIONS FOR A SAFE USE OF THE PRODUCT

FOTO DI  
APPLICAZIONI  
DEDICATE  
PHOTOS OF  
DEDICATED  
APPLICATIONS

BARCODE PER GESTIRE  
FACILMENTE IL MAGAZZINO  
E LA SINGOLA VENDITA  
BARCODE FOR EASY  
INVENTORY AND SALE  
MANAGEMENT

D		F	MAX RPM	Linea Range		ART	0,30mm	0,35mm	0,50mm	0,30mm
mm	inch						0,012"	0,014"	0,020"	0,012"
70	2-3/4	M14	14000	Tech	B/6/48	<b>B TU71</b>		<b>0730</b>		<b>0935*</b>
70	2-3/4	M10	14000	Tech	B/6/48	<b>B TU71</b>		<b>0731</b>		<b>0943*</b>
80	3-1/4	M14	14000	Tech	B/6/48	<b>B T80</b>				<b>0925</b>
80	3-1/4	M10	14000	Tech	B/6/48	<b>B T80</b>				<b>0942</b>
100	4	M14	8500	Tech	B/6/48	<b>B T100</b>				<b>0930</b>
75	3	M14	14000	Sit	B/6/48	<b>B TZ70</b>		<b>0740</b>		
100	4	M14	8500	Sit	B/6/24	<b>B TZ100</b>		<b>0320</b>		
120	4-3/4	M14	8500	Sit	B/6/18	<b>B TZ120</b>		<b>0322</b>		
60	2-3/8	M14	14000	Sit	B/6/48	<b>B TE60</b>	<b>0228</b>			
80	3-1/8	M14	14000	Sit	B/6/48	<b>B TE80</b>	<b>0725</b>			
100	4	M14	8500	Sit	B/6/24	<b>B TE100</b>	<b>0110</b>			
120	4-3/4	M14	6600	Sit	B/6/24	<b>B TE120</b>	<b>0120</b>			



\* Diametro filo 0,50mm / Wire diameter 0,020"

D		F	MAX RPM	Linea Range		ART	0,30mm	0,50mm	0,30mm
mm	inch						0,012"	0,020"	0,012"
95	3-3/4	M14	14000	Tech	B/6/48	<b>B CZ95</b>		<b>0760</b>	<b>0950*</b>
95	3-3/4	M10	14000	Tech	B/6/48	<b>B CZ95</b>		<b>0761</b>	<b>0949*</b>
90	3-1/2	M14	14000	Tech	B/6/48	<b>B C090</b>			<b>0945</b>
90	3-1/2	M14	14000	Sit	B/6/48	<b>B C090E</b>	<b>0745</b>		
90	3-1/2	M10	14000	Sit	B/6/48	<b>B C090E</b>	<b>0746</b>		
120	4-3/4	M14	12500	Sit	B/6/48	<b>B C0120E</b>	<b>0222</b>		

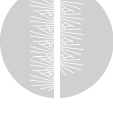



# SOLUZIONI ESPOSITIVE / SOLUTIONS FOR DEALERS

## > Spazzole per trapano / Brushes for drill

D		Shank		MAX RPM	Linea Range		ART	0,30mm	0,30mm	0,20mm	1mm
mm	inch	mm	inch					0,012"	0,012"	0,008"	120gr
60-50	2-3/8	30	1-1/8	12500	Tech	B/6/48	<b>CLEPSYDRA</b>	<b>0880</b>	<b>0891</b>	<b>0883</b>	<b>0893</b>
70	2-3/4	25	1	15000	Tech	B/6/48	<b>B GG73</b>	<b>0217</b>			
100	4	25	1	10000	Tech	B/6/48	<b>B GG103*</b>	<b>0219</b>			
70	2-3/4	25	1	20000	Tech	B/6/48	<b>B GZ71**</b>	<b>0301</b>			
30	1-1/8	25	1	6000	Sit	B/12/96	<b>B G30</b>	<b>0220</b>			
50	2	25	1	4500	Sit	B/12/96	<b>B G50</b>	<b>0218</b>			
50	2	25	1	4500	Sit	B/6/48	<b>B G50</b>		<b>0965</b>		
75	3	25	1	4500	Sit	B/12/96	<b>B G75</b>	<b>0216</b>			
75	3	25	1	4500	Sit	B/6/48	<b>B G75</b>		<b>0970</b>		
100	4	25	1	4500	Sit	B/12/96	<b>B G100</b>	<b>0205</b>			
100	4	25	1	4500	Sit	B/6/48	<b>B G100</b>		<b>0975</b>		

\* Acciaio ottonato / Brass Plated Steel

\*\* Acciaio 0,50mm / Wire diameter 0,020"

D		Shank		MAX RPM	Linea Range		ART	0,30mm	0,35mm	0,30mm
mm	inch	mm	inch					0,012"	0,014"	0,012"
70	2-3/4	25	1	12000	Tech	B/6/48	<b>B T70</b>	<b>0211</b>		
70	2-3/4	25	1	6500	Tech	B/6/48	<b>B TGZ70</b>		<b>0304</b>	
50	2	25	1	4500	Sit	B/12/96	<b>B TE50</b>	<b>0200</b>		
50	2	25	1	4500	Sit	B/6/48	<b>B TE50</b>		<b>0980</b>	
75	3	25	1	4500	Sit	B/12/96	<b>B TE75</b>	<b>0202</b>		
75	3	25	1	4500	Sit	B/6/48	<b>B TE75</b>		<b>0985</b>	
85	3-5/8	25	1	4500	Sit	B/6/48	<b>B TE85</b>	<b>0227</b>		
95	3-3/4	25	1	6500	Tech	B/6/48	<b>B CZ95 G</b>		<b>0306</b>	
90	3-1/2	25	1	6500	Tech	B/6/48	<b>B C090 G</b>	<b>0212</b>		<b>0940</b>

D		Shank		MAX RPM	Linea Range		ART	0,30mm	0,30mm
mm	inch	mm	inch					0,012"	0,012"
15	3/8	20	3/4	20000	Tech	B/6/48	<b>B P10</b>		<b>0955</b>
18	3/4	22	7/8	18000	Sit	B/12/96	<b>B PE15</b>	<b>0209</b>	
22	7/8	18	3/4	18000	Sit	B/6/48	<b>B PE20</b>		<b>0960</b>
28	1	20	3/4	18000	Sit	B/12/96	<b>B PE25</b>	<b>0210</b>	

Contenuto / Content		Linea Range		ART	0,10mm	0,30mm	0,30mm
					0,004"	0,012"	0,012"
TE75 + G100 + PE20		Sit	B/6/48	<b>KIT MARINE</b>			<b>0990</b>
PE15 + TE50 + G75		Sit	B/6/48	<b>MINI DRILL</b>		<b>0362</b>	
PE25 + TE75 + G100		Sit	B/6/48	<b>MAXI DRILL</b>		<b>0363</b>	
MSC + MST + MSP		Sit	B/6/48	<b>MINI KIT</b>	<b>0370</b>		

D		Shank		MAX RPM	Linea Range		ART	Abrasis A	Abrasis B	Grana / Grit	Panno Cloth
mm	inch	mm	inch					120 gr	180 gr	80 gr	
75	3	30	1-1/8	4500	Sit	B/6/48	<b>B G75A - B G75B</b>	<b>0610</b>	<b>0620</b>		
100	4	30	1-1/8	4500	Sit	B/6/48	<b>B G100A - B G100B</b>	<b>0612</b>	<b>0622</b>		
50	2	30	1-1/8	4500	Sit	B/6/48	<b>B T50A - B T50B</b>	<b>0614</b>	<b>0624</b>		
75	3	30	1-1/8	4500	Sit	B/6/48	<b>B T75A - BT75B</b>	<b>0616</b>	<b>0626</b>		
22	7/8	30	1-1/8	4500	Sit	B/6/48	<b>B P20A - B P20B</b>	<b>0618</b>	<b>0628</b>		
50	2	25	1	13700	Sit	B/6/48	<b>B RL50</b>			<b>0410</b>	
80	3-1/8	40	1-5/8	8600	Sit	B/6/48	<b>B RL80</b>			<b>0411</b>	
80	3-1/8	40	1-5/8	4000	Sit	B/6/48	<b>B SP80</b>				<b>0402</b>

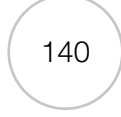
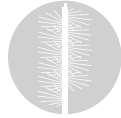

## > Varie / Various

### Spazzole per mola / Brushes for bench grinder

D		F		MAX RPM	Linea Range		ART	0,30mm	0,30mm	Panno Cloth
mm	inch	mm	inch					0,012"	0,012"	
125	5	16	5/8	6000	Tech	B/6/48	<b>B 3122</b>		<b>0915</b>	
150	6	KITmm		6000	Tech	B/6/48	<b>B 4152</b>		<b>0920</b>	
100	4	13	1/2	6000	Sit	B/6/48	<b>B CE100</b>	<b>0214</b>		
100	4	16	5/8	6000	Sit	B/6/48	<b>B CE3103</b>	<b>0705</b>		
120	4-3/4	16	5/8	6000	Sit	B/6/48	<b>B CE120</b>	<b>0215</b>		
125	5	16	5/8	6000	Sit	B/6/48	<b>B CE3122</b>	<b>0710</b>		
150	6	KITmm		6000	Sit	B/6/48	<b>B CE4151</b>	<b>0101</b>		
150	6	KITmm		6000	Sit	B/6/48	<b>B CE4152</b>	<b>0715</b>		
150	6	16-20	5/8-3/4	4000	Sit	B/6/48	<b>B SP 150</b>			<b>0404</b>



### Spazzole a mano / Hand brushes

Descrizione / Description	Linea Range		ART	0,30mm	0,30mm	0,30mm	Nylon rigido / hard
				0,012"	0,012"	0,012"	
	Sit	B/12/96	<b>SPID</b>	<b>0005</b>	<b>0006</b>	<b>0007</b>	<b>0008</b>



Slim Acciaio / Steel 0,2mm - 0,008" + Slim ottone / brass 0,2mm - 0,008"	Sit	B/12/96	<b>SLIM DUO</b>	<b>0026</b>			
Slim Acciaio Inox / S-steel 0,2mm - 0,008" + Slim Nylon	Sit	B/12/96	<b>SLIM DUO</b>	<b>0027</b>			



### Scovoli / Twisted in brushes

D		Shank		MAX RPM	Linea Range		ART	0,30mm
mm	inch	mm	inch					0,012"
28	1-1/8	25	1	500	Sit	B/12/96	<b>B ST</b>	<b>0450</b>



### Box misti minismerigliatrice / Mixed box for mini-grinder

Contenuto / Content		Ref
4 TU71 M14 (Ref 0240) + 4 T80 M14 (Ref 0127) + 4 CZ95 M14 (Ref 0309) + 4 CO90 M14 (Ref 0173)	1/4	<b>0360</b>
4 TZ70 M14 (Ref 0325) + 4 TE80 M14 (Ref 0105) + 4 CZ95 M14 (Ref 0309) + 4 CO90 E M14 (Ref 0106)	1/4	<b>0361</b>
1 TZ70 XLK (Ref 6000) + 1 T80 XLK (Ref 6002) + 1 CZ95 XLK (Ref 6004) + 1 CO90 XLK (Ref 6016)	1/4	<b>6020</b>



### Box misti trapano / Mixed box for drill

Contenuto / Content		ART	Ref
8 G50 (Ref 0887) + 8 G60 (Ref 0888) + 8 TE50 (Ref 0660) + 8 TE75 (Ref 0661) + 8 PE20 (Ref 0795)	1/8	<b>SUPER 5</b>	<b>0895</b>
2 G75A (Ref 0609) + 2 G75B (Ref 0619) + 2 G100A (Ref 0611) + 2 G100B (Ref 0621) + 2 T50A (Ref 0613) + 2 T50B (Ref 0623) + 2 T75A (Ref 0615) + 2 T75B (Ref 0625) + 2 P20 A (Ref 0617) + 2 P20B (Ref 0627)	1/8	<b>BOX ABRASIT</b>	<b>0645</b>
4 GG52HEX (Ref 0864) + 4 T60HEX (Ref 0656) + 4 P24HEX (Ref 0824)	1/8	<b>BOX HEX</b>	<b>0897</b>
5 Clepsydra Acciaio/Steel (Ref 0880) + 5 Clepsydra Inox (Ref 0891) + 5 Clepsydra Ottone/Brass (Ref 0883) + 5 Clepsydra Nylon (Ref 0893)	1/8	<b>BOX CLEPSYDRA 8pz</b>	<b>0338</b>

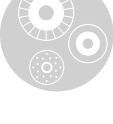
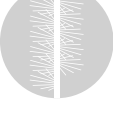

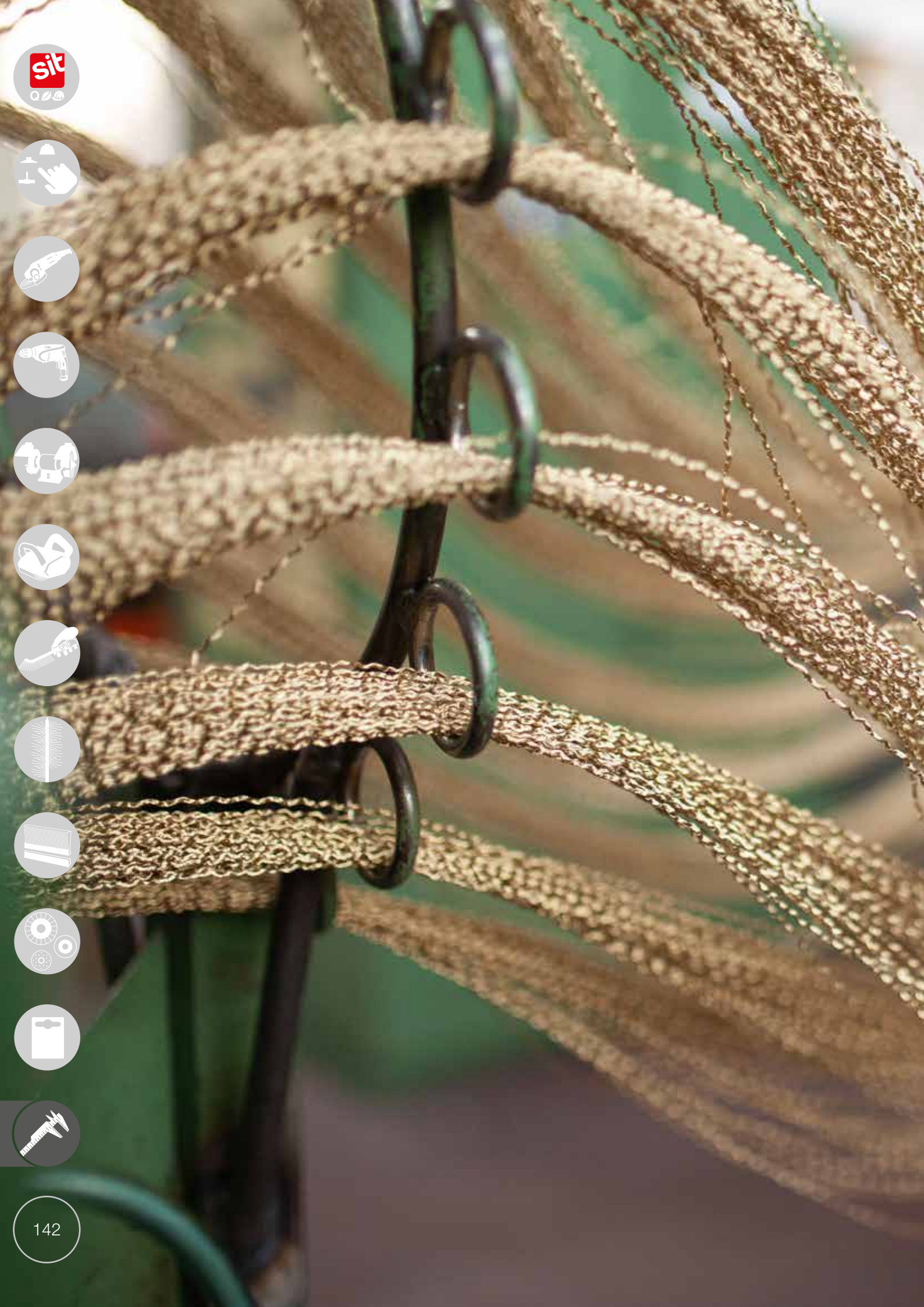

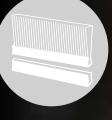
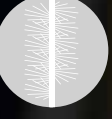

**SOLUZIONI  
TECNICHE**  
*TECHNICAL  
SOLUTIONS*

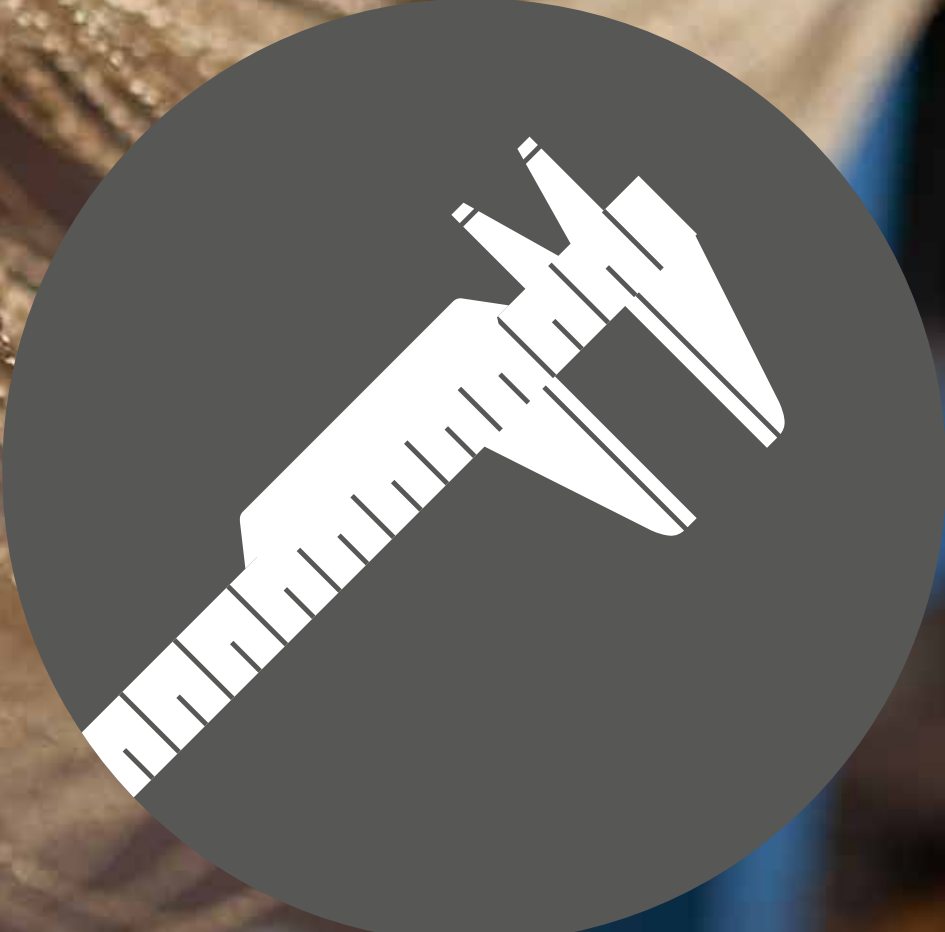

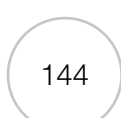
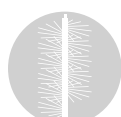

# > Soluzioni tecniche / Technical solutions

SIT ha acquisito negli anni una forte esperienza nello sviluppo e nell'ingegnerizzazione di soluzioni personalizzate che rispondano alle esigenze più specifiche dei propri clienti. Nelle "Soluzioni Tecniche", si riflettono l'anima Tecnica, l'esperienza e la curiosità dello staff di SIT nell'affiancare il cliente per la ricerca di una Soluzione realmente customizzata.

Ogni superficie - sia essa un pannello di legno o una lamiera in acciaio - subisce un trattamento durante il suo ciclo di fabbricazione, prima di essere fornita all'utente finale. I trattamenti superficiali possono essere di carattere chimico o meccanico, ma in entrambi i casi è facile che la superficie venga a contatto con un elemento spazzolante.

È in questa fase che vengono messe in campo tutte le competenze, la professionalità e la passione di SIT, sempre impegnata a offrire, grazie al lavoro del suo Ufficio Tecnico, del suo Ufficio Commerciale e del suo staff, la migliore delle soluzioni a ogni singolo cliente.

Nelle prossime pagine troverete possibili applicazioni e soluzioni. All'interno di "Modalità Costruttive" vengono mostrate alcune delle diverse tipologie di spazzole industriali. Potrete quindi riconoscere un'utilizzo simile alle vostre esigenze nella sezione "Applicazioni Industriali" all'interno della quale vengono mostrate alcune delle principali applicazioni dei clienti e settori industriali di SIT.

In coda a questa sezione troverete delle schede di configurazione prodotto che vi potranno essere d'aiuto nella definizione delle specifiche tecniche della spazzola per la vostra applicazione. Con queste informazioni il nostro Ufficio Tecnico-Commerciale sarà disponibile a studiare e sviluppare insieme a voi una soluzione su misura per le vostre esigenze.

*SIT is designing and manufacturing technical brushes for customer's specific needs since 1960s.*

*Very important elements in these industrial brushes are SIT's Technical knowledge, experience and it's staff curiosity in supporting the customer side by side in the custom Solution development.*

*Every surface, be it a wood plank or a steel sheet, undergoes a surface finishing process when manufactured. These surface finishings can be chemical or mechanical but in both cases they will most probably be treated by a brushing tool.*

*During this phase SIT uses it's expertise, knowledge and passion to provide, through it's Technical and Sales Staff, the best solution in every detail to each customer.*

*Inside these pages you will find an overview on technical brushes applications and solutions. Inside "Manufacturing Types" section are illustrated different kind of technical brushes. You can find then a use close to your specific needs under "Industrial Application" section where some of SIT's main customers and industries applications are described.*

*After these sections you can find several technical sheets/forms that will help you in designing your brush with the definition of your application's variables. With these informations please contact our Technical/Sales Office: we will be glad to assist you and to develop together a custom solution for your needs.*





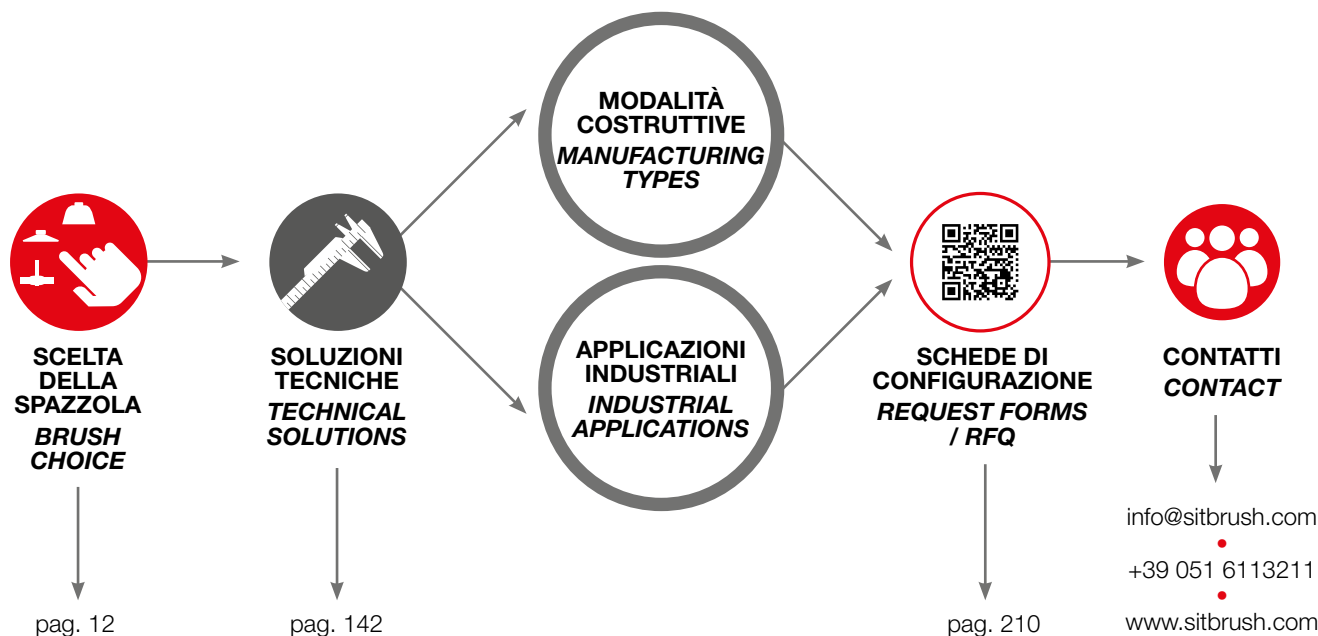

\* Consigliamo di prendere conoscenza delle informazioni di base nel capitolo "Scelta della Spazzola" a pag. 12 prima di approcciare questa sezione del catalogo.

*We recommend to read the "Brush choice" chapter at page 12 before approaching this section.*















### MODALITÀ COSTRUTTIVE / MANUFACTURING TYPES

-  > **Strip - spazzole lineari**  
*Strip linear brushes* p. 146
-  > **Spirali e spazzole a rullo**  
*Roller brushes and spirals* p. 149
-  > **Rulli master**  
*Master rolls* p. 156
-  > **Spazzole ad anello**  
*Single section wheel brushes* p. 158
-  > **Spazzole composite e sbavatura di metalli duri**  
*Composite brushes and hard metal deburring* p. 162
-  > **Spazzole punzonate**  
*Staple set brushes* p. 172



### APPLICAZIONI INDUSTRIALI / INDUSTRIAL APPLICATIONS

-  > **Trattamento leghe leggere e applicazioni del nylon abrasivo**  
*Aluminium alloys treatment and abrasive nylon applications* p. 174
-  > **Spazzole per laminazione**  
*Brushes for rolling mills* p. 180
-  > **Unità spazzolanti per nastri trasportatori**  
*Brushing units for conveyor belts* p. 184
-  > **Spazzole per ricostruzione pneumatici**  
*Brushes for tyre retreading industry* p. 190
-  > **Spazzole per trattamento legno**  
*Brushes for woodworking* p. 194
-  > **Unità Spazzolanti per il trattamento pannelli**  
*Brushing Units for panels treatment* p. 196
-  > **Spazzole per sbavatura tubi**  
*Brushes for pipe deburring* p. 199
-  > **Spazzole per settore pipeline**  
*Brushes for the pipeline industry* p. 202
-  > **Spazzole per fonderia**  
*Brushes for foundry industry* p. 206
-  > **Spazzola per pannelli fotovoltaici e solari**  
*Brush for photovoltaic and solar panels* p. 208

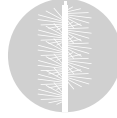

# > Strip / Strip brushes

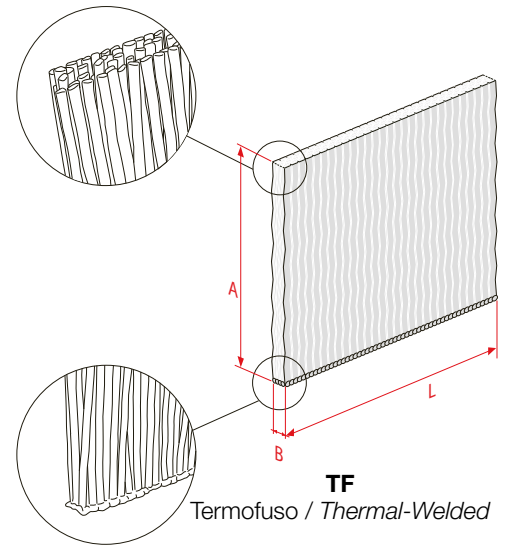
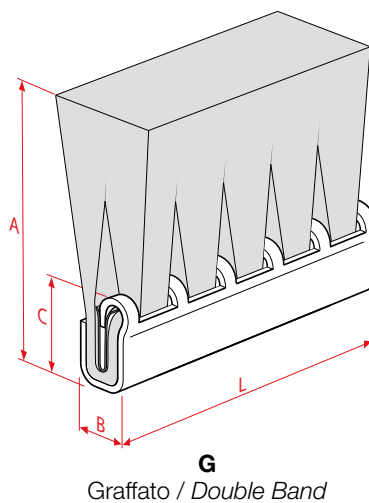
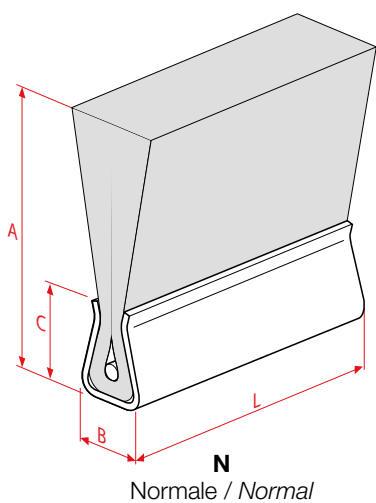

Lo **Strip** è una **spazzola lineare continua**, con filamenti che possono essere di tipo sintetico, abrasivo, metallico (acciaio, inox, ottone, bronzo fosforoso), vegetale, animale o misto, montati su profilato ad U in lamiera (lucida, zincata, di acciaio inossidabile) che funge da supporto. Il filamento, qualunque siano la sua natura e il suo diametro, è piegato a U e bloccato in questa **guaina metallica** senza possibilità di fuoriuscita. Lo strip termofuso (TF) può essere completato con supporto senza alcuna parte metallica. Gli Strip possono essere curvati e sagomati a tazza, a fili interni o esterni, oppure montati su supporti speciali per ogni tipo di esigenza.

**Strip brushes are linear continuous brushes**, made of synthetic, abrasive, metallic (steel, stainless steel, brass, phosphorous bronze), vegetal, animal hair or mixed filaments, mounted on a U-shaped profiled backing (iron zinc plated or stainless steel). The filament, no matter its nature and diameter, is U-bent and blocked in this metallic backing without possibility of coming out. Thermal-welded strip (TF) can be closed with proper tape without any metallic component. Strip brushes can be bent and cup shaped, with internal or external wires, or mounted on special supports for any need.

## Dimensioni massime e minime realizzabili / Maximum and minimum dimensions

	B		C		A (min → max)		D1 (max)		D2 (max)		L (min → max)		GA	GL
	mm	inch	mm	inch	mm	inch	mm	inch	mm	inch	mm	inch		
<b>N</b>	2,5	3/32	2,5	3/32	8→100	5/16→4	0,4	0,016			20→3000	3/4→118	•	
	4	5/32	3,8	5/32	8→100	5/16→4	0,4	0,016			20→6000	3/4→236	•	
	5	3/16	5,2	3/16	15→125	5/8→5	0,5	0,020	0,5	0,020"	20→6000	3/4→236	•	
	8	5/16	9	5/8	20→250	3/4→10	0,8	0,031	0,5	0,020"	20→6000	3/4→236	•	•
	10	3/8	12,5	1/2	25→375/500	1→15/20	1,8/0,8	0,071"/0,031	0,5	0,020"	30→6000	1-1/4→236		•
	13	1/2	19	3/4	35→375	1-3/8→15	3	0,118	0,5	0,020"	60→6000	2-3/8→236		•
	14	5/8	18,5	47/64	35→375	1-3/8→15	3	0,118	0,5	0,020"	60→6000	2-3/8→236		
<b>G</b>	19	3/4	25	1	50→180	2→7-1/8	3	0,118	0,5	0,020"	100→2500	4→98		
	6	1/4	8	5/16			0,8	0,031						
<b>TF</b>	8	5/16	11	7/16			3	0,118						
	12	1/2			80→500	3-1/8→20	3	0,118			80→1000	3-1/8→39		

**LEGENDA**

- B** = Base strip / Strip base
- C** = Altezza nastro / Support height
- A** = Altezza Strip / Strip height
- D1** = Diametro filamenti sintetici / Synthetic filament diameter
- D2** = Diametro filamenti metallici / Metallic wire diameter
- L** = Lunghezza / Length
- GA** = Guaina in aletta di alluminio / Aluminium finned tape
- GL** = Guaina semplice o alettata in lamiera / Simple or finshaped tinplate tape

## > Strip / Strip brushes

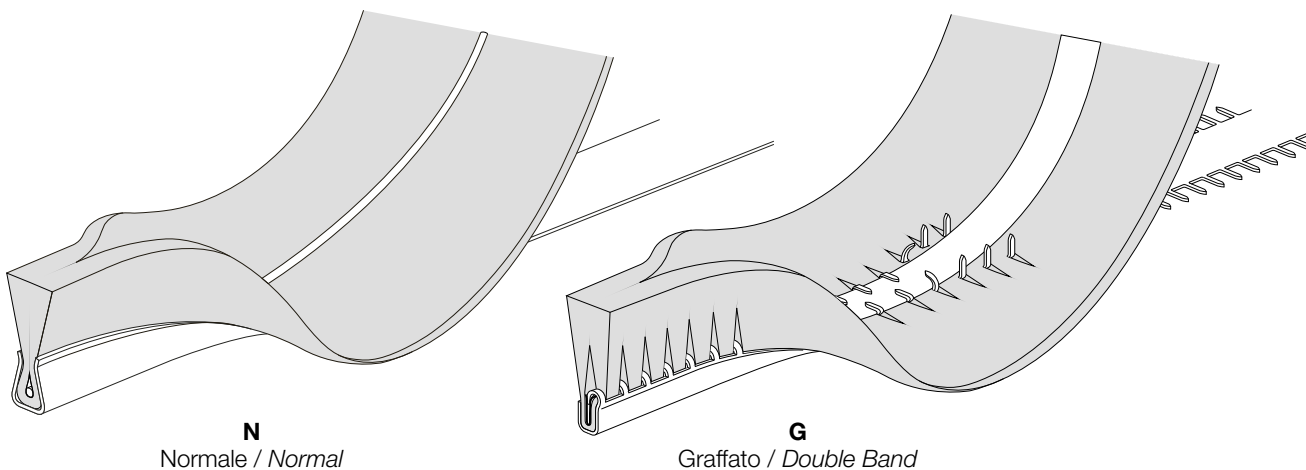

### Tipologie costruttive delle spazzole Strip / Strip brushes constructive features

SIT Tecnospazzole propone diverse tipologie di **spazzole lineari industriali** che si differenziano per come il filamento viene montato e chiuso.

**Tipo N - Normale:** i filamenti sono distribuiti in modo continuo e la spazzola è più fitta (una selezione degli strip industriali di tipo N più diffusi è visibile a pagg. 118-120).

**Tipo G - Graffato:** la graffatura del nastro dispone il filamento a mazzetti e lo rende particolarmente adatto alle alte velocità di rotazione. Molto utilizzato per la formazione di spazzole a spirale.

**Tipo TF - Termofuso:** i filamenti sono termosaldati, non vi è quindi alcun blocco meccanico fatto con parti metalliche.

SIT Tecnospazzole offers several types of **linear strip brushes**, with filaments mounted and closed in different ways.

**Type N - Normal:** filaments are uniformly distributed and the brush has a higher filling density (the most common range of type N industrial strips can be found at pages 118-120).

**Type G - Double band:** the clinching of the tape sets the filament out in knots and makes it recommended for high rotational speed. It is mainly used to form spiral brushes.

**Type TF - Thermal welded:** the filaments are welded and there is no mechanical blocking made of metallic parts.



## > Guaine / Tapes

### GL

Guaina in lamiera, semplice o alettata  
*Simple or finshaped tinplate tape*

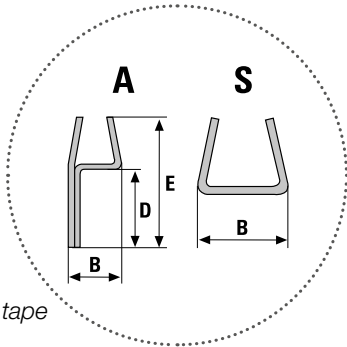

### GA

Guaina in alluminio estrusa con aletta  
*Extruded finned aluminium tape*

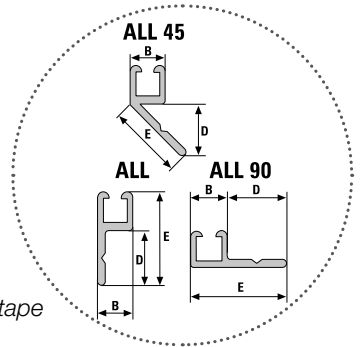

### Guide/guaine di supporto per strip / Tapes and supports

Spesso gli Strip lineari hanno bisogno di un supporto per poter essere applicati a porte, portoni, parti di macchinario o altro. Tali guide possono essere semplici o alettate e sono disponibili in diversi materiali (lamiera zincata, acciaio inox o alluminio, come potete vedere a pag 117).

Support tapes are needed to apply strip brushes on doors and main doors but also to fit in machinery and more. These supports called tapes, can be simple or finned depending on the mounting requirements. Different materials available (steel, stainless steel, aluminium, see page 117).

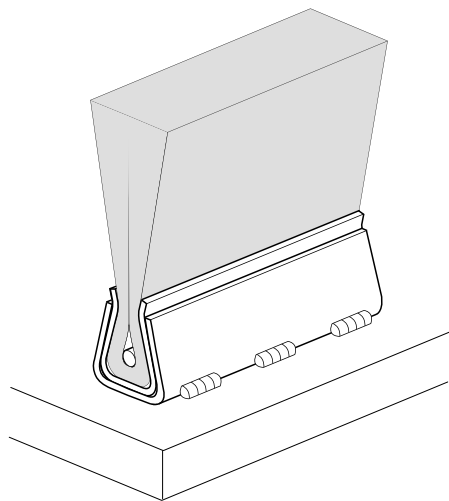

GUAINA GL-S / "GL-S" TAPES

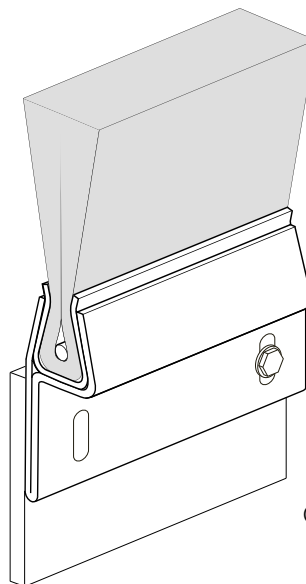

GUAINA GL-A / "GL-A" TAPES



Le guaine di supporto possono essere saldate o montate con viti o rivetti in autonomia su tutte le superfici. Ciò conferisce alle spazzole Strip un'incredibile versatilità nelle forme e nelle specifiche e le rende adatte per ogni applicazione.

Support tapes can be welded or mounted on any surface. This makes strip brushes incredibly versatile in their brush characteristics and shape and makes them customizable to fit any application.



> **Spirali / Spiral brushes**

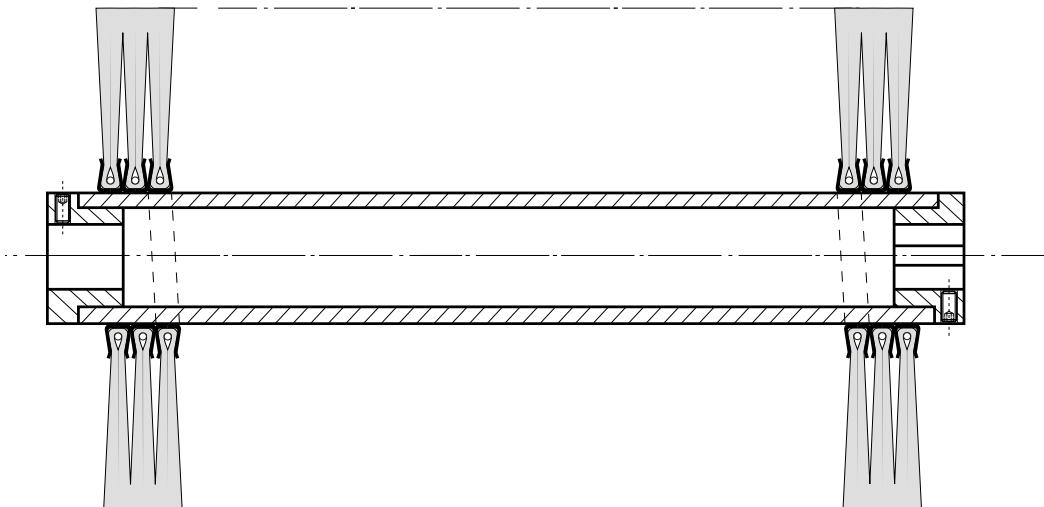

Le spazzole a spirale sono costituite da uno Strip avvolto a diametro interno predefinito e possono essere "assemblate" su un nucleo opportunamente fissato oppure "libere", come ricambi da montarsi a cura del cliente.

Le spazzole a spirale sono quanto di meglio si possa avere sia in termini di superficie spazzolante omogenea sia in termini di **economia di acquisto** (nucleo riutilizzabile) e di **manutenzione**, sia in termini di **resa meccanica**.

La flessibilità di costruzione permette di ottenere combinazioni tra dimensioni, densità, sporgenza e tipo di filamento praticamente infinite, rendendo possibile qualsiasi tipo di trattamento superficiale.

*Spiral brushes are made of a spiral Strip brush with a defined inner diameter. Spirals can be "assembled" on a shaft properly fixed or "free" as spare parts to be assembled by the customer. Spiral brushes are the best you can get in terms of homogeneous brushing surface **price** (reusable shaft), **maintenance** and **mechanical performance and efficiency**.*

*The manufacturing flexibility allows to obtain every possible combination between size, density, trim length and filling material, making it very versatile in order to perform every type of surface treatment.*



**Dimensioni massime e minime realizzabili / Maximum and minimum dimensions**

		MIN		MAX	
		mm	inch	mm	inch
Diametro esterno <i>Outer diameter</i>	<b>A</b>	40	1-5/8	1000	39-3/8
Diametro interno <i>Inner diameter</i>	<b>D</b>	12	1/2	500	20
Lunghezza <i>Length</i>	<b>LU</b>	5	3/16	4800	189
Passo (densità) <i>Pitch (density)</i>	<b>P</b>	5	3/16	70	2-3/4

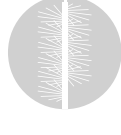
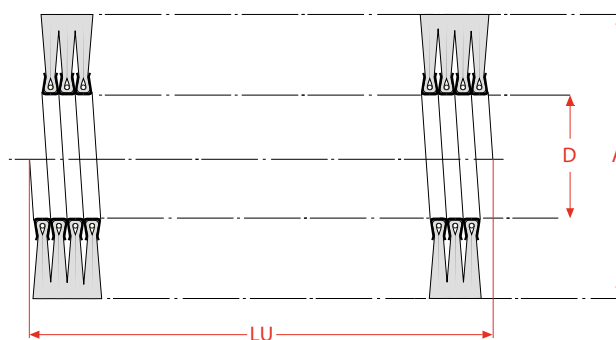



## > Spirali / Spiral brushes

### Densità, accostamento e orientamento delle spire / Density, coils pitch and orientation

Gli avvolgimenti della spirale, possono essere accostati oppure distanziati.

La densità, o foltezza, della superficie spazzolante può essere infatti identificata con il passo di avvolgimento oppure con il numero delle spire montate sul nucleo.

The coils of the spiral brush may be wound up closed to or distanced.

The fill density of the brushing surface is determined by the winding pitch and by the number of coils wound onto a shaft.

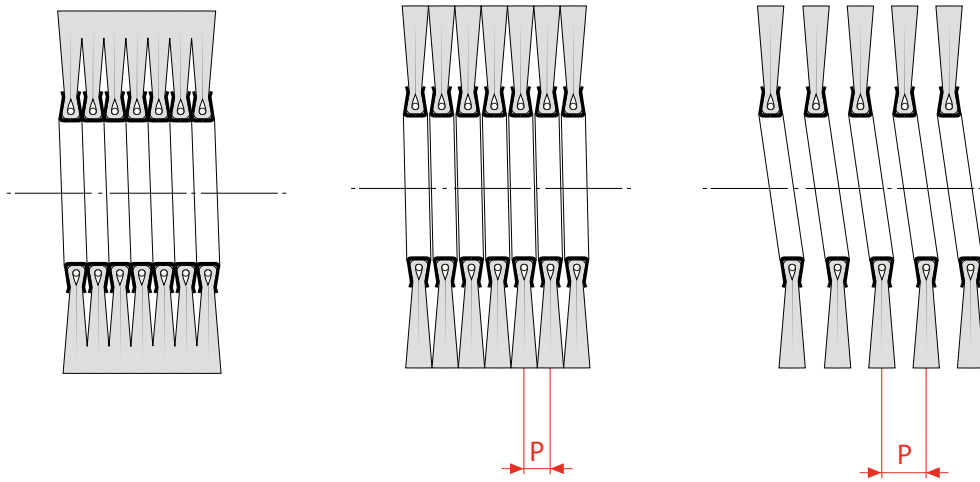

Alta densità (spire accostate)  
High density (closed coils)

Media densità  
Medium density

Bassa densità  
Low density



La direzione di scarico dei residui di materiale spazzolato dipende dall'orientamento degli avvolgimenti, che può essere:

Material will be moved out according to the rotation direction and to the winding orientation that can be:

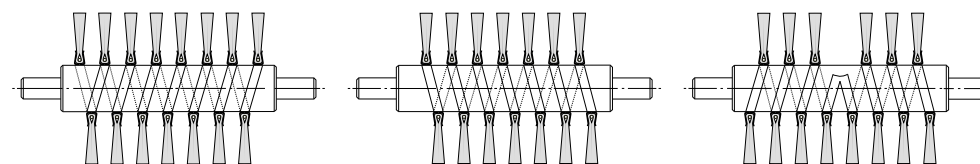

Sinistrorso  
Left-handed

Destroso (standard)  
Right-handed (standard)

Convergente/divergente al centro  
Convergent/divergent to the center

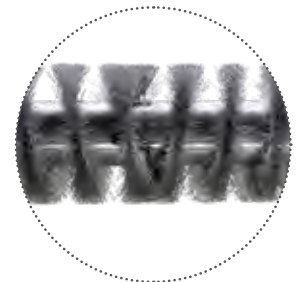

## > Spirali / Spiral brushes

### Velocità di rotazione, tipo di strip e dimensioni / Rotational speed, strip type and size

Lo Strip che costituisce la spirale, può essere di tipo Normale (N) oppure Graffato (G), in base alle esigenze di densità o di velocità di rotazione della spazzola. Una spazzola a spirale composta da strip Normale è indicata per velocità periferiche non superiori ai **15m/s - 2955ft/min**, mentre una spazzola con strip Graffato può sopportare velocità fino a **20m/s - 3940ft/min**.

Strip brushes forming the spiral brush can be Normal (N) or Double band (G) according to the required filling density and peripheral speed. Normal strip is recommended for spirals working at surface speed lower than **15m/s - 2955ft/min**; double-banded strip can withstand higher speed, up to **20m/s - 3940ft/min**.

### Basi utilizzate e minimo diametro di avvolgimento / Assembled bases and winding minimum diameter

BASE		TIPO STRIP STRIP TYPE	DIAMETRO MINIMO / MINIMUM DIAMETER			
mm	inch		Acciaio mm	Steel inch	Inox mm	S-Steel inch
5	3/16	N	14	1/2	18	3/4
10	3/8	N	25	1	40	1-5/8
6	1/4	G	25	1	30	1-1/8
8	5/16	G	40	1-5/8	50	2



### Spirali Elettrosaldate / Electric-Welded Spiral Brushes

Spazzole a spirale a passo accostato possono essere elettrosaldate al loro interno in modo da formare un unico modulo a struttura cilindrica. I moduli, disponibili in diversi diametri, filamenti e sporgenze, si possono interconnettere per ottenere la lunghezza desiderata e sono facilmente intercambiabili.

Spiral brushes with closed coils can be electrically welded inside to create a single cylindrical module. Modules can be assembled to obtain the required length and are easily interchangeable. Available in different diameters, filaments and trim length.



### Tipologie di montaggio / Assembly methods

Le spazzole a spirale possono essere avvolte e opportunamente fissate al nucleo che può essere costituito da **un albero pieno** oppure da un **tubo**; la scelta tra i due sistemi è fatta in base all'applicazione e alle dimensioni della spazzola. Il tipo di strip e il tipo di fissaggio saranno opportunamente studiati dal nostro Ufficio Tecnico in base alle specifiche dell'applicazione.

Spiral brushes can be wound up and properly assembled to a core that can be either a **solid shaft** or a **tube**. The choice between the two systems depends on application and size of the brush. SIT Technical Office will be at customer's disposal for studying the the most appropriate strip and mounting for each specific application

### Tondi e tubi standard utilizzati / Standard shafts and tubes

TONDI / SHAFTS		TUBI / TUBES	
mm	inch	mm	inch
20	3/4	28x1,5	1-1/8x1/16
30	1-1/4	30x1,5	1-3/16x1/16
35	1-1/8	42x2	1-5/8x1/16
40	1-5/8	50x1,5	2x1/16
50	2	60x1,5	2-3/8x1/16
60	2-3/8	70x3	2-3/4x1/8
		80x2	3-1/8x1/16
		102x3	4x1/8
		114x2	4-1/2x1/16
		133x3	5-1/4x1/8
		159x3	6-1/4x1/8
		168x4	6-5/8x1/8
		180x2	7-1/8x1/16
		200x2	7-7/8x1/8
		220x2,5	8-5/8x1/8

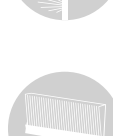
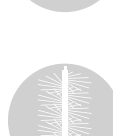

### Montaggio su tondo / Body mounted spiral

La spazzola è montata direttamente su un albero di rotazione. La spirale accostata o a passo, è saldata alle estremità e, una volta consumata, può essere sostituita presso la nostra officina.

The brush, with closed or spaced coils, is mounted directly onto the rotating shaft and both spiral ends are welded. The shaft is re-usable and the brush, once worn out, can be restored in our facility.

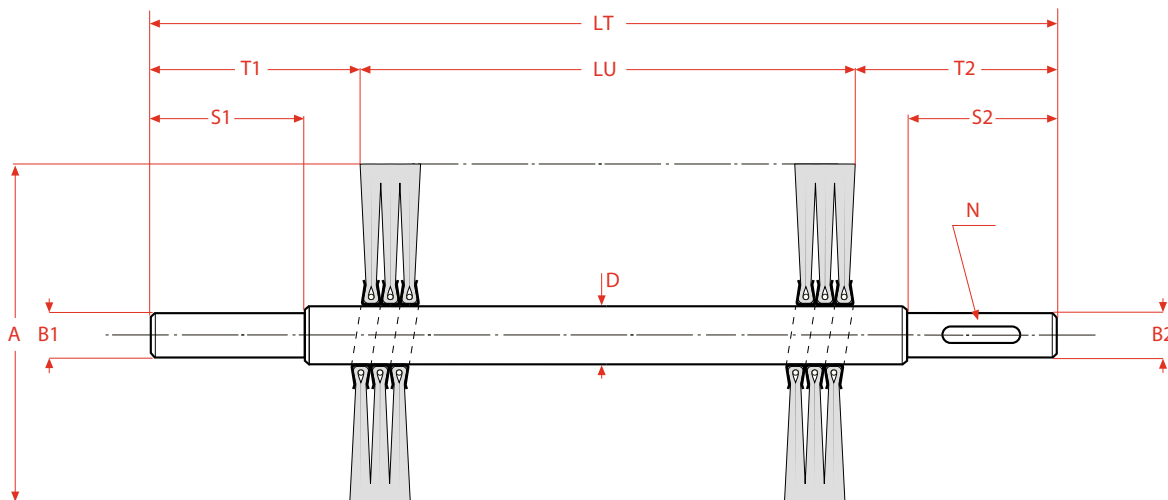

#### LEGENDA

- A** = Diametro esterno / Outer diameter
- D** = Diametro esterno tondo / Shaft outer diameter
- LU** = Lunghezza utile / Useful length
- LT** = Lunghezza totale / Total length
- T1, T2** = Estremità albero / Shaft ends
- S1, S2** = Lunghezza rastremazioni / Tapered sections length
- B1, B2** = Diametro rastremazioni / Tapered sections diameter
- N** = Sede linguetta / Keyway



### Spazzola intercambiabile / Interchangeable brush

Una spirale a passo accostato o elettrosaldata (oppure una serie di anelli) può essere fissata tramite bloccaggio con ghiera filettata mobile e riscontro fisso, rendendo molto semplice la sostituzione

Closed coils or electrical-welded spiral brushes (or single section wheels) can be fixed through a movable threaded lock nut at one side only matched up with a fixed ring nut on the other side. This makes the replacement very fast and easy.

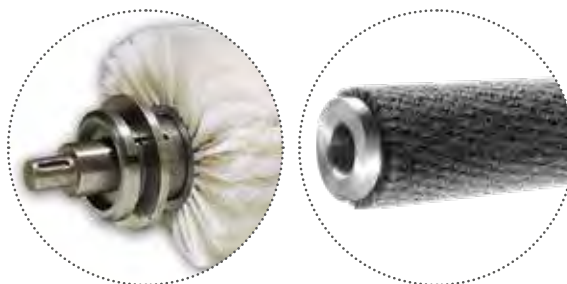
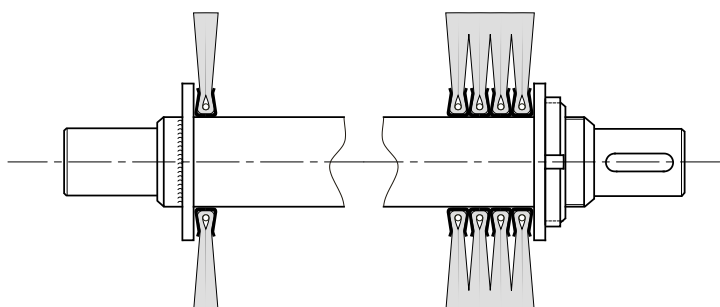

**> Spirali / Spiral brushes**

**Montaggio su tubo / Tube mounted spiral**

La spazzola è montata su un tubo dotato di riduzioni a foro per l'accoppiamento con l'albero di rotazione, oppure di mozzi per supporto e trascinamento.

The brush is mounted on a tube with adapters for coupling with the rotating shaft or with hubs for support and dragging.

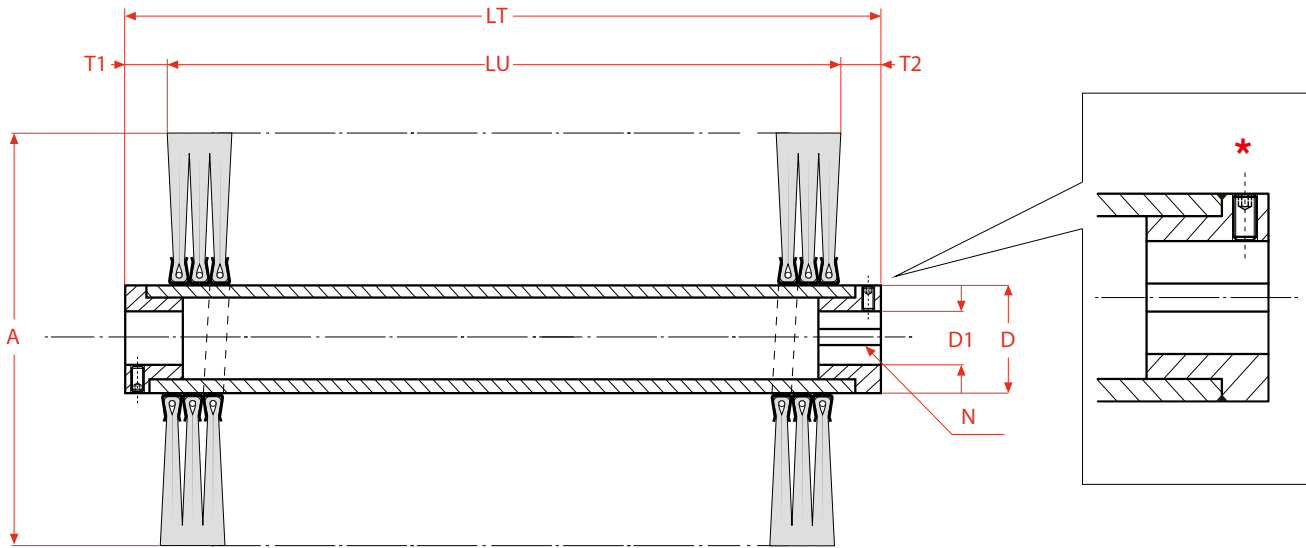

**LEGENDA**

- A = Diametro esterno / Outer diameter
- D = Diametro esterno tubo / Tube outer diameter
- LU = Lunghezza utile / Useful length
- LT = Lunghezza totale / Total length
- T1, T2 = Estremità tubo / Tube ends
- D1 = Diametro foro passante / Cross hole diameter
- N = Sede linguetta / Keyway
- \* = Foro filettato / Threaded hole



**Montaggio su tubo bordato (usa e getta) / Flanged tube mounted spiral**

La spirale (o la serie di anelli) può essere chiusa tra due flange di contenimento bloccate dalla bordatura del tubo (massimo spessore: 2mm - 0,078"); ne risulta una spazzola molto densa ed omogenea.

Spiral brushes or single section wheels can be assembled on a tube and fixed by two flanges (maximal thickness 2mm - 0,078"); The resulting brush is dense and uniform.

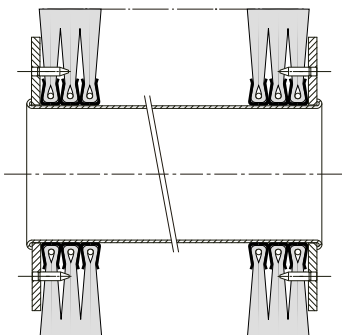



## > Spirali / Spiral brushes

### Equilibratura dinamica / Dynamic balancing

L'equilibratura dinamica delle spazzole è indispensabile per migliorare il rendimento del trattamento superficiale ed evitare sollecitazioni dannose all'impianto di spazzolatura.

Si raccomanda l'equilibratura dinamica per tutte le spazzole montate su nucleo che ruotano ad alta velocità.

SIT può eseguirla al proprio interno in conformità alla norma ISO 1940 (lo standard è g. 6,3. Altri gradi a richiesta) rilasciando i relativi certificati.

*The dynamic balancing of the brushes is very important to improve the performance of the surface treatment and to avoid the brushing machine's stress.*

*Dynamic balancing is strongly recommended for shaft mounted brushes rotating at high speed. We may perform the balancing (ISO 1940 g. 6,3 as standard) and issue the relevant certificate.*



### Rasatura / Trimming

Una particolare rasatura o anche una rettifica nel caso di spazzole in acciaio, permettono di ottenere una cilindricità perfetta. Ne consegue che la superficie della spazzola lavora in maniera uguale ed uniforme su tutta la superficie trattata.

*A special trimming or even a grinding in case of metal wire, generates a perfect cylindricity of the brush with reference to the rotation axis. As a result, the surface of the brush works equally and uniformly on the processed surface.*



### Spazzole cilindriche sagomate / Shaped roller brushes

Per particolari applicazioni e su specifico disegno del cliente, tutte le spazzole cilindriche possono essere sagomate, a prescindere dal tipo di filamento (sintetico, naturale, metallico, misto).

Data la particolare caratteristica di rendimento a seconda del profilo della spazzola, il nostro ufficio tecnico saprà consigliarvi al meglio per il tipo di profilo ed il filamento da utilizzare.

*Roller brushes can be shaped to comply with special applications and in accordance with customer's specific requirements. They can be supplied in every type of filament: synthetic, natural, metallic or mixed.*

*Given the desired performance depending on the profile of the brush, our technical office will provide advice on the best brush for the profile and the filament to be used.*

Esempio applicazioni: Pulizia piste per prefabbricati in fibrocemento, pulizia e oliatura stampi per produzione onduline, applicazione pellicola adesiva a carcassa dei pneumatici.

*Applications: Cleaning of precast fiber cement runs, cleaning and oiling of molds for corrugated profiles production, applying adhesive film to the tire ply.*



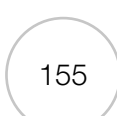

### VANTAGGI DEI RULLI A SPIRALE / SPIRAL ROLLS ADVANTAGES

- Maggiore controllo su densità e rigidezza / *Better control of density and stiffness*
- Totale discrezione per il cliente nella scelta delle dimensioni della spazzola / *Possibility for the customer to choose any brush size*
- Possibilità di regolare il passo della spirale / *Possibility to change coils' pitch*
- Possibilità di agire sul senso di avvolgimento (destra, sinistra o convergente) per direzionare il materiale asportato / *Possibility to steer the removed material by acting on the windings orientation (right, left or convergent/divergent)*
- Possibilità di sagomare con profili a disegno la superficie della spazzola / *Possibility to obtain shaped profiles of the brush upon customer's drawings*
- Possibilità di organizzare presso SIT lo smaltimento della spazzola usurata e la sua ricostruzione mantenendo il nucleo di montaggio (gestione del ciclo di vita del prodotto) / *Possibility to dispose of worn brushes in our plant and replace them maintaining the core shaft (LCA management)*
- Maggiore velocità periferica consentita rispetto alle spazzole punzonate / *Higher peripheral speed than stapled set brushes*

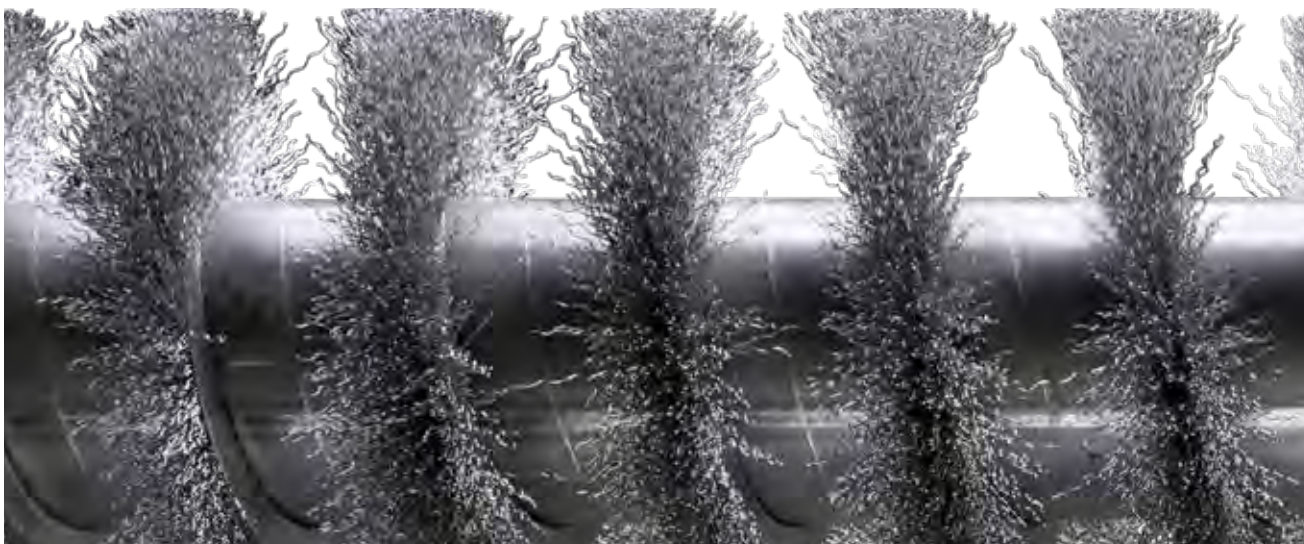

## &gt; Rulli Master / Master Rolls

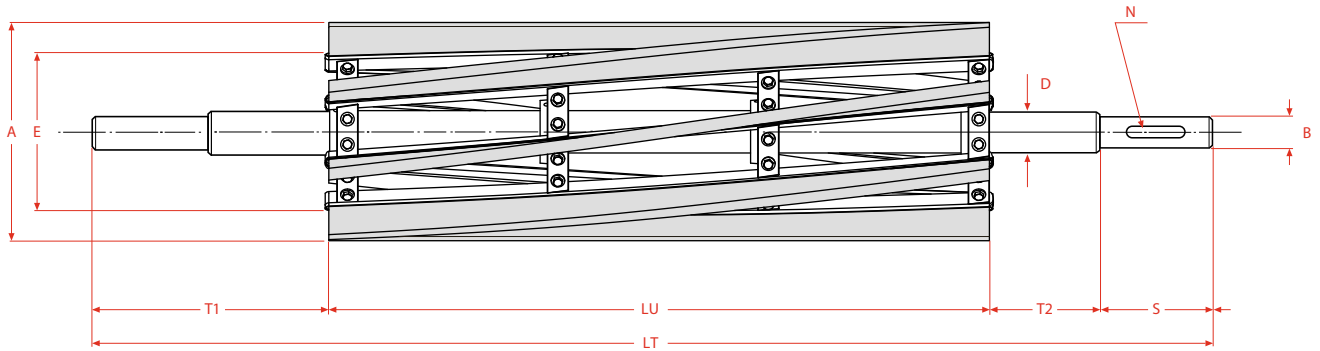

I Rulli "Master" sono **spazzole cilindriche a settori elicoidali** i cui elementi spazzolanti sono strip lineari montati su un albero metallico rotante. La tipologia costruttiva permette una **spazzolatura continua con scarico del materiale "asportato"**.

Master Rolls are **cylindrical brushes with helical sections** having linear strip brushes mounted on a rotating shaft as brushing elements. They allow **continuous brushing with the disposal of waste material**.

## LEGENDA

**A** = Diametro esterno / External diameter

**D** = Diametro esterno albero/tubo / Shank/Tube external diameter

**D1** = Diametro foro passante / Cross-hole diameter

**LU** = Lunghezza utile / Useful length

**LT** = Lunghezza totale / Total length

**E** = Diametro dischi porta strip / Disc bearing strips diameter

**T1, T2** = Estremità albero/tubo / Shaft/Tube end

**S1, S2** = Lunghezza rastremazioni / Tapered sections length

**B1, B2** = Diametro rastremazioni / Tapered sections diameter

**N** = Sede linguetta / Keyways

**MAX SPEED** = Velocità lineare massima (convertire in RPM con tabella a pag. 22) / Maximum surface speed (convert to RPM with table at page 22)



## VANTAGGI DELLA SPAZZOLATURA CON RULLI MASTER / ADVANTAGES OF MASTER ROLLS

Il montaggio elicoidale degli elementi fa sì che una parte della spazzola rimanga sempre a contatto con la superficie da pulire agendo in modo continuo e senza saltellamenti. Questo favorisce inoltre lo spostamento laterale del materiale asportato. La distanza fra gli elementi, o settori, della spazzola infatti consente lo scarico totale del materiale ed evita ogni rischio d'intasamento della spazzola stessa. L'azione spazzolante risulta quindi efficace e ad alto rendimento.

*The helical positioning of the strips is studied so that the brush is always in contact with the surface to be cleaned in order to provide a continuous brushing action without clogging. The distance between the brushing elements allows the side-shifting and the complete discharge of the residues and avoids risk of obstruction of the brush. This solutions make Master Rolls very effective and high performing.*

La scelta del filamento dipende dal materiale da pulire: i filamenti possono essere sintetici, metallici, vegetali e misti. *Filaments can be synthetic, metallic, vegetable or mixed, according to the material to be cleaned.*

La scelta del tipo di Rullo Master sarà in funzione del tipo di applicazione (tipo di superficie da pulire, tipo e quantità del materiale da asportare, ecc...). *The choice of the Master Roll depends on the application (surface to be cleaned, kind and amount of material to be removed ...)*

## > Rulli Master / Master Rolls

### Tipologie di rulli master / Master rolls types

Esistono 2 tipologie di Rulli Master differenziate in base al tipo di applicazione ed alla facilità di montaggio/smontaggio e manutenzione.

**I Rulli Master Aperti (RMA)**, a loro volta distinti in “Leggeri” (RMAL) o “Pesanti” (RMAP), sono costituiti da un albero d'acciaio portante dischi torniti, sui quali vengono applicati gli strip mediante tasselli avvitati agli stessi dischi.

**I Rulli Master Chiusi (RMC)**, sono costituiti da un tubo d'acciaio con riduzioni o mozzi a disegno, a cui vengono saldate le guaine che portano gli strip. I rulli RMC sono più leggeri ma richiedono operazioni di sostituzione strip più impegnative.

There are 2 main types of Master Rolls different for the application and for the ease of assembly/disassembly and maintenance.

**Open Master Rolls (RMA)**, which can be “Light” (RMAL) or “Heavy” (RMAP), are manufactured from a steel shaft with discs. Linear strip brushes are fastened onto these discs through screw dowels.

**Closed Master Rolls (RMC)** are made of linear strip brushes with support tapes welded on a steel tube with adapters or shaft-ends. They are lighter but they require longer time for the replacement of strip brushes.

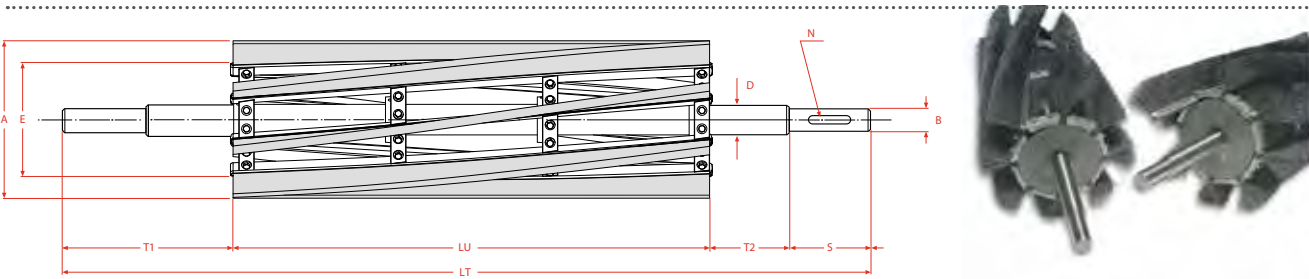

#### RMA

Rulli Master Aperti / Open Master Rolls

	E		LU (min→max)		A (std)		A (min→max)		MAX SPEED	N° strip
	mm	inch	mm	inch	mm	inch	mm	inch		
<b>RMAP</b>	159	6-1/4	200→3000	7-7/8→118-1/8	300	11-7/8	270→450	10-5/8→17-3/4	8 m/s - 1576 ft/min	8 strip base 14
<b>RMAL</b>	80	3-1/8	200→2000	7-7/8→78 3/4	200	7-7/8	180→400	7-1/8→15-3/4	8 m/s - 1576 ft/min	8 strip base 10

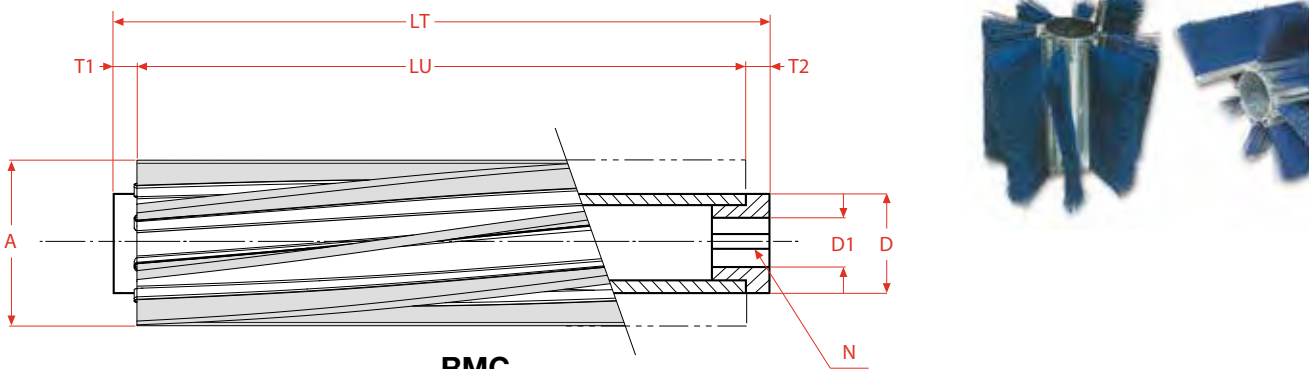

#### RMC

Rulli Master Chiusi/ Closed Master Rolls

	LU (min→max)		A (min→max)		D (min→max)		MAX SPEED	N° strip
	mm	inch	mm	inch	mm	inch		
<b>RMC</b>	200→3000	7-7/8→118-1/8	100→800	4→31-1/2	42→159	1-5/8→6-1/4	8 m/s - 1576 ft/min	su richiesta / on request*

\* In funzione del diametro del nucleo / depending on the tube diameter

### Manutenzione delle spazzole a Rullo Master e sostituzione Strip / Master Rolls maintenance and Strip replacement

Le spazzole a strip sono sfilabili ed intercambiabili con la massima facilità. In tutti i Rulli Master l'operazione di sostituzione è molto semplice e la si effettua senza dover smontare l'albero.

Nel rullo Master aperto è sufficiente allentare le viti che fissano i tasselli a coda di rondine e sfilare le spazzole lateralmente o radialmente secondo le possibilità di accesso. Nei Rulli Master chiusi per sostituire gli strip è sufficiente sfilarli lateralmente dalle guaine dopo averle allentate.

Strip brushes can be easily removed and changed. In any kind of Master Roll the replacement is very simple and can be performed without disassembling the shaft.

In RMA, strip brushes can be pulled out from the side or radially after loosening screws and dowels.

In RMC, strip brushes are just pulled out of the tapes sideways after loosening tapes' ends.



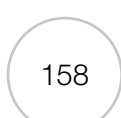
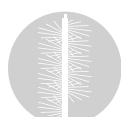

## SOLUZIONI TECNICHE / TECHNICAL SOLUTIONS

### > MODALITÀ COSTRUTTIVE / MANUFACTURING TYPES

# > Spazzole ad Anello / Single Section Wheel Brushes

Gli anelli sono singoli elementi di spazzola di sottile spessore e con qualsiasi tipo di filamento che vengono tendenzialmente assemblati su nucleo metallico.

Questa modalità costruttiva è caratterizzata da un'estrema flessibilità dal punto di vista dell'utilizzatore, il quale montando anelli singoli può regolare l'ampiezza della fascia di spazzolatura.

Le spazzole ad anello possono essere classificate per stile del filo (ondulato o a mazzetti ritorti) quindi per dimensione.

Single section wheels are single "rings" of filament with narrow brushing face made of any type of filament. Usually these single section wheels are stacked onto a metal shaft or tube.

This manufacturing solution has great flexibility since the user can assemble as many wheels as he needs in order to change the assembled roller brush face width.

Single section wheels can have different wire styles (crimped or twisted knots) and different sizes.

## Anelli a filo ondulato / Crimped wire single section wheels

### Applicazioni / Applications

Gli anelli a filo ondulato vengono utilizzati per applicazioni di finitura superficiale leggera di ogni sorta (dalla ricostruzione pneumatica alla sbavatura alla satinatura alluminio alla finitura/spolveratura legno) ma anche per applicazioni secondarie (guarnitura o filtro per fluidi)

Crimped wire wheels are used for light surface finishing operations of any kind (tyre retreading, deburring, aluminium satin finishing, wood finishing/dusting, ...) but also for other special operations (concrete coating, fluid filtering, ...)

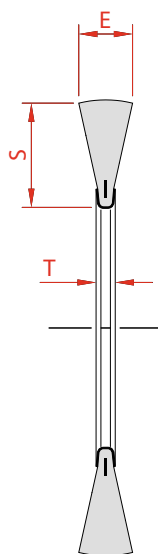
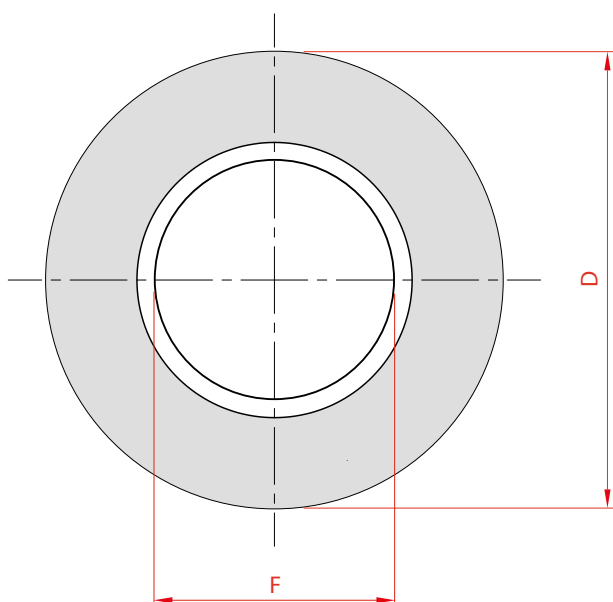
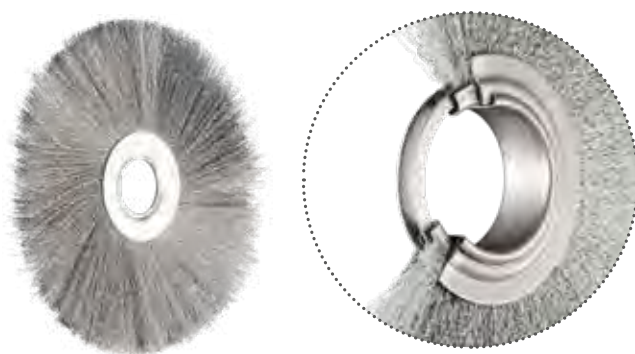

D (min→max)		F		T		E
mm	inch	mm	inch	mm	inch	
25→150	1→5-7/8	6   8	1/4   3/8	4	3/16	>T
26→150	1→5-7/8	10   12   13   14   16	3/8   1/2   9/16   5/8	7	1/4	>T
50→250	2→10	20   22   25	3/4   7/8   1	7,5	5/16	>T
75→300	3→11-3/4	30   40	1-1/4   1-5/8	8,5	5/16	>T
120→350	4-3/4→13-3/4	53   60   80	2-3/8   3-1/8	9	3/8	>T
200→400	7-7/8→15-3/4	103   125	4   5	10,5	7/16	>T
260→400	10-1/4→5-3/4	160   178	6-5/8	13	1/2	>T

### Legenda /

D = Diametro Esterno / Outer diameter

S = Sporgenza / Trim length

Z = n° di mazzetti / Number of knots

F = diametro del foro interno / Inner diameter

E = Spessore della fascia di spazzolatura / Face width

T = Spessore misurato sul foro / Width at the bore

Nota: la quota E è in funzione della tipologia e forma del filamento presente nell'anello

### Anelli a mazzetti ritorti / Twist knot single section wheels

#### Applicazioni / Applications

Ingegnerizzati, a partire dalla flangia, fino ai materiali ed alla tecnica di avvolgimento del filo per applicazioni gravose, soprattutto per l'industria della lavorazione dei tubi.

Single section wheels engineered, starting from the flange, up to the materials and wire knots twisting techniques, for heavy duty applications, especially for the pipeline industry (coating removal).

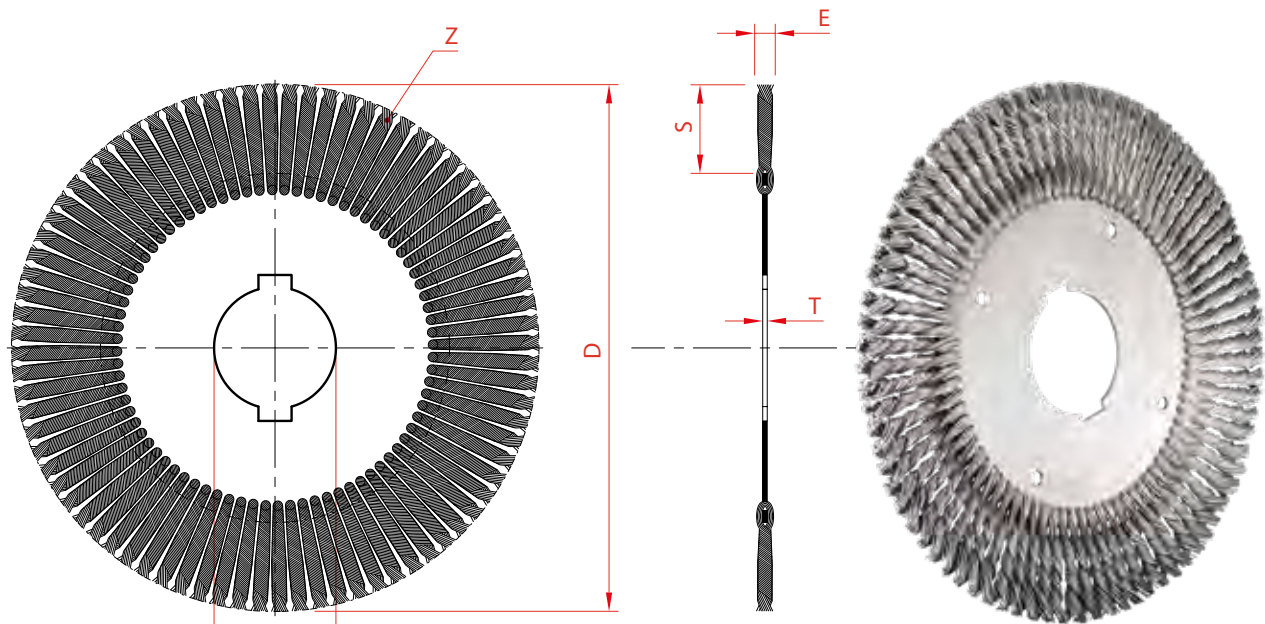

D (min→max)		F		E		Z
mm	inch	mm	inch	mm	inch	
120→180	4-3/4→7-1/8	22,2   26,2   34,5   35,2	7/8   1   1-3/8	15→20	5/8→3/4	24→30
130→220	5-1/8→8-5/8	22,2   26,2   50,2   53	7/8   1   2   2-1/8	20	3/4	32
160→340	6-1/4→13-3/8	22,2   25,4   32   35,5   40,1   65,2   81	7/8   1   1-1/4   1-3/8   1-5/8   2-5/8   3-1/8	15	5/8	40
250→350	9-7/8→13-3/4	22,2   25,4   70   81   83   90,4   102	7/8   1   2-3/4   3-1/8   3-1/4   3-1/2   4	15	5/8	50→55
270→350	10-5/8→13-3/4	35   50,8   51   81   83   89,5   100	1-3/8   2   2   3-1/8   3-1/4   3-1/2   4	20	3/4	64
300→390	11-7/8→15-3/8	35,5   40,5   76,2   81   83   89,5   127   131   155,6	1-3/8   1-5/8   3   3-1/8   3-1/4   3-1/2   5   5-1/8   6-1/8	20	3/4	80
380→480	15→18-7/8	81,1   150   182   192   201	3-1/8   6   7-1/8   7-1/2   8	20	3/4	110→114
500→550	19-3/4→21-5/8	70   251	2-3/4   9-7/8	20	3/4	100→150





### Spazzole a rullo con anelli / Roller brushes with single section wheels

Le spazzole ad anello possono essere assemblate su un nucleo (albero pieno o tubo) accostate per formare una spazzola a rullo. In questa fase di assemblaggio incidono diverse variabili:

Single section wheel brushes can be assembled on a shaft or on a tube, stacked in order to make a roller brush. Many variables can influence this assembly process:

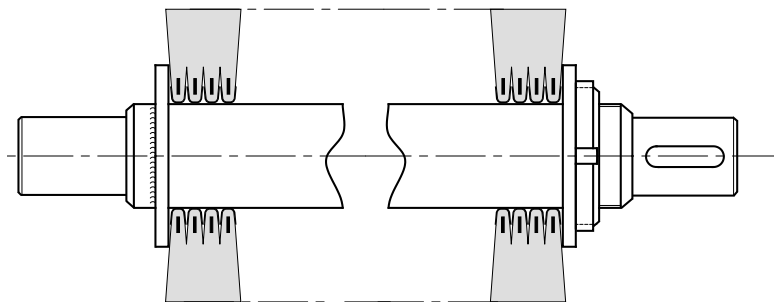

#### Spessore sul foro / Width at the bore

Lo spessore misurato sul foro incide sul livello di accostamento degli anelli quindi sulla foltezza della spazzola quindi sulla finitura superficiale desiderata. Si può diminuire la densità del rullo interponendo dei distanziali tra un anello e l'altro oppure incrementare la densità premendo gli anelli prima della "chiusura" del rullo.

Flanges' width influences the combination of the wheels and the pitch, so the brush density and the type of finishing. Density can be increased by pressing the wheels before locking the roller brush or it can be decreased by using spacers between each wheel.

#### Ghiere di montaggio / Lock nuts

Assemblando anelli su albero si consiglia il fissaggio con ghiera; l'attrito da questa applicato consente eventualmente il trascinarsi della spazzola. Solitamente il nucleo presenta una flangia fissa da un lato ed una flangia mobile pressata dalla ghiera dall'altro lato. Svitata la ghiera e tolta la flangia mobile è possibile inserire o rimuovere gli anelli del rullo.

Le spazzole a rullo con anelli possono essere composte dall'utilizzatore mediante il montaggio dei singoli anelli sul proprio albero, oppure fornite già assemblate da SIT.

Locking nuts are recommended when mounting single section wheels on a tube or shaft. They lock the wheels and they are often used for mounting and dragging the roller brush on the machinery. Usually the shaft has a movable threaded lock nut at one side, to facilitate assembling and disassembling single section wheels, and a fixed ring nut on the other side.

This kind of roller brushes can be created directly by the user assembling single section wheels on his shaft or can be supplied already assembled by SIT.

#### Sistemi di trascinamento / Dragging

In caso di elevate pressioni d'esercizio ed elevate velocità di rotazione si possono prevedere sistemi di trascinamento per evitare il rischio di slittamento degli anelli durante la spazzolatura. Tra questi sistemi:

With high working pressure and high rotational speed, dragging systems are recommended so that single section wheels don't slip or slide on the shaft while brushing. Among these brushing systems:



Pizzicatura in rilievo / Beaded stapling



Perno / Pins



Chiavetta / Keyways



#### VANTAGGI DEI RULLI AD ANELLI / ADVANTAGES OF ROLLER BRUSHES MADE OF SINGLE SECTION WHEELS

- Facile intercambiabilità / *Easily interchangeable*
- Possibilità di selezionare le spazzole da sostituire (singoli anelli e non rullo intero) / *Chance to choose and change even only one single section wheel (not the whole roller)*
- Possibilità di creare una spazzola sagomata utilizzando anelli di diametro esterno differente / *Chance to create a shaped roller brush by using single section wheels with different outer diameters*
- Maggiore velocità periferica consentita rispetto alle spazzole a spirale / *Higher allowed peripheral speed than spiral brushes (and even higher than stapled set brushes)*
- Possibilità di condurre test di applicazione in fase di sviluppo e prototipi assemblando solo pochi anelli invece che avere l'intera spazzola a rullo / *Chance to perform tests for the application by getting only a few wheels instead of getting a whole roller/spiral brush.*

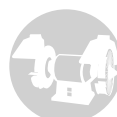

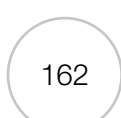
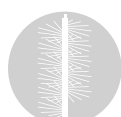

## > MODALITÀ COSTRUTTIVE / MANUFACTURING TYPES

# > Spazzole composite e sbavatura di metalli duri / Composite brushes and hard metal deburring

SIT ha stretto una partnership con Tanis, produttore di spazzole americano con una forte esperienza in utensili per sbavatura ed applicazioni di finitura superficiale.

Le spazzole Tanis in nylon abrasivo CeramiX® sono ingegnerizzate per l'utilizzo con elettrotensile, in celle robotizzate e in macchine a controllo numerico con lo scopo di eliminare lo spreco e la non standardizzazione di operazioni di sbavatura manuale. L'accesso esclusivo di SIT alla gamma di prodotti di Tanis, con forte concentrazione su filamenti abrasivi speciali, amplia l'offerta di spazzole industriali disponibili per i nostri clienti.

SIT has partnered with Tanis, a US brush manufacturer with a strong expertise in flexible filing tools for deburring and surface conditioning applications.

Tanis CeramiX® abrasive nylon brushes are designed for use in power tools, robotic cells and CNC applications to eliminate the need for time-consuming and inconsistent hand deburring operations. SIT's exclusive access to Tanis' product catalog expands the industrial brush offering available to our customers with a strong focus on special abrasive filaments like ceramic and diamond abrasive nylon.



Rispettare i limiti di velocità di rotazione MAX RPM con riferimento, per i prodotti del presente capitolo, ANSI 3.1.8, ANSI B165.1 e B165.2  
Observe speed restrictions MAX RPM in accordance with (for products in this chapter) ANSI 3.1.8, ANSI B165.1 e B165.2



### Materiali / Materials

Queste spazzole in nylon abrasivo sono fatte con filamento CeramiX® fuso in una base composita uretanica.

Il CeramiX® permette un'azione di taglio dalle 3 alle 5 volte più rapida dei filamenti abrasivi tradizionali. Il minerale abrasivo si frantuma perdendo frammenti più piccoli e rimanendo fruibile nel filamento fino a sua completa usura.

Ci sono 3 caratteristiche chiave che contribuiscono alla performance elevata di questo filamento:

- **Resistenza a frattura / fracture resistance**
- **Durezza / hardness**
- **Auto-affilatura / self-sharpening qualities**

These abrasive nylon brushes are made with CeramiX® abrasive filament molded into a urethane based composite hub construction. CeramiX® provides enhanced cutting action up to 3 to 5 times faster than traditional abrasive filaments. The mineral wears away in smaller pieces, consistently leaving more mineral in the filament to work on the part surface.

There are three key traits which contribute to this filament's performance:



Frattura abrasivo Sol-Gel / Sol-Gel abrasive fracture



Frattura abrasivo ceramico speciale / Special ceramic filament fracture

Tali caratteristiche comportano l'incremento di performance delle spazzole in nylon abrasivo CeramiX® prodotto con grana abrasiva ceramica 321 di proprietà 3M™ (disponibile in grana 320, 220, 180, 120, 80 e 46) inglobata all'interno del filamento.

These features equate to increased productivity and lower cost of ownership; CeramiX® abrasive nylon brush filaments are made with proprietary 3M™ 321 ceramic abrasive grain (available in 320, 220, 180, 120, 80 and 46 grit



**Test 1:  
Piastra di alluminio /  
Aluminium plate  
1750 RPM**

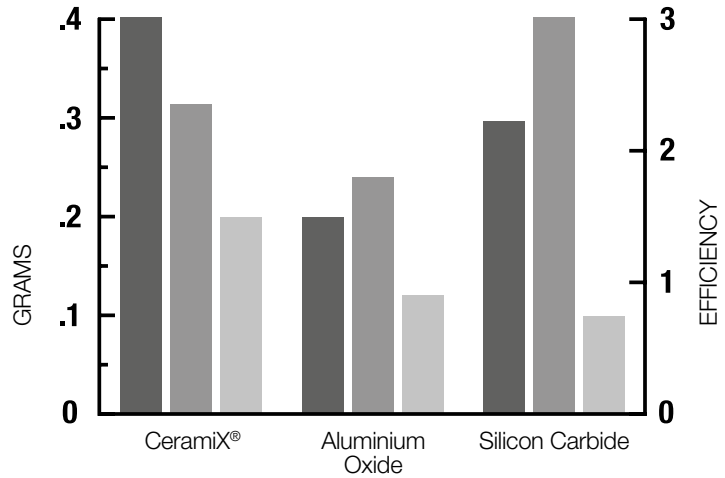

**Test 2:  
Piastra di acciaio laminato a freddo /  
CRS Plate  
1750 RPM**

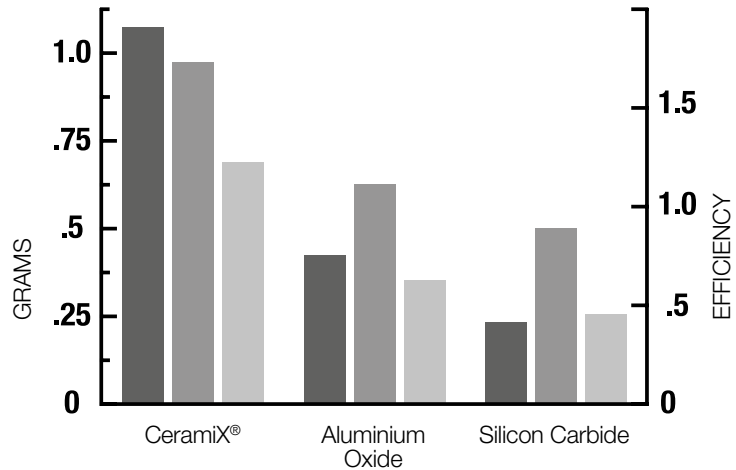

- Materiale asportato / Cut [g]**
- Filamento consumato / Wear [g]**
- Efficienza / Efficiency (Cut/Wear)**

**Grana e diametro del filamento / Grit size and filament diameter**

Grana Grit	Diametro filamento / Filament diameter	
	mm	inch
46	1,65 x 2	0,065" x 0,080"
	1,7 x 2,3	0,068" x 0,090"
80	1	0,040"
	1,4	0,055"
120	1,1 x 2,3	0,045" x 0,090"
	0,7	0,028"
180	1	0,040"
	0,9	0,035"
220	0,55	0,022"
320	0,55	0,022"

**Conversione Grana - Micron - Pollici / Conversion chart Grit size - Microns - Inches**

Grana Grit Size	Micron	Inches
	(valore medio / average)	
46	356	0,014
60	254	0,010
80	165	0,0065
100	122	0,0048
120	102	0,0040
180	76	0,0030
220	63	0,0025
240	50	0,0020
320	31	0,00122
400	22	0,00087"
500	19	0,00075
600	16	0,00063"
800	12	0,00047
1000	7	0,00028

Ogni grano abrasivo ha una dimensione differente. In tabella si riporta un valore medio / Each abrasive grain has a different dimension. In table the average value is provided.

I filtri standard forniti per macchinari CNC (carta, tessuto, viscosa, feltro) sono studiati per filtrare particelle fino a 5 micron - 0.0002". Rivolgersi al fornitore per la scelta del filtro più opportuno.

Standard CNC filters (paper, cloth, viscose, felt) will filter up to 5 micron - 0.0002" particles. Ask your supplier for the proper filter.





### Spazzole a disco / Disc brushes

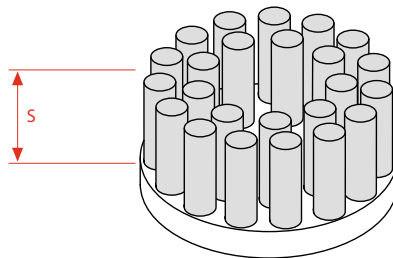
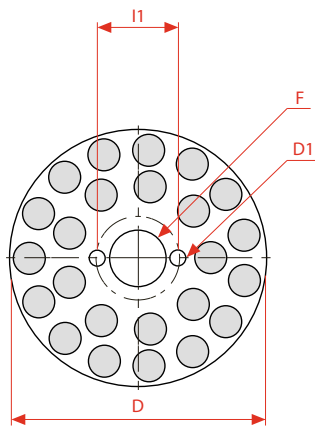

Pattern punzonato / Tufted pattern

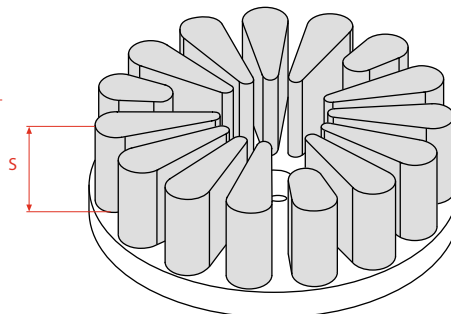
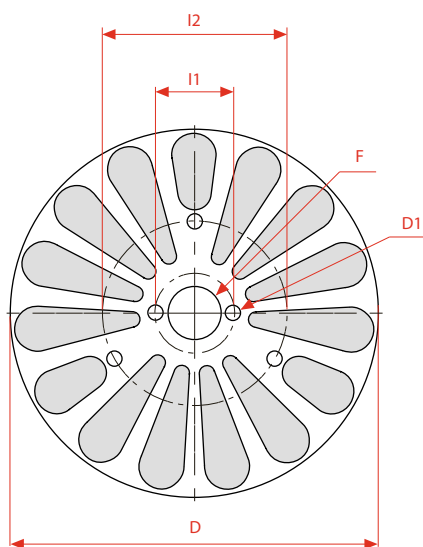

Pattern a goccia / Teardrop pattern



FLEXIBILITY

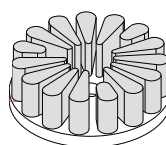

AGGRESSIVENESS

Le spazzole composite a disco costituiscono un utensile spazzolante robusto e ad alta efficienza. Maggiori densità di filamento consentono una spazzolatura più aggressiva e rendono la spazzola ideale per la massima produttività. Sono disponibili differenti pattern di filamento per applicazioni che richiedono massima densità (pattern a goccia) o minore densità (pattern punzonato) o con configurazioni particolari.

The disc brush's composite molded construction creates a tough, high-productivity brush tool. Higher fill densities allow for a more aggressive brush, making this brush capable of maximized productivity. Alternative filament patterns are available for applications requiring maximum density (teardrop pattern) or lighter filament density (tufted pattern) or with peculiar patterns.

D		F		S		MAX RPM	Tipo adattatore Drive arbor type
mm	inch	mm	inch	mm	inch		
76	3	22	7/8	38	1-1/2	2500	50
102	4	22	7/8	38	1-1/2	2500	50
127	5	22	7/8	38	1-1/2	2500	50
152	6	22	7/8	38	1-1/2	2000	55, 60
203	8	22	7/8	38	1-1/2	2000	65
254	10	22	7/8	38	1-1/2	1750	70
305	12	22	7/8	38	1-1/2	1750	70
355	14	22	7/8	38	1-1/2	1500	70

Le quote D1, I1 e I2 dei fori di interfaccia sono specificate a pag. 161 / D1, I1 and I2 mounting interface dimensions are specified at page 161

## > Spazzole composite / Composite brushes

### Mini spazzole a disco / Mini disc brushes

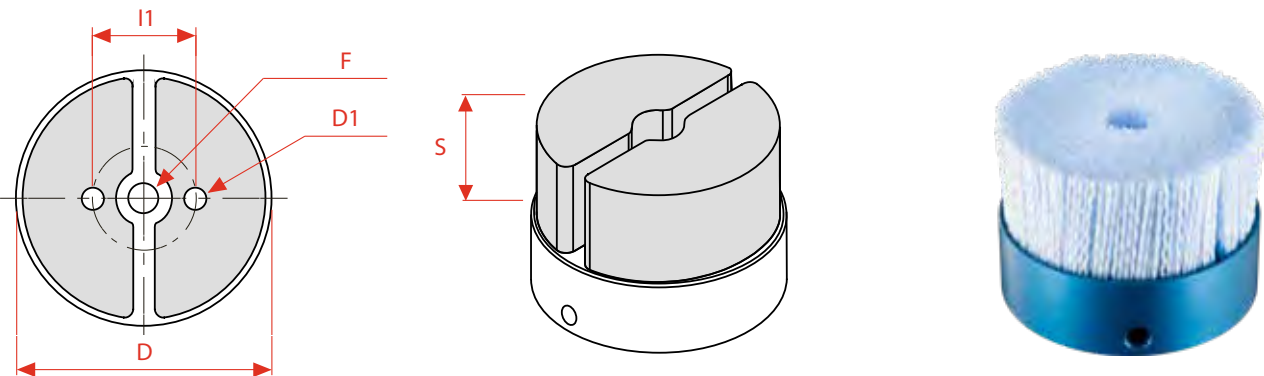

D		F		S		MAX RPM	Tipo adattatore Drive arbor type
mm	inch	mm	inch	mm	inch		
51	2	10	3/8	32	1-1/4	4500	48
76	3	10	3/8	32	1-1/4	4500	48

Le quote D1, I1 dei fori di interfaccia sono specificate a pag. 161 / D1, I1 mounting interface dimensions are specified at page 161

Le spazzole a disco di diametro più piccolo sono caratterizzate da un nucleo di alluminio e da una densità di filamento elevatissima che le rende ideali per sbavare e per omogeneizzare una finitura superficiale

*Ideal for deburring or improving surface finish, these small-diameter disc brushes have an aluminium hub and feature a very high filament density.*

### Alberi adattatori / Drive arbors

Supporti utilizzati per montare in sicurezza le spazzole a disco e mini-disco in macchine fresatrici o CNC. Il gambo del supporto è di 13mm - 1/2" (mini) o di 19mm - 3/4" (normali) per l'utilizzo su ogni mandrino porta utensile. Gli adattatori prevedono un foro passante per la distribuzione del fluido refrigerante.

*Used to securely mount disc and mini disc brushes for use in any type of milling machine or CNC machine. Drive arbor shaft is 13mm - 1/2" (mini) or 19mm - 3/4" (normal) diameter for use in any tool holder. Drive arbors have a through hole for coolant.*

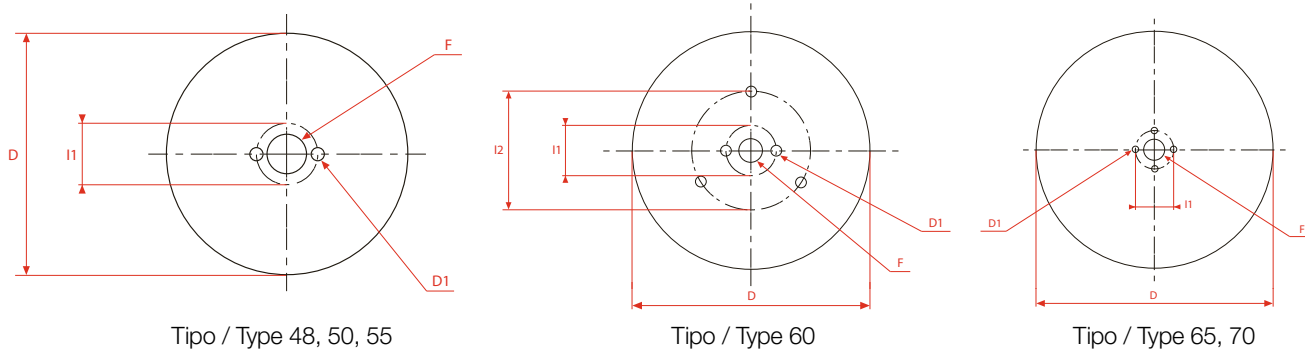

Ref	Tipo adattatore Drive arbor type	Diametro spazzola Brush diameter		Gambo / Shaft		Perni di centraggio / Locating pins	D1		I1		I2	
		mm	inch	mm	inch		mm	inch	mm	inch	mm	inch
0587	48	51, 76	2, 3	12	1/2	2	10	3/8	28,6	1-1/8		
0578	50	76, 102, 127	3, 4, 5	19	3/4	2	3,17	1/8	31,75	1-1/4		
0579	55	152	6	19	3/4	2	3,17	1/8	31,75	1-1/4		
0580	60	152	6	19	3/4	3	3,17	1/8	31,75	1-1/4	76,2	3
	65	203	8	19	3/4	4	3,17	1/8	31,75	1-1/4		
	70	254, 305, 355	10, 12, 14	19	3/4	4	3,17	1/8	31,75	1-1/4		

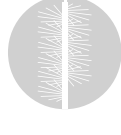



## > Spazzole composite / Composite brushes

### Spazzole a disco per mandrino porta fresa / Shell mill holder disc brushes



Le spazzole a disco per mandrino porta fresa sono spazzole solide ingegnerizzate per una precisione dimensionale superiore. Il filamento CeramiX® determina un'azione abrasiva eccezionale per le applicazioni di sbavatura di superfici piane, migliora la finitura su componenti fresati o comunque lavorati di macchina e raggia spigoli su componenti precedentemente lavorati. Queste spazzole a disco hanno inglobate nella base composita le interfacce e le sedi linguette per il montaggio su mandrini porta fresa standard\* per l'utilizzo in centri di lavoro a controllo numerico.

Shell mill disc brushes provide a consistent, flat brush for superior dimensional precision. CeramiX® abrasive filament provides exceptional abrasive action in deburring applications on flat surfaces, improving metal finish on milled and machined surfaces as well as blending rough edges on machined parts. Shell mill disc brush has built-in keyway to mount directly to a standard shell mill holder\* for use in CNC machining centers.

D		F		S		MAX RPM
mm	inch	mm	inch	mm	inch	
51	2	19	3/4	38	1-1/2	2500
76	3	19	3/4	38	1-1/2	2500
102	4	32	1-1/4	38	1-1/2	2500
152	6	32	1-1/4	38	1-1/2	2500
203	8	32	1-1/4	38	1-1/2	2000
254	10	32	1-1/4	38	1-1/2	2000

\* Mandrino portafresa standard ISO 40 DIN 69871 SEM, DIN 69893 HSK e ISO 50 DIN 69871

\* Standard shell mill holder ISO 40 DIN 69871 SEM, DIN 69893 HSK and ISO 50 DIN 69871

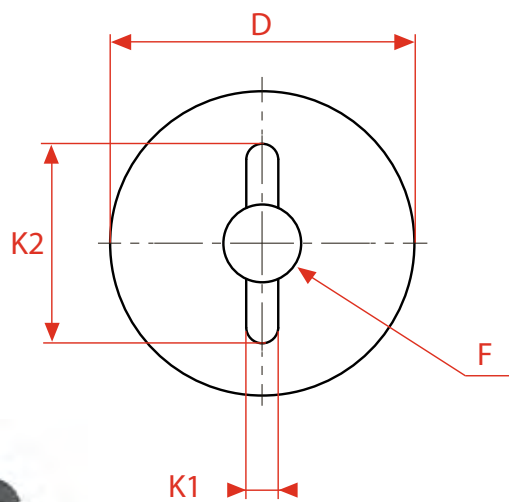

**K1** = 7,94mm - 5/16", 10mm - 3/8"  
**K2** = 51mm - 2", 80mm - 3-1/8"



#### APPLICAZIONI DELLE SPAZZOLE A DISCO / DISC BRUSHES APPLICATIONS

- Sbavare componenti stampati
- Sbavare componenti settore aeronautico
- Sbavare componenti fresati frontalmente
- Smussare segni di rettifica
- Migliorare la finitura superficiale
- Sbavare e rifinire cerchioni in alluminio (grana 46)

- Cast part deburring
- Aircraft components
- Deburring face-milled parts
- Blending grinding marks
- Improving surface finish
- Deburring and finishing aluminum wheel rims (grit 46)



### Spazzole circolari / Wheel Brushes

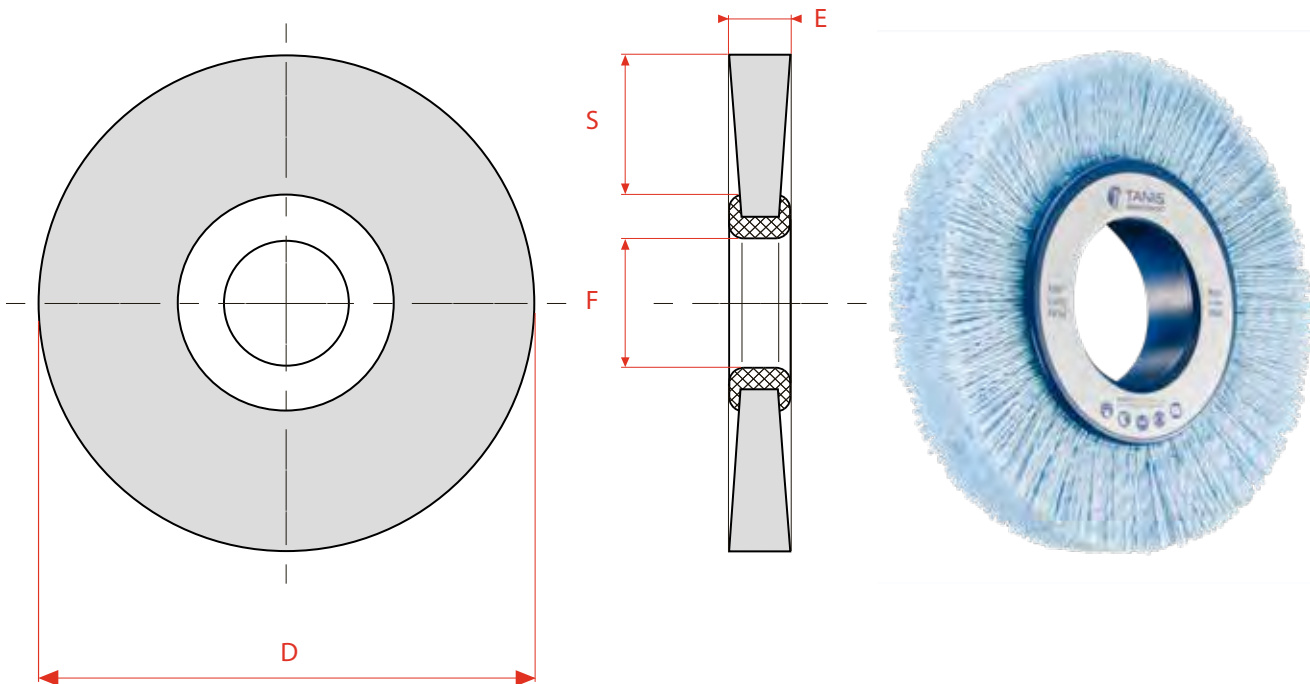

Queste spazzole circolari sono composte da filamento CeramiX® inglobato in un nucleo composto uretanico. Permettono di ottenere una finitura superficiale costante con un'azione abrasiva superficiale controllata ed una bassissima usura di filamento.

Wheel brushes are made with CeramiX® abrasive nylon filament molded into a urethane based composite hub construction. They provide a consistent finish with controlled surface abrading action and low filament breakage.

D		F		E		S		MAX RPM	Tipo Type
mm	inch	mm	inch	mm	inch	mm	inch		
76	3	10	3/8	3	1/8	25	1	10000	Narrow
76	3	10	3/8	6	1/4	25	1	10000	Narrow
76	3	10	3/8	10	3/8	25	1	10000	Narrow
76	3	16	5/8	6	1/4	25	1	10000	Narrow
102	4	16	5/8	6	1/4	25	1	10000	Narrow
102	4	16	5/8	12	1/2	25	1	10000	Narrow
127	5	16	5/8	6	1/4	38	1-1/2	6000	Narrow
127	5	16	5/8	12	1/2	38	1-1/2	6000	Narrow
152	6	16	5/8	6	1/4	51	2	6000	Narrow
152	6	16	5/8	12	1/2	51	2	6000	Narrow
152	6	51	2	25	1	32	1-1/4	3600	
152	6	51	2	51	2	32	1-1/4	1200	Wide
203	8	51	2	25	1	32	1-1/4	3600	
203	8	51	2	25	1	57	2-1/4	3600	
203	8	51	2	51	2	57	2-1/4	1200	Wide
254	10	51	2	25	1	38	1-1/2	3600	
254	10	51	2	25	1	82	3-1/4	3600	
254	10	51	2	51	2	82	3-1/4	1200	Wide
305	12	51	2	25	1	38	1-1/2	1800	
305	12	51	2	25	1	76	3	1800	
305	12	108	4-1/4	25	1	76	3	1800	
355	14	51	2	25	1	38	1-1/2	1800	
355	14	51	2	25	1	89	3-1/2	1800	
355	14	133	5-1/4	25	1	89	3-1/2	1800	



**Narrow** = Le spazzole circolari di spessore ridotto sono utilizzate per applicazioni di pulizia, lucidatura e sbavatura in piccole fessure, scanalature fresate, sbavature fini di strumenti medicali e scanalature negli ingranaggi.

Narrow face wheel brushes are used for cleaning, polishing and deburring recessed applications such as small openings, slots, machined grooves, fine deburring on medical instruments and gear splines.



**Wide** = Con lo spessore raddoppiato queste spazzole circolari permettono una spazzolatura per fasce più ampie in modo da migliorare efficacia ed efficienza in caso di lavori su grandi superfici.

With the double brush width, the CeramiX® wide face wheel brush covers more surface area. Use to increase reach and efficiency for larger jobs. The extra wide brush face allows for greater surface cleaning.





## > Spazzole composite / Composite brushes

### Adattatori / Adapters

Gli adattatori metallici sono utilizzati per montare le spazzole circolari abrasive su alberi di trascinamento di diametro inferiore al foro (da 1/2" a 2"). Vendute come kit, sono disponibili per circolari di diametro interno 51mm - 2" ma anche 133mm - 5-1/4" e 108mm - 4-1/4".

Oltre a queste è disponibile un nuovo set di adattatori ingegnerizzato per il montaggio di qualsiasi circolare su mandrino portafresa (di macchinari CNC e non solo).

*Slip-fit metal adapters are used for mounting nylon abrasive wheel brushes into smaller shafts (from 1/2" to 2"). Sold as a set. Available for 108mm - 4-1/4" and 133mm 5-1/4" brush I.D. wheels and 51mm - 2" brush I.D. wheels.*

*In addition to these, a new set of adapters has been designed for shell mill holder mounting (CNC machines).*



### APPLICAZIONI DELLE SPAZZOLE CIRCOLARI / WHEEL BRUSHES APPLICATIONS

- Sbavare fessure, scanalature e tracce di fresa
- Sbavare ingranaggi (profili dentatura)
- Levigare e rifinire fori cilindrici
- Sbavare il tagliente di punte da trapano in metallo duro
- Sbavare fori incrociati nelle sedi dei cuscinetti
- Raggiare spigoli
- Finitura delle scanalature di punte da trapano in metallo duro post coating
- Sbavare sedi delle tenute nel blocco motore e piccole parti di aereo
- Finitura superficiale palette di turbina
- Deburring keyways, slots and machine grooves in parts
- Deburring gear splines
- Honing and finishing of cylindrical bores
- Hone drill point lip edge on carbide drills
- Deburring cross holes in large bearing bores
- Edge radiusing
- Polishing flutes on carbide drills following post coat process
- Deburring seal grooves in turbine engine cases and small aircraft parts
- Turbine blade surface finishing

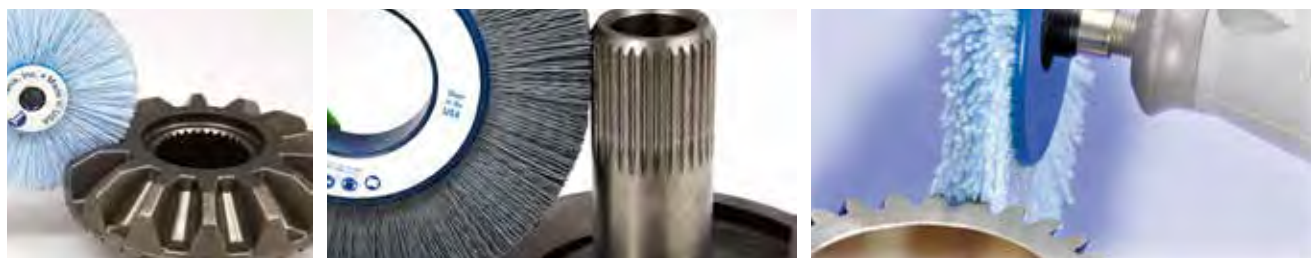

### Parametri Operativi / Operating Parameters

#### Velocità iniziali e Taglia motore / Starting RPM and Motor size

##### Spazzole a disco / Disc brushes

##### Spazzole circolari / Wheel brushes

Spazzole a disco / Disc brushes			Spazzole circolari / Wheel brushes				
D		Dry RPM*	Motor	D		Dry RPM*	Motor
mm	inch			mm	inch		
50	2	1750 - 2500	1/4 HP				
76	3	1750 - 2500	1/4 HP				
102	4	1750 - 2500	1/4 HP	102	4	2000 - 3000	1/4 HP
127	5	1500 - 1750	1/4 HP	127	5	2000 - 3000	1/4 HP
152	6	1250 - 1750	1/2 HP	152	6	1500 - 2000	1/2 HP
203	8	800 - 1200	3/4 HP	203	8	1200 - 1500	3/4 HP
254	10	700 - 800	1 HP	254	10	1000 - 1200	1 HP
305	12	600 - 700	1 HP	305	12	800 - 1000	1 HP
355	14	500 - 600	1 HP	355	14	800 - 900	1 HP

#### Legenda

**D** = Diametro disco o circolare / Disc or wheel diameter

**Dry RPM** = Velocità iniziale raccomandata per applicazioni a secco / Recommended starting RPM for dry applications

**Motor** = Taglia motore raccomandata in cavalli (considerando una fascia di spazzolatura di 25mm - 1") / Recommended motor size horse power (based on a 25mm - 1" brush face)

\* Per applicazioni con fluido refrigerante si possono raggiungere velocità fino al 40% superiori compatibilmente con il massimo valore RPM consentito dalla spazzola e dall'utensile. / RPM for wet application (use of coolants) can be up to 40% more than the dry RPM value, compatibly with the brush and the tool's MAX RPM rated value.

#### Velocità di avanzamento su diversi materiali / Feed rate on different materials

	Velocità Avanzamento / Feed Rate	
	mm/min	in/min
<b>Acciaio Inox - Leghe d'acciaio / Stainless Steel - Alloy Steel</b>	300→450	12→18
<b>Acciaio dolce - Ghisa / Mild Steel - Cast Iron</b>	630→760	25→30
<b>Alluminio - Non ferrosi / Aluminium - Non ferrous</b>	890→1270	35→50

Le spazzole a disco in nylon abrasivo lavorano meglio con velocità che permettono una buona penetrazione dei filamenti sul pezzo. Velocità superiori non lavorano altrettanto bene rispetto a velocità più moderate ed il valore MAX RPM mostrato sulla spazzola non indica la velocità di lavorazione ottimale. Una buona regola è mantenere una velocità tangenziale inferiore ai 13 m/s - 2500 ft/min in applicazioni a secco ed inferiore ai 18 m/s - 3500 ft/min con fluido refrigerante.

Il fluido refrigerante è sempre consigliato in caso di applicazioni ad alte velocità di rotazione, per elevate penetrazioni o per lavorazione su spessori sottili.

#### Verso di rotazione / Rotational direction:

Nella passata iniziale la spazzolatura deve avere, rispetto all'utensile da taglio che ha creato la bava, stessa rotazione e direzione di avanzamento opposta.

Abrasive nylon disc brushes work best at speeds allowing fairly deep penetration of the workpiece into the brush filaments. Faster speeds do not typically work as well as slower speeds, since the maximum RPM listed on the brush is not the optimum working speed. A good rule of thumb is to stay below 13 m/s - 2,500 ft/min in dry applications and 18 m/s - 3,500 ft/min with coolant.

Coolant is always recommended for applications requiring high speeds, high penetration and are used on very thin parts.

On the initial pass, the brush should have same rotation but opposite direction of the cutting tool that created the burr.

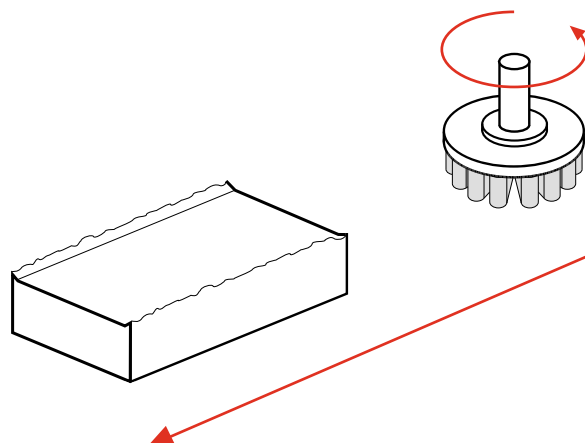



## > Spazzole composite / Composite brushes

### Traiettoria della spazzola / Brush path:

Il percorso ideale della spazzola è quello di direzione opposta rispetto all'utensile da taglio che ha creato la bava.

La traiettoria deve anche essere più ampia di quella dell'utensile da taglio facendo in modo che il punto di uscita della spazzola cada oltre la fine del pezzo.

La spazzola inizia la rotazione prima di toccare il pezzo e termina la rotazione dopo essere uscita dal pezzo.

The ideal brush path is in the opposite direction of travel from the cutting tool that created the burr. The brush path should also be longer than the cutting tool path, to a point where the trailing edge of the brush is effective on the end of the part.

The brush should start and finish its path and rotation completely off the workpiece.

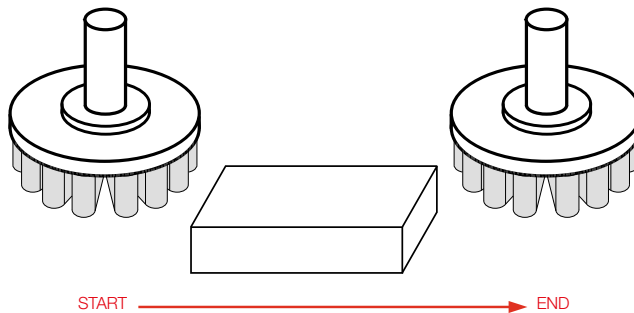

Infine per massimizzare la quantità di filamento a contatto con il pezzo, l'asse di rotazione della spazzola deve essere sfasato rispetto all'asse longitudinale del pezzo, soprattutto se il pezzo è più grande della spazzola.

To maximize the amount of filament that is striking the part, the centerline of the brush should be offset from the center of the part (most important if the piece is bigger than the brush).

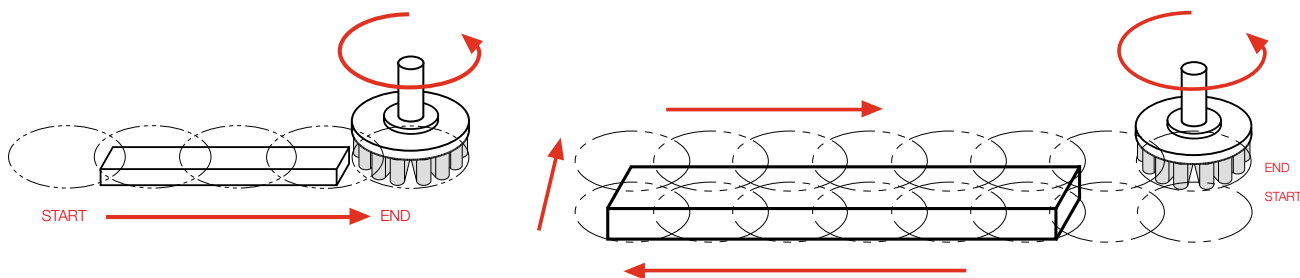

Terminato il primo percorso è consigliabile invertire il senso di rotazione ed impostare una traiettoria opposta alla prima per rimuovere ogni bava.

Once the first path is finished it's recommended to change rotational direction and set a new path opposite to the first one in order to remove any burr left.

### Penetrazione (punto di contatto) / Penetration (point of contact)

L'azione abrasiva ottimale si verifica quando le punte del filamento scorrono sulla superficie o sullo spigolo del componente da lavorare. Il corretto bilanciamento tra velocità (RPM), interferenza/penetrazione, tempo di permanenza e dimensione della grana abrasiva permette di massimizzare la vita della spazzola e la performance di taglio. La penetrazione/interferenza raccomandata per le spazzole circolari e a disco in nylon abrasivo varia da 1.3mm - 0.05" a 2.5mm - 0.10". Queste consentono di massimizzare la vita utile della spazzola e la sua aggressività.

The abrasive action occurs when the sides of the brush filament slide across the part surface or edge of the part. When the correct balance between speed (RPM), penetration, dwell time and abrasive grit size are achieved, then optimum life and cut can be obtained. Recommended penetration rates for abrasive nylon disc brushes and wheel brushes are from 1.3mm - 0.05" to 2.5mm - 0.10". This will lead to long brush life with aggressive abrasive action.

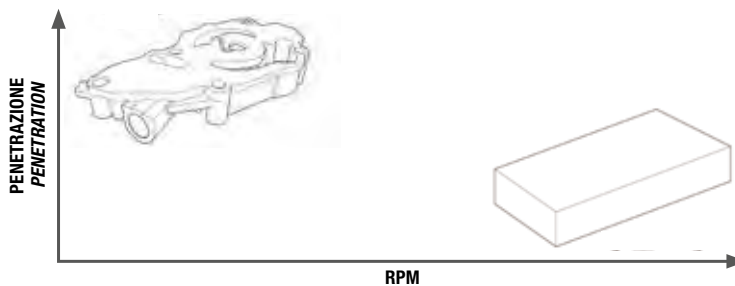

## > Spazzole composite / Composite brushes

### Regolare il consumo del filamento / Filament wear compensation

Come accennato nella sezione "Scelta della spazzola giusta", in macchine a controllo numerico è possibile monitorare il carico sui motori per regolare la posizione dell'utensile al fine di mantenere un'interferenza o una pressione costanti per una migliore performance nella lavorazione ed un minore consumo del filamento. Ci sono 4 metodi diffusi per regolare il consumo di filamento in questi macchinari.

- Indicizzazione automatica: programmare una regolazione (indicizzare l'utensile sull'asse Z) dopo un predeterminato numero di pezzi prodotti
- Ispezione: i centri di lavoro possono avere la capacità di sondare la superficie della spazzola al fine di regolare l'interferenza giusta tra le punte del filamento ed il pezzo da lavorare
- Monitoraggio assorbimento elettrico: attraverso la lettura della corrente nominale con amperometro è possibile regolare la pressione dell'utensile
- Indicizzazione manuale: dove altri metodi non possono essere utilizzati l'operatore può intervenire per regolare manualmente l'interferenza in base a metodi di controllo statistico o di controllo visivo sui pezzi lavorati

As referred in the "How to choose the right brush" section, on CNC machinery it's possible to monitor the load on drive motors and adjust the position of the brushing tool in order to keep a fixed interference or pressure for the best working performance and for a lower filament wear. There are 4 most common ways to adjust the brush tool wear on these machines.

- Automatic indexing: Program an adjustment (indexing the tool on the Z axis) after a predetermined number of produced parts
- Probing: Numerical Control centers sometimes have the capability to probe the face of the brush in order to adjust the right interference of the filament tips with the workpiece
- Amperage metering: A fixed pressure can be controlled by monitoring the amp reading of the drive motor
- Manual indexing: where other methods can't be used the operator can adjust manually the interference based on visual inspection or on statistical process control of the processed parts



[www.sitbrush.tv/cnc](http://www.sitbrush.tv/cnc)

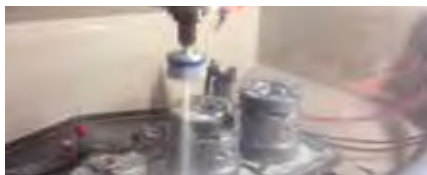
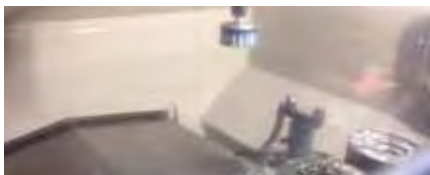

## I VANTAGGI DELLA SBAVATURA NEI CENTRI DI LAVORO / DEBURRING ON CNC MACHINE ADVANTAGES

### Miglioramento di processo:

- Eliminazione di sbavatura manuale e di ulteriori interventi sui pezzi fuori dal ciclo automatico
- Semplificazione del ciclo di lavoro (tempi e costi)
- Minori tempi e costi di trasporto e logistica

### Miglioramento di qualità:

- Precisione estrema nella sbavatura di ogni pezzo
- Omogeneità nella sbavatura dei pezzi
- Perfetta riproducibilità e standardizzazione dell'operazione

### Improved process:

- No hand deburring and other operations outside the automatic processing phase
- Simplified production cycle (time and cost)
- Less time and cost for logistics and product handling

### Improved quality:

- Extreme precision in deburring every piece
- Homogeneous deburring on each piece
- Standardization and repeatability of the process

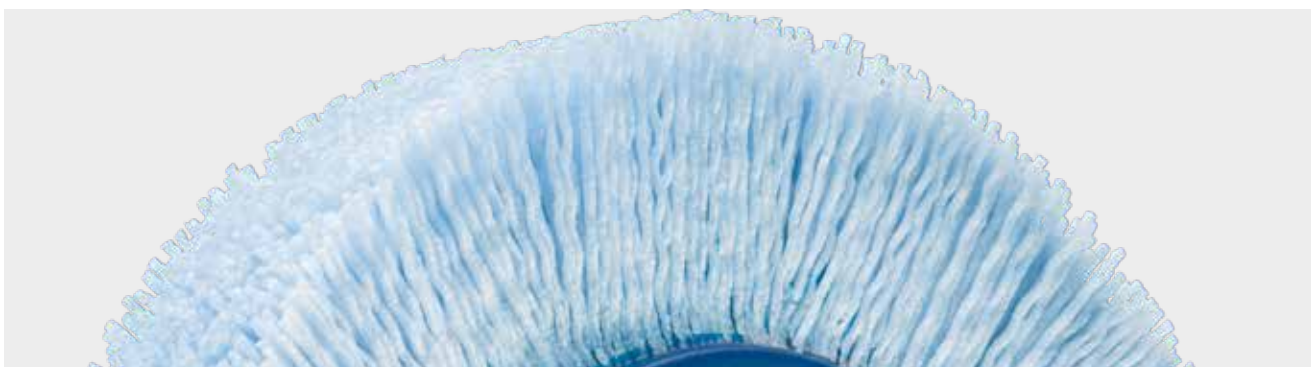

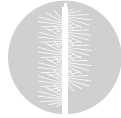

## SOLUZIONI TECNICHE / TECHNICAL SOLUTIONS

### > MODALITÀ COSTRUTTIVE / MANUFACTURING TYPES

# > Spazzole punzonate / Staple set brushes

Spazzole tecniche costituite da ciuffi di filamenti inseriti su un supporto solitamente in plastica (PVC, Nylon, ecc.) oppure in legno, alluminio o ottone. La grande flessibilità costruttiva e il peso contenuto rendono queste spazzole ideali per tantissime applicazioni industriali (anche in acqua, solventi o acidi).

Technical brushes made of tufts of filaments inserted on a plastic (PVC, Nylon, etc.), wooden, aluminium or brass support. Thanks to their low weight and great manufacturing flexibility, these brushes are ideal for many industrial applications (even in presence of water, solvents and acids).



### Disposizione dei Ciuffetti (PT, PL) / Tufts arrangement (PT, PL)

Nelle spazzole punzonate i ciuffetti vengono trattenuti nel supporto tramite ancorette metalliche che si fissano sul fondo dei fori fatti in precedenza. I ciuffetti possono essere disposti principalmente in 3 modi conferendo alla spazzola caratteristiche diverse.

Each tuft of these brushes is firmly fixed with a staple inside previously drilled holes in the support. Tufts can be arranged in 3 main ways giving the brush different features.

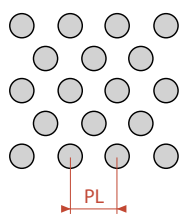

**Disposizione Sfalsata:** Spazzola particolarmente densa ed uniforme  
**Staggered pattern:** Uniform and high density brush

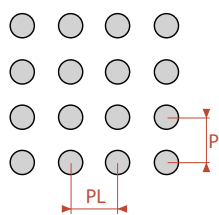

**Disposizione Parallela:** Spazzola poco densa, scarico delle scorie agevolato  
**Parallel pattern:** Low density brush, easy discharge of residues

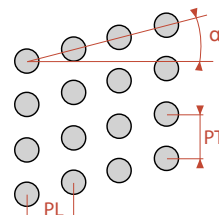

**Disposizione Elicoidale:** Spazzola adatta ad indirizzare da un lato le scorie  
**Helical pattern:** Brush apt to move slags and residues aside

### Dimensione dei Ciuffetti / Tufts size

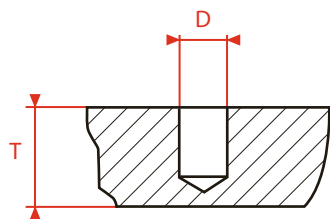

La dimensione D dei ciuffetti di filamento può variare, esiste inoltre una relazione tra diametro dei mazzetti e spessore T del supporto

**D** = da 2mm - 0.08" a 12mm - 0.47"

**T** = da 6mm - 0.23" a 24mm - 0.94"

Diametri diversi conferiscono alla spazzola caratteristiche diverse:  
**Ciuffi grandi** = spazzole adatte a lavori gravosi e con filamenti grossi

**Ciuffi piccoli** = spazzole adatte a lavori leggeri con foltezza elevata e filamenti di diametro sottile

Tufts diameter D can vary and it's strongly related to the support's thickness T.

**D** = from 2mm - 0.08" to 12mm - 0.47"

**T** = from 6mm - 0.23" to 24mm - 0.94"

Different diameters give the brush different characteristics:

**Big tufts** = brushes with thick filaments, suitable for heavy-duty jobs

**Small tufts** = High density brushes with thin filaments, suitable for light-duty jobs.



## > Spazzole punzonate / Staple set brushes

### Tipologie di spazzole punzonate / Types of staple set brushes

Esistono 3 tipologie principali di spazzole punzonate che si differenziano per come vengono impiegate nella spazzolatura (movimento relativo o assoluto rispetto all'oggetto da spazzolare e superficie di contatto con l'oggetto). Le 3 tipologie sono disponibili con qualsiasi materiale di supporto (plastica, legno, alluminio, ...) ed eventualmente con i ciuffi inclinati.

There are 3 main kind of staple set brushes for the way they are used (brush rotation and path and point of contact with the treated surface).

The 3 kinds are available in any support material (plastic, wood, aluminium, ...) and eventually with tufts' inclination.



#### Spazzole punzonate cilindriche / Staple set roller brushes

$D_1$  = Diametro esterno / Outer diameter  
 $D_2$  = Diametro nucleo / Shaft diameter  
 $D_3$  = Diametro foro / Hole diameter  
 $D$  = Diametro ciuffetto / Tuft diameter  
 $L$  = Lunghezza totale / Total length  
 $A, B$  = Distanza tra 1° foro e bordi nucleo / Distance between 1<sup>st</sup> hole and support ends  
 $L - A - B$  = Lunghezza utile spazzolante / Useful length  
 $PT, PL, \alpha$  = Disposizione dei ciuffi (sfalsata, parallela, elicoidale) / Tufts pattern (staggered, parallel, helical)

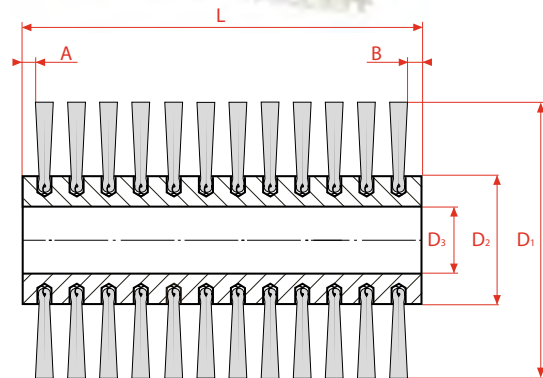

#### Spazzole punzonate piane / Plane staple set brushes

$W$  = Larghezza supporto / Support width  
 $L$  = Lunghezza supporto / Support length  
 $T$  = Spessore supporto / Support thickness  
 $H$  = Sporgenza filamento / Trim length  
 $D$  = Diametro ciuffetto / Tuft diameter  
 $A, B, C, E$  = Distanza tra 1° foro e bordi supporto / Distance between 1<sup>st</sup> hole and support's ends  
 $L - A - B$  = Lunghezza utile / Useful length  
 $W - C - E$  = Larghezza utile / Useful width  
 $PT, PL, \alpha$  = Disposizione dei ciuffi (sfalsata, parallela, elicoidale) / Tufts pattern (staggered, parallel, helical)

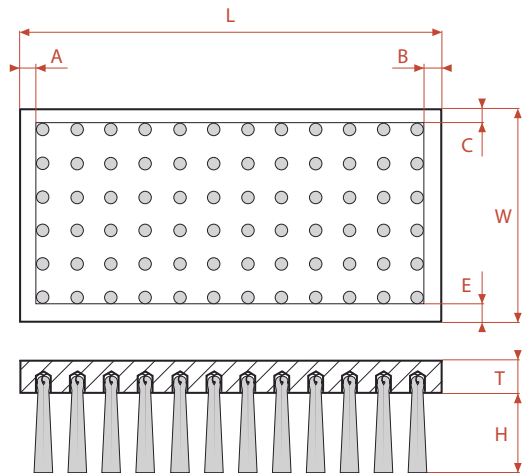

#### Spazzole punzonate a disco / Staple set disc brushes

$D_1$  = Diametro supporto / Support diameter  
 $D_2$  = Diametro esterno ciuffi / Tufts outer diameter  
 $D_3$  = Diametro interno ciuffi / Tufts internal diameter  
 $D_4$  = Diametro foro supporto / Support hole diameter  
 $D$  = Diametro ciuffetto / Tuft diameter  
 $T$  = Spessore supporto / Support width  
 $H$  = Sporgenza filamento / Trim length  
 $N^\circ$  ranghi/circonferenze di punzonatura / Number of Staple set rows  
 $PR, \alpha$  = Passo Radiale, disposizione dei ciuffi (sfalsata, parallela, elicoidale) / Tufts pattern (staggered, parallel, helical)

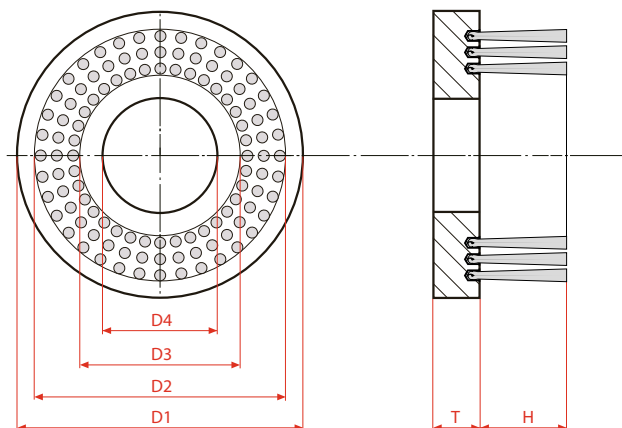



**> APPLICAZIONI INDUSTRIALI / INDUSTRIAL APPLICATIONS**

**> Trattamento leghe leggere e applicazioni del nylon abrasivo / Aluminium Alloys treatment and abrasive nylon applications**



Le **Spazzole SIT** utilizzano la più alta qualità di Nylon impregnata di grana abrasiva al carburo di silicio, ossido di alluminio, silicato di alluminio, anche con grana ceramica o diamantata. Le spazzole in nylon abrasivo sono **ingegnerizzate per applicazioni di sbavatura, pulitura, smussatura e finitura superficiale** di diversi materiali.

**SIT Brushes** are manufactured with Nylon of the best quality loaded with silicon carbide, aluminum oxide or aluminum silicate and even with ceramic or diamond abrasive grain. Abrasive nylon brushes are **designed for deburring, cleaning, radiusing and finishing operations** on different materials.



**CS - Silicon Carbide**



**Multi-Filament**



**CR - Ceramic**



**DI - Diamond**

**Il filamento Nylon Abrasivo / Abrasive Nylon filaments**

**Caratteristiche / Features**

Il filamento è composto da una matrice di Nylon 612 con grani abrasivi ed è ideale come materiale per le spazzole grazie a:

- Capacità di abrasione
- Resistenza chimica
- Flessibilità dei filamenti, che rende possibile lavorazioni anche su superfici non piane
- Lunga durata

The filament is made of a Nylon 612 base with abrasive grains and it's ideal for brushing operations thanks to:

- Abrasion capacity
- Chemical resistance
- Filaments flexibility, which allows to process uneven surfaces
- Long lasting

**Grane Disponibili / Available grits**

**CS** Grano abrasivo in **Carburo di Silicio**:  
 • Filamento a sezione tonda: da grana 36 a grana 500  
 • Filamento a sezione rettangolare: grana 80/120/180/320

**Abrasive grit in Silicon Carbide**:  
 • Round section filament: from grit 36 to grit 500  
 • Rectangular section filament: grit 80/120/180/320

**OA** Grano abrasivo in **Ossido di Alluminio**:  
 • Filamento a sezione tonda: da grana 80 a grana 600

**Abrasive grit in Aluminium Oxide**:  
 • Round section filament: from grit 80 to grit 600

**SA** Grano abrasivo in **Silicato di Alluminio**:  
 • Filamento a sezione tonda: grana 2000

**Abrasive grit in Aluminium Silicate**:  
 • Round section filament: grit 2000

**CR** Grano abrasivo **Ceramico**:  
 • Filamento a sezione ovale: grana 46  
 • Filamento a sezione rettangolare: grana 80  
 • Filamento a sezione tonda: da grana 80 a grana 320

**Abrasive grit in Ceramic**:  
 • Oval section filament: grit 46  
 • Rectangular section: grit 80  
 • Round section: from grit 80 to grit 320

**DI** Grano abrasivo **Diamantato**:  
 • Filamento a sezione tonda: da grana 120 a grana 1800

**Abrasive grit in Diamond**:  
 • Round section: from grit 120 to grit 1800

A richiesta sono disponibili grane diverse da quelle indicate / Different grits are available upon request.  
 Per le dimensioni della grana in micron o pollici vedi tabella a pag. 163 / For grit size conversion to micron or inches see table on page 163.

### Abrasivi Resistenti ad Alte Temperature HT150-HT250 / High temperature resistant Abrasive Filaments HT150-HT250

SIT ha introdotto per la propria gamma di spazzole i nuovi filamenti abrasivi ondulati HT150 e HT250 resistenti alle alte temperature. HT150 e HT250 sono in grado di **lavorare in modo continuativo rispettivamente alle temperatura di 150°C - 302 °F e 250 °C - 482 °F** e possono essere caricate con inerti abrasivi di varia specie e dimensione di grana.

Grazie alla sua resistenza agli effetti della temperatura, il filo può lavorare a velocità lineari di 60 m/s, superiori a quelle sopportabili da ogni altro filo abrasivo tradizionale, basato su matrice sintetica di PA 6.12. Le spazzole realizzate con filo HT150 e HT250 possono così sviluppare un **"lavoro" di abrasione 5 volte superiore** a quelle tradizionali.

Grazie alle loro caratteristiche, le spazzole HT150 e HT250 possono addirittura sostituire spazzole realizzate con filo ondulato d'acciaio inossidabile in alcune applicazioni, risultando inoltre 2 volte superiori per potere abrasivo.

Infine, il costo del filo HT150 e HT250 risulta relativamente contenuto ed è confrontabile con quello del filo d'acciaio inossidabile, tenuto conto del rapporto di peso specifico e della differenza di prestazione.

SIT has introduced in its wide inventory a new kind of abrasive filament, the high temperature resistant HT150 and HT250.

HT150 and HT250 are able to **work continuously at 150°C - 302°F and 250°C - 482°F temperature** respectively, and can be loaded with abrasive aggregates of different kind and grain.

Thanks to its heat resistance, the filament can be used with sliding speed of 60 m/s, higher than traditional (based on PA 6.12 synthetic matrix) abrasive filaments working speed. HT150 and HT250 brushes can therefore generate **an abrasive effect 5 times higher** than the traditional ones.

Thanks to these characteristics, they can replace stainless steel wire brushes in applications concerning the brushing of surface of stainless steel, and grant a 2 times higher abrasive power.

The HT150 and HT250 filament cost is relatively low; considering the difference in specific weight and performance it can be compared with the stainless steel wire's cost.

### La scelta del tipo di abrasivo / How to choose the right abrasive filament

Il consiglio di SIT è quello di utilizzare Carburo di Silicio per tutte le applicazioni che richiedono una forte asportazione di materiale. Consigliamo invece di usare Ossido di Alluminio o Silicato di Alluminio dove il Carburo di Silicio è troppo aggressivo o comporta contaminazione in alcune applicazioni su materiali non ferrosi (materiali teneri, materie plastiche, alluminio).

Filamento Ceramico è utilizzato come alternativa al Carburo di Silicio per raggiungere velocità di taglio e performance superiori nel trattamento di metalli duri.

Il filamento Diamantato infine è consigliato per la sbavatura e finitura di precisione di leghe durissime (titanio, carburo di tungsteno, ...).

**L'efficacia della spazzolatura varia in funzione di velocità, pressione, densità, sporgenza del filo e soprattutto in funzione del tipo di filamento.**

Le grane 120 e 180 possono essere utilizzate nella maggior parte delle applicazioni e comunque come punto di partenza del trattamento superficiale, dopodiché, a seconda del grado di finitura richiesto, si può optare per una grana più opportuna.

SIT recommends the use of Silicon Carbide abrasive filament for applications requiring a strong material removal.

Aluminium Oxide/Aluminium Silicate are suitable when the Silicon Carbide is too aggressive or may cause contamination in some applications on non-ferrous materials (soft materials, plastic materials, aluminum).

Ceramic filament is used as an alternative to Silicon Carbide for higher working speed and increased performance on hard metal working.

Diamond filament is recommended for precision deburring and finishing of very hard alloys (titanium, tungsten carbide, ...).

**The brushing effectiveness depends on speed, pressure, density, trim length and filling material.**

Grits 120 and 180 can be used in most applications and anyway as the first test step for the surface treatment, after which, depending on the level of required finishing, a different and more appropriate grit can be adopted.

	ALLUMINIO MAGNESIO ALUMINIUM MAGNESIUM	<25 HRC	<45 HRC	<55 HRC	<60 HRC	<67 HRC	ACCIAIO INOX STAINLESS STEEL	TITANIO TITANIUM	GHISA GRIGIA GG(G) DUCTILE CAST IRON GG(G)	Filamenti abrasivi consigliati in base alla durezza del materiale da lavorare / Recommended abrasive filaments for different materials based on hardness
CS - Silicon Carbide	✓	✓	⬆	⬆	⬆	✗	✓	✗	⬆	✓ Best fit
CR - Ceramic	⬆	⬆	✓	✓	✓	✗	✓	✓	✓	⬆ Admissible solution
DI - Diamond	✗	✗	⬆	✓	✓	✓	⬆	✓	⬆	✗ Non recommended



Spazzola a disco per la finitura di stampati in ghisa / Disc brush for cast iron finishing



Scovolo per sbavare fori filettati / Twisted in brush for threaded holes deburring



Scovolo ceramico per sbavare fori / Ceramic twisted in brush for holes deburring





# SOLUZIONI TECNICHE / TECHNICAL SOLUTIONS

## > Trattamento leghe leggere / Aluminium Alloys treatment

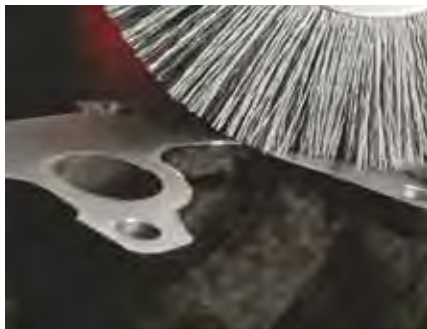
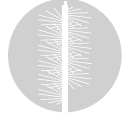

Circolare per pulire uno stampato in ghisa / *Wheel brush for cast iron cleaning*



Spazzola in Carburo di Silicio per sbavare ruote dentate / *Silicon carbide brush for gear splines deburring*



Spazzola in filamento ceramico per sbavare ruote dentate / *Ceramic brush for gear splines deburring*



Sbavare oggetti estrusi in alluminio / *Deburring of extruded aluminium profiles*



Rifinire ingranaggi in leghe leggere / *Light alloys finishing*



Spazzola a disco per rifinire cerchi in lega / *Disc brush for wheel rims finishing*



Spazzola a rullo per il trattamento superficiale del legno / *Roller brush Wooden surface treatment*



Rifinire albero a camme in acciaio / *Steel camshaft finishing*

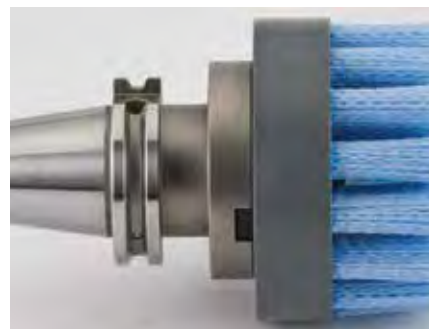

Spazzola a disco su mandrino porta fresa per centri di lavoro automatici / *Disc brush with shell-mill holder for automatic machining centers and CNC*

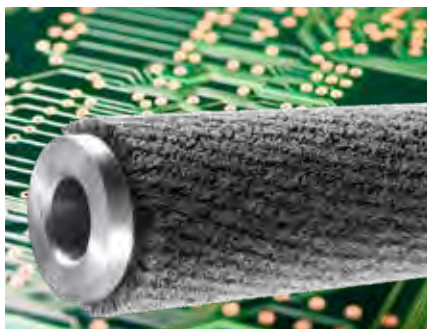

Pulizia circuiti stampati / *Printed circuit board cleaning*

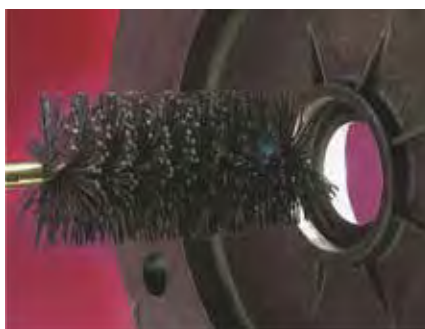

Sbavare fori su ghisa / *Cast iron holes deburring*

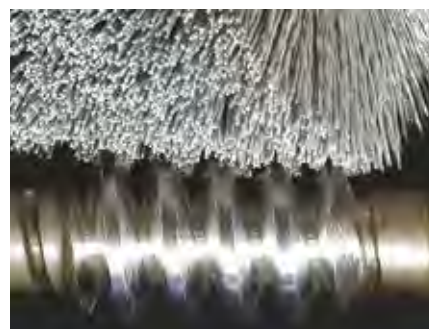

Pulire profili dentati / *Crown profiles cleaning*

### Consigli di spazzolatura con le spazzole in Nylon Abrasivo / Recommendations for working with abrasive nylon brushes

Mentre le spazzole in filamento metallico asportano materiale "per impatto", le spazzole con filamento in Nylon abrasivo agiscono "per abrasione" per cui, in generale, sono da preferirsi in caso di velocità e pressioni di lavoro più basse.

*Metallic wire brushes remove the material "by impact" while brushes with abrasive nylon filament act "through abrasion" so, generally we recommend the use with lower working speed and pressure.*

#### Pressione / Pressure

Nel caso di spazzole circolari in Nylon abrasivo si ottengono la massima efficacia di spazzolatura e una lunga durata della spazzola con interferenze di lavoro inferiori a 1/8 della sporgenza. Nel caso di spazzole a disco usare profondità di interferenza da 1.3mm - 0.05" a 2.5mm - 0.10". Si consiglia comunque di iniziare il lavoro alla minima interferenza/pressione possibile, aumentando la pressione fino ad ottenere il risultato desiderato.

*For abrasive nylon wheel brushes the highest brushing effectiveness and a long service life of the brush can be obtained with work interferences less than 1/8 of the trim length. In case of disc brushes use penetration from 1.3mm - 0.05" to 2.5mm - 0.10". We recommend to start working with the minimum penetration/pressure possible, increasing it until the desired result is obtained.*

#### Velocità di Rotazione / Rotation Speed

La velocità ottimale dipende dal tipo di applicazione e dal tipo di spazzola adottato. In generale, per spazzole circolari si raccomandano velocità periferiche non superiori a 18-20 m/s - 3540-3940 ft/min. Per spazzole frontali/a disco usare velocità più basse. Vedi anche tabella pag. 169.

*Optimum speed depends on the type of application and the type of brush used. In general for wheel brushes we recommend peripheral speed not higher than 18-20m/s - 3540-3940 ft/min. For discs/front brushes we recommend lower speed. See also table at page 169.*

#### Refrigerazione / Refrigeration

Per applicazioni gravose si raccomanda l'uso di refrigeranti (acqua filtrata), per evitare la riduzione delle caratteristiche di resistenza meccanica del filamento e per ottenere finiture più brillanti. Il fluido refrigerante è sempre consigliato in caso di applicazioni ad alte velocità di rotazione, per elevate penetrazioni o per lavorazione su spessori sottili.

*We recommend the use of coolants (filtered water) for heavy-duty applications in order to avoid the reduction of the filament's mechanical resistance and to obtain a more glossy finishing. Coolant is always recommended for applications requiring high speeds, high penetration and are used on very thin parts.*

#### Avanzamento / Feed Rate

Diminuendo l'avanzamento si ottengono massima raggiatura degli spigoli e completa rimozione delle bave. Su materiali teneri è possibile avere velocità di avanzamento superiori. Vedi anche tabella pag. 169.

*Decreasing the feed rate you can obtain: maximum edge radiusing, complete burrs removal. On soft materials you can have higher feed rates. See also table at page 169.*

### Esempi ed effetti della spazzolatura con Nylon Abrasivo / Example and effects of brushing with Abrasive Nylon

Esempi di utilizzo del nylon abrasivo su diversi materiali. Gli esempi sono indicativi e sono stati ottenuti a seconda del materiale da trattare con spazzole di varia forma, grana e diametro del filamento. Il nostro ufficio tecnico saprà consigliarvi al meglio sul tipo di spazzola da utilizzare.

*Examples of use of the abrasive nylon on different materials. The examples are indicative and have been obtained depending on the material to be treated with brushes of different shapes, grits and filament sections. Our technical office will advise on the best type of brush to be used.*



Acciaio / Steel



Ferro / Iron

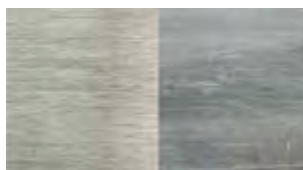

Alluminio / Aluminium

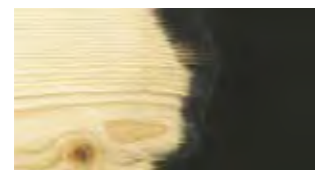

Vernice su legno / Paint in wood



Mattone / Brick



Travertino / Travertine

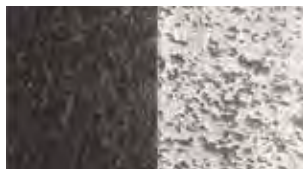

Ardesia / Slate



Inox / Stainless steel



Legno / Wood



Saldatura su alluminio / Welding on aluminium



Saldatura su ferro / Welding on iron





## SOLUZIONI TECNICHE / TECHNICAL SOLUTIONS

### > Trattamento leghe leggere / Aluminium Alloys treatment

#### Applicazioni di trattamento e finitura delle superfici in alluminio / Aluminium surface treatment and finishing applications



SIT ha una famiglia di prodotti dedicata agli specialisti delle leghe leggere. Questi prodotti coprono l'intero processo produttivo, sin dalle prime fasi di realizzazione dei semilavorati in cui si possono utilizzare:

1. Spazzole per utensile elettrico o ad aria per la **pulizia degli stampi**
2. Grandi spazzole a rullo per la **pulizia dei cilindri di laminazione**
3. Spazzole a disco o a tazza per **rimuovere le bave** dopo le lavorazioni meccaniche o di stampaggio
4. Spazzole circolari con filamenti in acciaio inossidabile per la **satinatura dei profili estrusi**

SIT has a specific product line for aluminium alloys treatment. This products cover the entire manufacturing process from the first cycles of manufacturing of work-in-progress goods:

1. **Mould cleaning** brushes for power tools
2. Roller brushes for **cleaning of rolling cylinders**
3. Disc or cup brushes for **deburring after moulding** or machining
4. Wheel brushes with filaments for **satin finishing of extruded sections**



#### Soluzioni per la satinatura / Satin finishing solutions

Al fine di esaltare le caratteristiche estetiche dell'Alluminio, gli estrusi, le lamiere ed i profilati necessitano di delicate operazioni di satinatura prima dell'ossidazione anodica o dell'elettrocromazione.

SIT propone una serie completa di spazzole specifiche per la satinatura compatibili con le più diffuse macchine satinatrici: Anelli con Diametro 300 mm - 11-3/4" e Foro 80mm - 3-1/8", Diametro 250mm - 9-7/8" e Foro 40mm - 1-5/8" , in Acciaio Inox da 0,15mm - 0.006" fino a 0,60mm - 0.024", Rulli in Nylon abrasivo di varie sezioni, tipi e grane, permettono di ottenere un ampio ventaglio di finiture superficiali.

extruded products, plates and profiles need delicate satin finishing operations before anodising or electrocoloring.

SIT offers a complete range of specific brushes for satin finishing compatible with the most widespread satin finishing machines:

Single section brushes with 300mm - 11-3/4" diameter and 80mm - 3-1/8" hole, diameter 250 mm and 40 mm hole, in Stainless Steel from 0,15mm - 0.006" up to 0,60mm - 0.024", Roller brushes in abrasive Nylon of different sections, types and grits, allow to obtain a wide range of surface finishing.

In order to exalt the aesthetic characteristics of Aluminium,



#### Sbavatura alluminio con macchinari / Deburring aluminium with machines

**Tempi di lavorazione ridotti e miglioramenti qualitativi** sono risultati attesi introducendo le **operazioni di sbavatura e finitura** all'interno di centri di lavoro a controllo numerico CNC.

Il pezzo da lavorare ed il tipo di operazione richiesta suggeriranno la spazzola ideale.

Spazzole circolari, a tazza, a disco, scovoli di varie dimensioni, differenti tipi e grane di nylon abrasivo (o fili metallici), sezione e diametro del filo, sporgenza, intersezione di lavoro, velocità di rotazione e di avanzamento sono le variabili su cui l'assistenza tecnica SIT vi saprà indirizzare per ottimizzare il risultato.

**Reduced processing time and quality improvements** can be obtained with automatic machines and robotic cells carrying out **deburring and finishing operations**.

The piece to deburr and the kind of operation required will drive to the ideal brush.

Wheel, cup and disc brushes, tube brushes of different size, different kinds and grits of abrasive nylon (or metallic wires), filament section and diameter, trim length, working interference, rotating and advancement speed, those are the variables on which SIT technical assistance can give you any advice in order to optimize the final result.



#### Spazzole per la pulizia di Stampi e Fori / Brushes for cleaning Moulds and Holes

La pulizia degli stampi è un'operazione importante e delicata a causa delle forme complicate che questi possono assumere. SIT propone una serie completa di scovoli, pennelli e spazzole a mano per raggiungere anche gli angoli più nascosti degli stampi.

Mould cleaning is an important and delicate operation because of the complex shapes that moulds can have.

SIT offers a complete range of twisted in brushes, end brushes and hand brushes for reaching the most difficult mould's corners and edges.

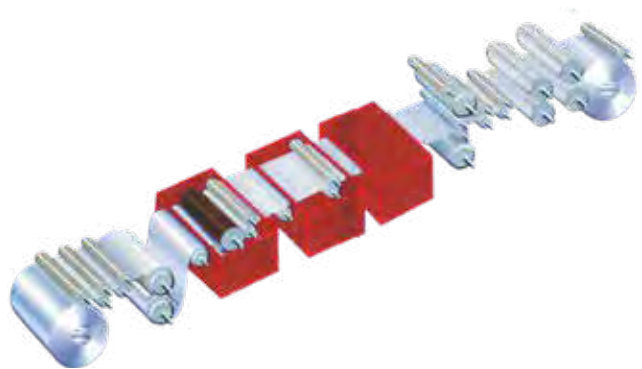

#### Pulizia dei Cilindri di Laminazione / Brushes for cleaning of Rolling Cylinders

Ogni cilindro di laminazione deve essere pulito attentamente, per evitare che i piccoli residui che rimangono aderenti a queste delicate superfici, provochino impronte e difetti nei laminati.

Per evitare che ciò accada SIT ha realizzato delle spazzole a rullo estremamente compatte che, grazie al particolare filamento ed alla superficie rettificata, garantiscono la pulizia e funzionalità dei cilindri di laminazione.

Each rolling cylinder must be perfectly cleaned to avoid the presence of scraps that can cause finishing defects on these delicate surfaces.

To avoid this SIT has designed special brushes with very high filling density that, thanks to a specific filament and the rectified surface, ensure the cleaning and the functionality of the lamination cylinders.



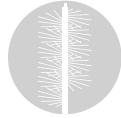

## SOLUZIONI TECNICHE / TECHNICAL SOLUTIONS

### > APPLICAZIONI INDUSTRIALI / INDUSTRIAL APPLICATIONS

# > Spazzole per laminazione / Brushes for rolling mills

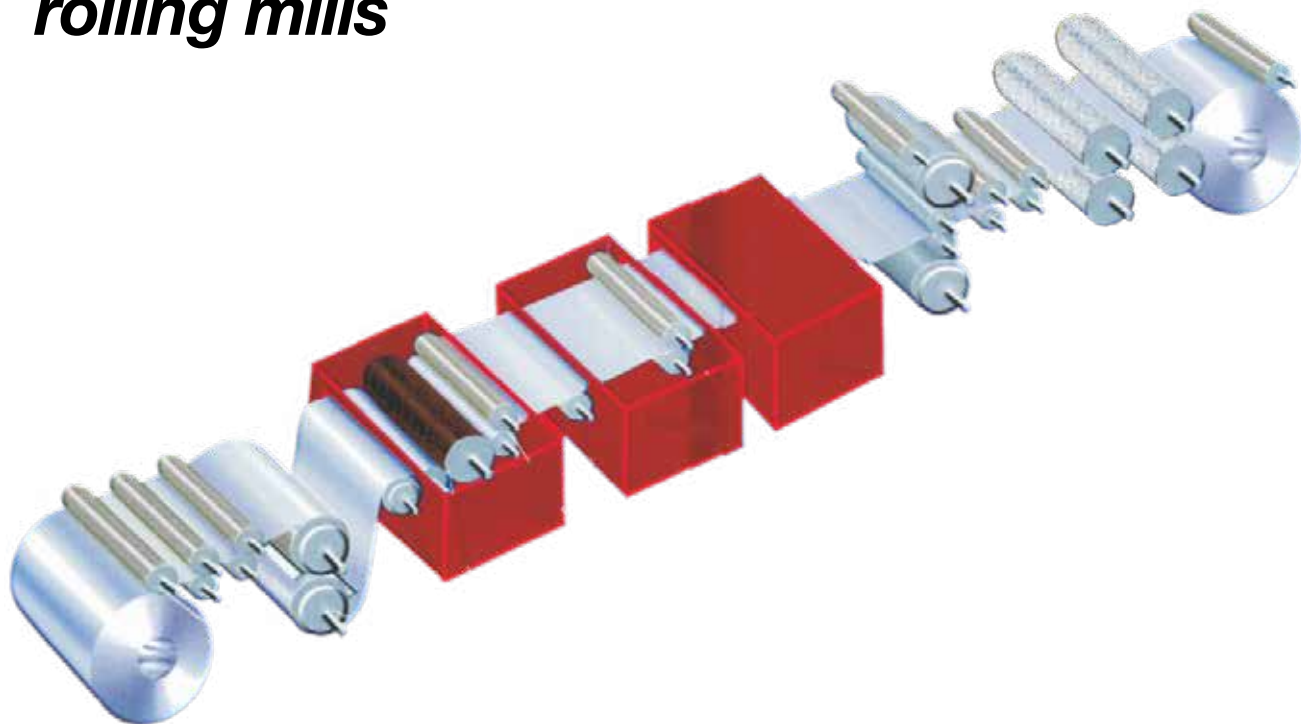

Negli impianti di laminazione e nel trattamento di coils in acciaio, acciaio inox, alluminio, rame e leghe possono essere necessari il decapaggio o il trattamento superficiale in generale.

Per esempio le superfici dei coils laminati a freddo devono essere pulite prima di essere processate all'interno della linea di finitura di un laminatoio. Questo processo è veramente importante per garantire una ricottura precisa ed una rifinitura costante del coil metallico.

Per questo sono indispensabili gruppi spazzolanti che montino spazzole cilindriche specialmente realizzate e adatte allo scopo.

*In rolling mills and in steel, stainless steel, aluminium and alloy coils treatment can be necessary either a pickling or a surface treatment.*

*For example Cold Rolled Coil surfaces must be cleaned before being processed in the finishing line in the primary metal industry. This cleaning process is very important in order to guarantee a consistent annealing and metallic coating process of the metallic coils.*

*This is why brushing machines with custom technical brushes are necessary. Our Technical Office is available to identify, according to customers' requirements, the right brush.*

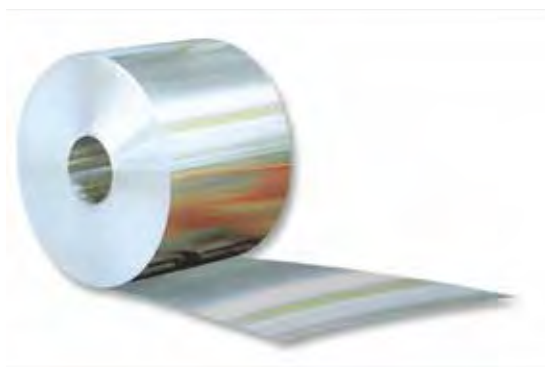

## > Laminazione / Rolling mills

### Metodologie costruttive / Manufacturing types

Le spazzole cilindriche per laminazione e decapaggio possono essere montate su nuclei a tubo cavo o su albero pieno con mozzi. I nuclei possono essere riutilizzabili o meno.

Le spazzole per il decapaggio ed in generale le spazzole ad anelli o a spirale di grandi dimensioni vengono montate su nucleo con mozzi e ghiera di bloccaggio che consentono una rapida sostituzione della spazzola. Ogni elemento viene disegnato e costruito secondo le esigenze di montaggio e di lavorazione del cliente. SIT Tecnospazzole offre ai propri clienti un servizio di ritorno delle spazzole consumate per smontarle, ricondizionare il nucleo e ricostruire la spazzola. Questo comporta un risparmio economico ed un minor impatto ambientale.

*Wide face brushes for rolling mills and pickling can be mounted on a tube or on a shaft with hubs. Cores can be single-use or reusable.*

*Brushes for pickling and generally single section wheels and spiral brushes are mounted on the core with hubs and locking flanges that allow a fast replacement of the brush. Every item is designed and built in accordance to customer's needs (mounting and processing). SIT Tecnospazzole offers to its customers the service of returning the brush worn out to re-use the core. This way the customer has an economical saving and a lower environmental impact.*



### Materiali, tipologie di superfici e filamenti / Materials, types of surface and filaments

La superficie trattata può essere di tipo ferroso (acciai al carbonio e inossidabili) o non ferroso (alluminio, rame e leghe speciali). A seconda del tipo di finitura richiesto, può essere utilizzato del filamento a sezione rettangolare, ellittica o circolare.

Nell'industria della laminazione vincoli di velocità e di meccanica delle linee esistenti fanno sì che il filamento dei rulli spazzolanti sia l'unica variabile sulla quale lavorare per migliorare la performance di pulizia. I clienti di SIT possono scegliere all'interno di un'ampia offerta di filamenti sintetici (mono filamento e anche multi filamenti) o metallici (vedi pagg. 13 e 18).

*Treated surface can be ferrous (carbon steel and stainless steel) or non-ferrous (aluminium and special alloys). Depending on the type of required finishing, filament with rectangular or oval or circular section can be used.*

*In primary metal industry speed issues and mechanical limitations of existing lines make the filament of the roller brushes the only variable to work on in order to increase cleaning performance. SIT's customers can choose among a wide range of synthetic filaments (monofilament and even multi filament) or metallic wires (see pages 13 and 18).*

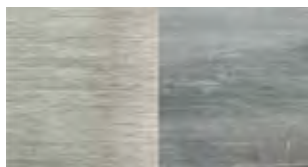
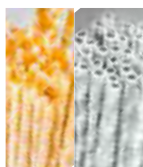

Alluminio / Aluminium



Acciaio / Steel



Inox / Stainless steel

### Filamenti utilizzati per spazzole da laminazione / Type of filaments for rolling mills brushes

Applicazione / Application	Filamento / Filament
Lavaggio / Washing	Nylon 6.6/PPL / Nylon 6.6/PPL
Lucidatura / Polishing	Nylon Abrasivo Grana 2000-600 Ossido di Alluminio Abrasive Nylon Grit 2000-600 Aluminium Oxide
Finitura / Finishing	Nylon Abrasivo Grana 500-240 Ossido di Alluminio Abrasive Nylon Grit 500-240 Aluminium Oxide
Asportazione / Removal	Nylon Abrasivo Grana 180-80 Carburo di Silicio Abrasive Nylon Grit 180-80 Silicon Carbide
Forte Asportazione (Rottura scaglia superficiale) Strong Removal (Breaking the surface chippings)	Nylon Abrasivo Grana 60-36 Carburo di Silicio Abrasive Nylon Grit 60-36 Silicon Carbide
Maggiore capacità di pulizia e maggiore durata / Increased cleaning performance and longer brushing life	Multi-Filament
Maggiore resistenza alla fatica / Breakage reduction	Multi-Filament





## > Laminazione / Rolling mills

### Fattori caratteristici che contraddistinguono le spazzole SIT / Distinguishing characteristics of SIT brushes

- Perfetta cilindricità
- Perfetta rasatura della superficie
- Altissima densità dei filamenti
- Altissima qualità dei materiali di supporto e dei filamenti utilizzati
- Accurata bilanciatura dinamica con certificato di accompagnamento
- Ottimizzazione dei costi per il cliente con il recupero dei nuclei delle spazzole

- Perfect cylindricity
- Perfect surface trimming
- Very high fill density
- Very high quality of support materials and filaments
- Precise dynamic balancing followed by a certificate
- Cost optimization for customers thanks to regeneration of brush shafts

#### Dimensioni massime e minime realizzabili

SIT realizza un ampio range di spazzole diverse per dimensioni e tipologia. Inoltre, per soddisfare le esigenze del cliente, i fori e le riduzioni dei nuclei delle spazzole sono realizzati a disegno sulle specifiche dell'impianto su cui vengono montate.

#### Minimum and maximum size achievable

SIT can manufacture a wide range of brushes for dimensions and type. In order to satisfy customer needs, brushes' cores and adapters are manufactured on drawing according to specific requirements of the rolling mill plant on which they will be mounted.

### Dimensioni massime e minime realizzabili / Maximum and minimum dimensions

	MIN → MAX	
	mm	inch
<b>Diametro esterno / Outer diameter</b>	150 → 600	5-7/8 → 23-5/8
<b>Lunghezza / Length</b>	400 → 6000	15-3/4 → 236-1/4



Modulo intercambiabile in filamento abrasivo. Può essere realizzato in tutti i tipi di grane e sezioni. / Abrasive filament interchangeable brush. It can be manufactured with every grit size and filament section.



Modulo intercambiabile in nylon con riduzioni saldate. Utilizzato nelle stazioni di lavaggio degli impianti di laminazione. / Interchangeable nylon brush with welded adapters. It's used inside rolling mill's washing stations.



Spazzola in spugna e tela abrasiva per il decapaggio e la finitura superficiale dei coils. / Sponge and abrasive cloth brush for coil's pickling and surface finishing.

### Trattamento dei coils e delle lamiere nell'industria della laminazione / Roller brushes for primary metal industry applications

#### Settore/applicazione industriale

- Linea di pulizia e galvanizzazione (CGL, HDGL) → Pulizia, rimozione di impurità e di olii da laminazione mediante spazzolatura con acido o con acqua
- Linea di decapaggio a caldo (HPL) → Spazzolatura ad acqua pre e post decapaggio
- Linea di ricottura (CAL) → Pulizia, sgrassatura e lucidatura
- Linea di ricottura e decapaggio inox (CAPL) → Spazzolatura e lucidatura ad acqua post decapaggio acido
- Linea di elettro galvanizzazione (EGL)
- Linea di ricottura "brillante" (BAL)
- Linea di lavaggio pannelli e lamiere → Spazzolatura con olio dei grezzi pre stampaggio (automotive) e lavaggio acido di alluminio (aerospaziale)

#### Type of primary metal application

- Cleaning, Galvanizing Linea (CGL, HDGL) → Cleaning, removal of impurities and milling oil in alkali brushing and water brushing
- Hot Pickling Line (HPL) → Pre and post pickling water brushing
- Annealing Line (CAL) → Cleaning, degreasing, polishing
- Cold Stainless Annealing and Pickling Lines (CAPL) → Water brushing and polishing after acid pickling
- Electro galvanizing Line (EGL)
- Bright Annealing Line (BAL)
- Sheet/Panel washing machines → Blank washer oil brushing before stamping (automotive) and aluminum alkali brushing (aircraft)

## > Laminazione / Rolling mills

### Fasi del processo

- Unità di spazzolatura per pulizia e sgrassatura elettrolitica
- Unità di spazzolatura post rottura della bava
- Unità di spazzolatura post decapaggio
- Unità di spazzolatura post ricottura
- Unità di spazzolatura nelle linee di finitura (taglio, taglio a misura, tranciatura)
- Unità di lucidatura in laminazione a freddo

### Funzione

- Spazzolatura con soluzione acida
- Spazzolatura post lavaggio a caldo
- Spazzolatura post lavaggio a freddo
- Pulitura superficiale
- Lucidatura dei rulli
- Finitura superficiale
- Rimozione/decapaggio

### Equipment range

- *Brushing units in cleaning and electrolytic degreasing sections*
- *Brushing units after scale breaker units*
- *Brushing units after pickling tanks*
- *Brushing units in quench section*
- *Brushing units in finishing lines (slitter, cut-to-length, blanking...)*
- *Polishing rolls units in CRM*

### Brush function

- *Acid brushing*
- *Hot water brushing*
- *Cold water brushing*
- *Surface cleaning*
- *Roll polishing*
- *Surface finishing*
- *Descaling/pickling*



## Parametri operativi raccomandati / Recommended operating parameters

- Range di pH a cui è esposto il filamento (soluzione con la quale lavora): 3-14
- Velocità consigliata della spazzola a rullo: 750-900 RPM
- Velocità massima di servizio della spazzola a rullo: 1000 RPM
- Temperatura di servizio consigliata: 65 → 85 °C - 149 → 185 °F
- Interferenza del filamento: 1 → 5mm - 0.04" → 0.2"
- *Filament pH range service: 3-14*
- *Brush roll recommended speed: 750-900 RPM*
- *Brush roll max. service speed: 1000 RPM*
- *Brush roll range service temperature: 65 → 85 °C - 149 → 185 °F*
- *Brush roll bristles depth of penetration: 1 → 5mm - 0.04" → 0.2"*

## Rasatura ed equilibratura / Trimming and balancing

Le spazzole per laminazione subiscono una precisa rasatura (o anche rettifica nel caso di spazzole in acciaio) ed un'equilibratura dinamica secondo la norma ISO 1940 (vedi pag. 154).

*Rolling mills brushes have a special trimming (or even grinding in case of metallic wire) and a dynamic balancing according to ISO 1940 (see page 154).*



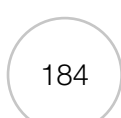
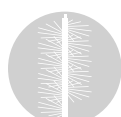

# > Unità Spazzolanti per nastri trasportatori / Brushing Units for conveyor belts



I nastri che trasportano qualsiasi tipo di materiale richiedono una manutenzione frequente perché, se non si provvede alla rimozione dei residui subito dopo il punto di scarico, questi si accumulano sulle pulegge e sui rulli di rinvio provocando logoramento e danni ai nastri stessi.

Le Unità Spazzolanti sono studiate e realizzate da SIT per ottenere una pulizia radicale dei nastri, onde evitare gli inconvenienti che si verificano con pulitori di tipo tradizionale.

Questi sistemi brevettati per la pulizia dei nastri hanno come organo operante una spazzola di forma cilindrica a settori, strip, elicoidali (vedi Rulli Master pag. 156) o eventualmente anche una spazzola a spirale.

*Conveyor belts, transporting every kind of material, require a frequent maintenance as slugs and residues, when not removed after unloading, will accumulate on the pulleys and on the guide rollers causing wear, tear and damages to the belts. Brushing Units are designed and manufactured by SIT to obtain a radical cleaning of the belts, to avoid clogging and inconvenience that takes place with other types of cleaner.*

*These patented systems for belts cleaning are made up with a special roller brush with helical segments, strips (see Master Rolls page 156) or eventually with a spiral brush..*

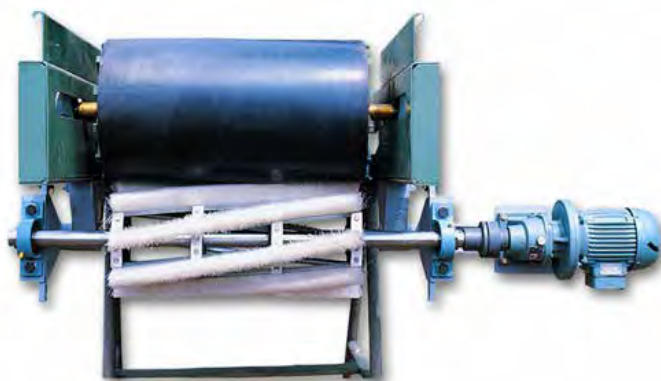

## > Nastri trasportatori / Conveyor belts

Le Unità Spazzolanti sono costituite da un telaio modulare sul quale sono montati la spazzola ed il motore. Il telaio è applicabile mediante bulloni alla struttura del nastro trasportatore. I motori normalmente montati sono asincroni trifasi, tensione 220/380 V, 50 Hz, costruzione chiusa, ventilazione esterna e rotore a gabbia. Protezione IP44. Forme costruttive diverse per tipo UST e tipo USLT.

La spazzola è azionata da un motore elettrico a mezzo di cinghia (USLT) o di riduttore coassiale ad ingranaggi elicoidali con giunto elastico (UST).

La regolazione della pressione della spazzola contro il nastro si ottiene agendo su due tiranti laterali. La spazzola è costituita da un albero di acciaio portante dischi in ghisa torniti sui quali vengono applicati gli strip mediante tasselli in alluminio avvitati agli stessi.

*Brushing Unit are made of a modular frame on which brush and engine are mounted. The frame can be easily fixed to the conveyor belt's structure with tightening bolts.*

*Engines usually mounted are asynchronous three-phased, 220/380 V tension, 50Hz, closed construction, external ventilation and rotor. Protection IP44. Different construction forms for UST type and for USLT type. The brush is actuated by the electrical engine along with a driving belt (USLT) or a geared-engine (with helical coaxial gears) with elastic joints (UST).*

*The brushing pressure can be adjusted by the pulling rods on the sides. The body of the brush consists of a steel shaft carrying turned cast iron (or steel) disks, on which the Strip brushes are mounted using aluminium dowels screwed on them.*

## Tipologie di Unità Spazzolante / Brushing Units types

Le Unità Spazzolanti di produzione standard si distinguono per come viene calettato il motore all'albero, e per come vengono fissate le spazzole alla struttura. In particolare sono di due tipi.

*Standard Brushing Units differ for the way the engine is keyed on the motor shaft, and for the way the brushes are fixed to the frame. There are two main types.*

**UST Unità Spazzolante Normale**, con motoriduttore calettato all'asse di rotazione della spazzola. Sono indicate per la pulizia di nastri trasportatori di grandi dimensioni, per condizioni di lavoro gravose e per trasporto di materiali umidi e pastosi. Diametro esterno standard Ø 300mm - 11-3/4". A richiesta Ø 270mm - 10-5/8" → 350mm - 13-3/4".

**UST Standard Brushing Unit**, with driving gear motor keyed on the rotation axis of the brush. They are recommended for large conveyor belts' cleaning, for harder working conditions and for the transportation of wet and doughy materials. Standard outer diameter Ø 300mm. Ø 270mm - 10-5/8" → 350mm - 13-3/4" available on demand.



**USLT Unità Spazzolante Leggera**, con motore non in asse con la spazzola e sistema di fissaggio più leggero. Sono indicate per nastri trasportatori di dimensioni ridotte per lavori leggeri e quando vi sono difficoltà di installazione. Diametro esterno standard Ø 200mm - 7-7/8". A richiesta Ø 180mm - 7" → 260mm - 10-1/4".

**USLT Light Brushing Unit**, engine not in axis with the brush and lighter fastening system. They are recommended for smaller conveyor belts, for light working conditions and when there are installation constraints. Standard outer diameter Ø 200mm - 7-7/8". Ø 180mm - 7" → 260mm - 10-1/4" available on demand.



### Scelta dell'Unità Spazzolante / Brushing Unit Choice

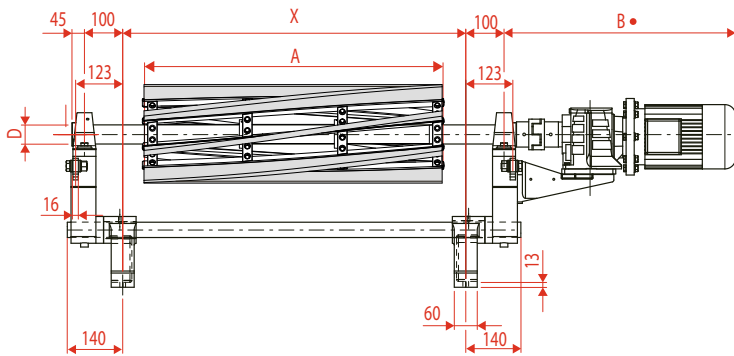

**UST:** Unità Spazzolante Normale con motoriduttore a flangia e regolazione a tirante / *Standard Brushing Unit with flange mounted gearbox and pulling rods*

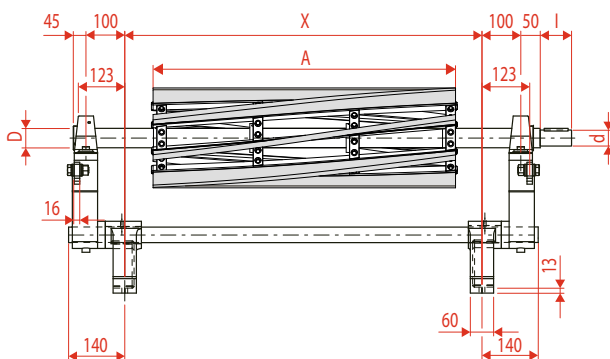
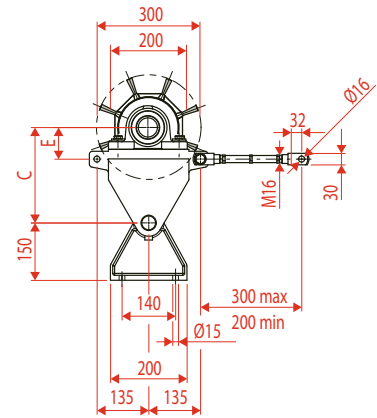

**UST:** Unità Spazzolante Normale senza motore per accoppiamento diretto al tamburo del nastro e regolazione a tirante / *Standard Brushing Unit without engine for direct coupling to the conveyor belt's drum and pulling rods*

#### Legenda

- L = larghezza nastro / belt width
- A = lunghezza utile spazzola / useful brush length
- D = diametro albero / shaft diameter
- d = diametro di traino / pulling bar diameter
- I max = lunghezza tratto di traino / pulling bar length
- X = interasse supporti / support's interaxis
- B = ingombro laterale motoriduttore / gear lateral dimension
- C = interasse barra-albero / bar-shaft interaxis
- E = interasse cerniere tiranti-albero / pulling rods-shaft interaxis
- HP = potenza motore [cavalli] / engine horse power

### Scelta delle Unità Spazzolanti Normali UST / Standard Brushing Unit UST choice

L	A	D	d	C	E	I max	X max	ART	200 - 400 RPM		> 400 RPM	
									HP	B	HP	B
400mm 15-3/4"	380mm 15"	35mm 1-3/8"	28mm 1-1/8"	240mm 9-1/2"	73mm 2-7/8"	60mm 2-3/8"	1000mm 39-3/8"	<b>UST400</b>	1	537mm 21-1/8"	1,5	604mm 23-3/4"
500mm 19-3/4"	480mm 18-7/8"	35mm 1-3/8"	28mm 1-1/8"	240mm 9-1/2"	73mm 2-7/8"	60mm 2-3/8"	1000mm 39-3/8"		1	537mm 21-1/8"	1,5	604mm 23-3/4"
600mm 23-5/8"	580mm 22-7/8"	35mm 1-3/8"	28mm 1-1/8"	240mm 9-1/2"	73mm 2-7/8"	60mm 2-3/8"	1000mm 39-3/8"	<b>UST600</b>	1	537mm 21-1/8"	1,5	604mm 23-3/4"
700mm 27-1/2"	680mm 26-3/4"	35mm 1-3/8"	28mm 1-1/8"	240mm 9-1/2"	73mm 2-7/8"	60mm 2-3/8"	1000mm 39-3/8"		1	537mm 21-1/8"	1,5	604mm 23-3/4"
800mm 31-1/2"	780mm 30-3/4"	40mm 1-5/8"	38mm 1-1/2"	242mm 9-1/2"	75mm 3"	80mm 3-1/8"	1325mm 52-1/8"	<b>UST800</b>	1,5	604mm 23-3/4"	2	629mm 24-3/4"
900mm 35-1/2"	880mm 34-5/8"	40mm 1-5/8"	38mm 1-1/2"	242mm 9-1/2"	75mm 3"	80mm 3-1/8"	1325mm 52-1/8"		1,5	604mm 23-3/4"	2	629mm 24-3/4"
1000mm 39-3/8"	980mm 38-5/8"	40mm 1-5/8"	38mm 1-1/2"	242mm 9-1/2"	75mm 3"	80mm 3-1/8"	1325mm 52-1/8"	<b>UST1000</b>	1,5	604mm 23-3/4"	2	629mm 24-3/4"
1100mm 43-1/4"	1080mm 42-1/2"	50mm 2"	42 1-5/8"	250mm 9-7/8"	83mm 3-1/4"	110mm 4-3/8"	1880mm 74"		2	629mm 24-3/4"	3	685mm 27"
1200mm 47-1/4"	1150mm 45-1/4"	50mm 2"	42 1-5/8"	250mm 9-7/8"	83mm 3-1/4"	110mm 4-3/8"	1880mm 74"	<b>UST1200</b>	2	629mm 24-3/4"	3	685mm 27"
1300mm 51-1/8"	1250mm 49-1/4"	50mm 2"	42 1-5/8"	250mm 9-7/8"	83mm 3-1/4"	110mm 4-3/8"	1880mm 74"		2	629mm 24-3/4"	3	685mm 27"
1400mm 55-1/8"	1350mm 53-1/8"	50mm 2"	42 1-5/8"	250mm 9-7/8"	83mm 3-1/4"	110mm 4-3/8"	1880mm 74"	<b>UST1400</b>	3	685mm 27"	4	706mm 27-3/4"
1500mm 59"	1450mm 57-1/8"	50mm 2"	42 1-5/8"	250mm 9-7/8"	83mm 3-1/4"	110mm 4-3/8"	1880mm 74"		3	685mm 27"	4	706mm 27-3/4"

## > Nastri trasportatori / Conveyor belts

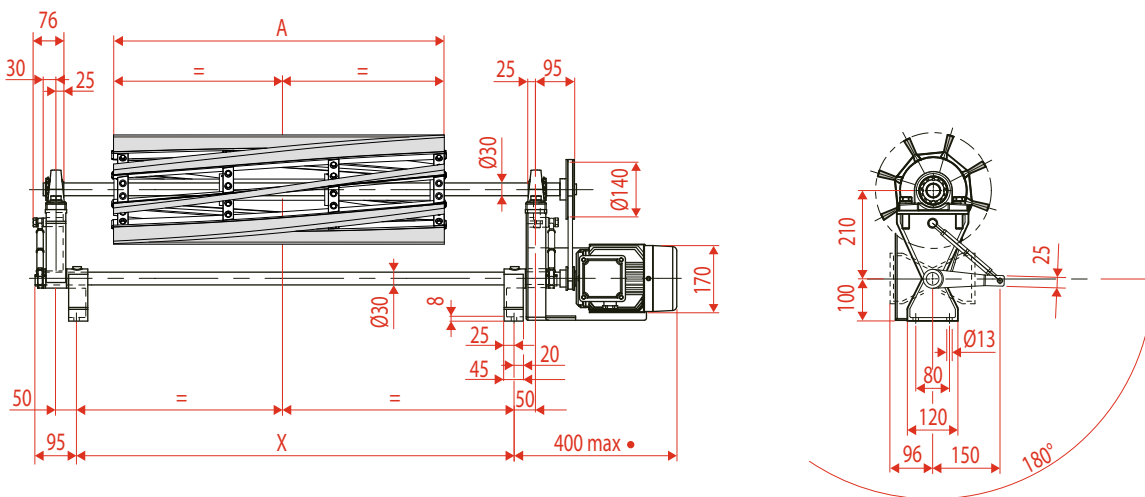

**USLT:** Unità Spazzolante Leggera con regolazione a tirante / Light Brushing Unit with pulling rods

### Scelta delle Unità Spazzolanti Leggere USLT / Light Brushing Unit USLT choice

L		A		X max		ART	RPM	HP
mm	inch	mm	inch	mm	inch			
400	15-3/4	380	15	600	23-5/8	<b>USLT400</b>	560	0,75
500	19-3/4	480	18-7/8	725	28-1/2	<b>USLT500</b>	560	0,75
600	23-5/8	580	22-7/8	850	33-1/2	<b>USLT600</b>	560	1
700	27-1/2	680	26-3/4	950	37-1/2	<b>USLT700</b>	560	1

#### Legenda

**L** = larghezza nastro / belt width

**A** = lunghezza utile spazzola / useful brush length

**X max** = interasse supporti / support's interaxis

### Parametri operativi del Nastro e dell'Unità Spazzolante / Belt's and brushing unit's operating parameters

Le Unità Spazzolanti devono essere montate parallelamente al nastro trasportatore, esattamente nel punto in cui il nastro lascia il tamburo di testa o immediatamente dietro la verticale dell'asse del tamburo curando l'allineamento dei supporti. Se si è costretti ad installare l'Unità Spazzolante in altre posizioni, occorre disporre un rullo folle contro l'altra faccia del nastro in modo che la spazzola agisca dove il nastro è teso.

L'alimentazione elettrica deve essere fatta in modo da assicurare l'avviamento e l'arresto della spazzola insieme al nastro trasportatore. È importante ricordare che sono le estremità dei filamenti che lavorano e quindi un'eccessiva pressione non farebbe altro che diminuire l'efficienza della spazzola e aumentarne il consumo.

The Brushing Units must be mounted in parallel with the conveyor belt, exactly where the belt leaves the head-drum or immediately behind the vertical axis of the drum making sure that the supports are aligned. If the Brushing Units are mounted in any other position, an idle roll must be placed against the other side of the belt, so that the brush operates where the belt is tight.

Power supply must be provided in order to start and stop both brush and conveyor belt at the same time. Keep in mind that the filament tips are constantly under working stress, therefore an excessive pressure would decrease the whole Unit's brushing effectiveness and accelerate the brush wear-out.



La foto indica la giusta flessione dei filamenti e la corretta pressione tra spazzola e nastro. / The picture shows the recommended bending stress of the filaments and the correct pressure between the brush and the belt.

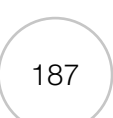
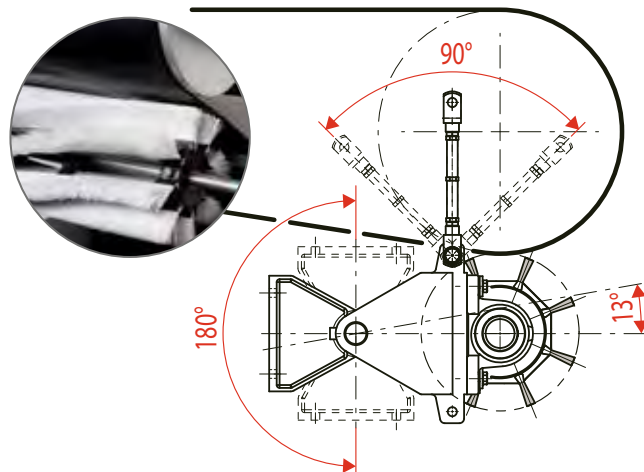



## SOLUZIONI TECNICHE / TECHNICAL SOLUTIONS

### > Nastri trasportatori / Conveyor belts

La **regolazione della pressione** si ottiene agendo su entrambi i tiranti laterali: operazione importante, anche per sopperire alla regolare usura dello strip mantenendo inalterata l'operazione di pulizia del nastro.

L'operazione di **sostituzione delle spazzole a strip** è molto semplice e la si effettua senza dover smontare l'albero. Allentando le viti che fissano i tasselli a coda di rondine le spazzole si possono sfilare sia lateralmente, sia radialmente, secondo le possibilità di accesso.

La **velocità di rotazione** della spazzola deve essere accuratamente scelta in funzione della velocità del nastro e del tipo di materiale da asportare. I sensi di rotazione della spazzola e del nastro devono essere opposti.

**Pressure** can be regulated by adjusting the pulling rods on both Brushing Unit's sides. This improves strip's life without effecting cleaning performance on the conveyor belt.

**Strip brushes replacement** is very simple and doesn't require the disassembling of the whole Unit. The wedges, held by a set of screws can be easily loosened, then strip brushes can be pulled out either sideways or radially at convenience.

The brush **rotational speed** must be carefully chosen in accordance to both the conveyor belt's speed and the type of material to be removed. Brush rotational direction must be opposite to the conveyor belt's one.

### Spazzole strip standard per UST e USLT / Standard strip brushes for UST and USLT

ART	Strip / Strip brushes	PPL Ø	H strip	S strip
UST	8 Strip base 14mm - 5/8"	0,8mm	70mm	55mm
	8 Strip brushes base 14mm - 5/8"	0,031"	2-3/4"	2"
USTL	8 Strip base 10mm - 3/8"	0,6mm	60mm	50mm
	8 Strip brushes base 10mm - 3/8"	0,024"	2-3/8"	2"

#### Legenda

**A strip** = altezza strip / strip length

**S strip** = sporgenza filo / wire trim length

\* A richiesta SIT offre diametri e tipi di filo differenti / Upon request different filament diameter and materials are available.

### RPM - Velocità - Materiale / RPM - Speed - Material



Diagramma per la scelta della velocità di una spazzola con diametro esterno di 300mm - 11-3/4" in funzione del tipo di materiale trasportato.

In ascisse: velocità del nastro in m/s - ft/min.

In ordinate: giri/min (RPM) della spazzola.

Per la scelta del riduttore arrotondare il valore della velocità al valore più vicino a quelli in commercio.

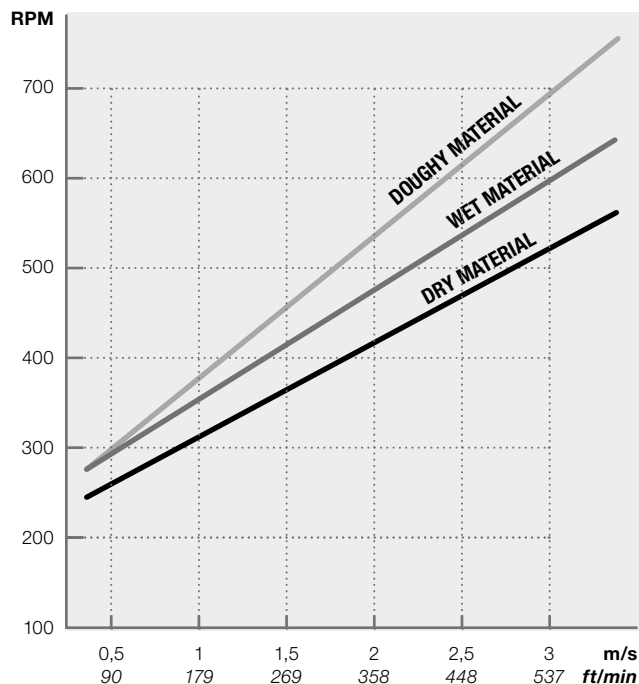
Diagram showing how to choose the correct speed when using a brush with 300mm - 11-3/4" outer diameter, depending on the conveyed material.

Abscissa: conveyor belt speed in m/s - ft/min. Ordinate: brush revolutions/min. (RPM).

In order to size the gearmotor, it's recommended to round up the speed value to the closest available in the market.

#### Legenda

**DRY** = Materiale secco / Dry material

**WET** = Materiale umido / Wet material

**DOUGHY** = Materiale bagnato e pastoso / Wet and doughy material

### Richiesta di offerta / Request for quotation

Per la Richiesta di Offerta delle Unità Spazzolanti occorre definire:

- Larghezza del nastro - Tipo di Unità Spazzolante
- Quota X (interasse dei piedini di fissaggio all'intelaiatura del nastro trasportatore)
- Materiale trasportato dal nastro e velocità in m/s
- Opzionale: velocità di rotazione della spazzola (vedi grafico)
- Opzionale: caratteristiche del motore elettrico / dell'ambiente

In order to define the right Brushing Unit for conveyor belt some variables have to be determined:

- Brushing Unit type - Belt's width
- X dimension (foot support's interaxis tied up to the conveyor)
- Conveyed material's type and nature and speed in m/s or ft/min
- Optional: Brush speed in RPM (see chart above)
- Optional: Electric engine size and specs and type of environment

## > Nastri trasportatori / Conveyor belts

### Documentazione / Documentation

Le unità spazzolanti sono conformi alla Direttiva Macchine 2006/42/CE. Per ogni unità spazzolante viene fornito il manuale d'istruzioni, il certificato di collaudo e la dichiarazione di incorporazione. Per ogni unità spazzolante possono essere forniti, su richiesta, i carter di protezione del giunto parastrappi per UST o della cinghia per USLT.

*Every Brushing Unit supplied by SIT complies with the Machinery Directive 2006/42/CE. Every Brushing Unit comes with a practical instruction manual, its test certificate, and the declaration of incorporation. Upon request protective equipment for the gearmotor and engine system can be provided (both for UST and USLT).*



### VANTAGGI DELLE UNITÀ SPAZZOLANTI / BRUSHING UNITS ADVANTAGES

Qualsiasi industria che utilizzi nastri trasportatori è sensibile al problema del materiale di ritorno (strato di materiale residuo che rimane aderente al nastro durante la fase di ritorno dopo lo scarico). Le Unità Spazzolanti SIT

- Evitano il consumo prematuro dei nastri trasportatori e dei componenti macchina a causa dell'accumulo di materiale di scarico intorno al nastro e dentro l'impianto
- Evitano la riduzione di efficienza dell'intero impianto
- Riducono i costi di manutenzione e pulizia
- Evitano la perdita di materiale costoso o la dispersione di materiale nocivo (può essere raccolto e riutilizzato e non disperso dentro il macchinario)
- Evitano la vibrazione ed il disassamento del nastro
- Evitano condizioni di lavoro poco sicure (ambiente di lavoro e macchine restano più puliti)

Questi problemi possono essere solo parzialmente risolti con raschietti standard ma in aggiunta le Unità Spazzolanti SIT.

- Non danneggiano i nastri (il filamento pulisce e non graffia)
- Sono più facili da sostituire (si sostituiscono solo le spazzole e non tutto il raschietto)
- Possono essere usate su qualsiasi tipo di sistema trasportatore, a nastro, a rullo, a tapparella, a catena, ...
- L'investimento iniziale diventa comunque economicamente conveniente in una prospettiva di Total Cost of Ownership (efficienza di pulizia, manutenzione nel lungo termine e tempi di setup)

*Every material handling industry and every conveyor belt have the material carryback problem (residual layer of material that sticks onto the conveyor even in the comeback section). SIT Brushing Units*

- *Avoid premature wear of conveyor belts and machine parts due to the material build up all around the conveyor belt and inside the machine*
- *Avoid the reduction in operating efficiency of the whole plant*
- *Reduce maintenance and cleaning costs*
- *Avoid expensive or hazardous material loss (can be gathered and reused and not lost inside the machine)*
- *Avoid belt's clogging and tracking problems*
- *Avoid unsafe working conditions (since working environment and machines are cleaner)*

*These problems can be partially solved with traditional scrapers but SIT Brushing Units.*

- *Don't damage at all the belts (filament tips do the cleaning and don't scratch the belt)*
- *Are easier to change (since only the brushes have to be changed, not the whole scraper)*
- *Can be used on any kind of conveyor, belt, roller, chain, ...*
- *Initial investment becomes anyway more convenient from a Total Cost of Ownership perspective (cleaning effectiveness, long term maintenance and changeover)*



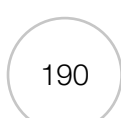

## SOLUZIONI TECNICHE / TECHNICAL SOLUTIONS

### > APPLICAZIONI INDUSTRIALI / INDUSTRIAL APPLICATIONS

# > Spazzole per ricostruzione pneumatici / Brushes for tyre retreading industry



Il "Retreading" è il processo di rigenerazione di pneumatici consumati, durante il quale viene mantenuto l'80-90% del materiale risparmiando un 80% del costo rispetto alla produzione di un nuovo pneumatico. Nel settore della ricostruzione pneumatici le spazzole sono fondamentali in ogni fase di lavorazione per garantire la qualità e la sicurezza del pneumatico rigenerato.

SIT offre un'ampia gamma di spazzole tecniche in acciaio ottonato ondulato e in cordicella d'acciaio ottonato Liz ideali per la spazzolatura della gomma.

"Retreading" is the process of replacing the tread on worn tyres in which it is saved and reused the 80-90% of the material and by which it is saved around 80% of the cost compared to the manufacturing of a new tyre. In the tyre retreading industry, brushes are fundamental in every re-manufacturing process in order to guarantee quality and safety of the re-treaded tyre.

SIT offers a wide range of technical brushes in crimped steel and in Liz brass-plated steel cord engineered and ideal for rubber brushing.

## 1 Ispezione iniziale e preparazione pneumatico da rigenerare / Initial inspection and preparation of the tyre to be retreaded

La carcassa dello pneumatico consumato viene inizialmente pulita da sassi, chiodi, vetri e sporcizia utilizzando spazzole circolari e a rullo con filamenti sintetici o metallici. Questa lavorazione è utile all'operatore per effettuare un controllo più preciso e sicuro della carcassa e per non sporcare l'impianto di ricostruzione. Dopo la pulizia iniziale, con l'ausilio di macchine automatiche, viene effettuata un'attenta ispezione manuale ed elettrica per giudicare l'idoneità dello pneumatico alla ricostruzione. In caso di esito positivo l'operatore ripara con spazzole alcuni punti prima di procedere alla rasatura.

The worn tyre casing is initially cleaned from stones, nails, glass and debris using wheel and roller brushes in synthetic or metallic filaments. This process allows the operator to be more precise and safe during the initial inspection and avoids the machines to get dirty. After the initial automatic cleaning a closer manual and electrical inspection takes place to verify the feasibility of the tyre retreading. If this is the case the user repairs with brushes some spots before the buffing step.

## 2 Rasatura della carcassa / Casing buffing

La rasatura, indispensabile per rimuovere la parte di battistrada che ha aderito alla carcassa, viene effettuata impiegando spazzole circolari in cordicella d'acciaio Liz (diametro da 100mm - 4" a 230mm - 9" e spessore da 15mm - 5/8" a 65mm - 2-5/8").

Dopo la sgrassatura con raspe metalliche le spazzole in Liz completano la pulizia della carcassa, spazzolando i fianchi e asportando residui di gomma dalla parte centrale; in questo modo si massimizza la prestazione su strada dello pneumatico. Per pulire i talloni delle carcasse si utilizzano spazzole circolari con profilo sagomato.

Buffing is the process by which all the old worn tread is removed before a new tread is applied to the casing. This is achieved with Liz steel cord wheel brushes (outer diameter from 100mm - 4" to 230mm - 9" and face width from 15mm - 5/8" to 65mm - 2-5/8").

After a set of metallic rasp blades shaves off roughly the tread Liz steel brushes are used to round completely the case, improving its surface finishing and cleaning the sidewalls in order to improve the final retreaded tyre performance on the road. Special shaped wire brushes are used to clean the tyre beads.

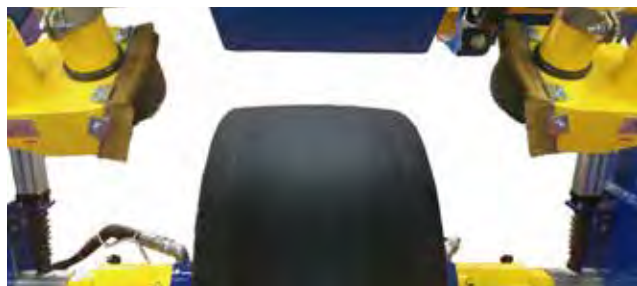

### Spazzole circolari per macchine raspatrici / Wheel brushes for buffing machines

D		E		S		C		MAX RPM		ART	Cordicella Liz Liz steel cord	Legenda D = diametro spazzola/ brush outer diameter E = spessore / face width S = sporgenza / trim length C = diametro foro / arbor hole diameter F = Vedi pag. 75 per le riduzioni standard. Si realizzano anche riduzioni speciali su disegno del cliente. / See page 75 for standard adapters. Special adapters can be realized on customer's drawing.
mm	inch	mm	inch	mm	inch	mm	inch					
100	4	23	7/8	11	1/2	38	1-1/2	6000	1	<b>RW 4103</b>	9600	
120	4-3/4	17	5/8	21	7/8	38	1-1/2	6000	1	<b>RW4122</b>	9601	
130	5-1/8	32	1-1/4	26	1	38	1-1/2	6000	1	<b>RW4134</b>	9602	
140	5-1/2	32	1-1/4	20	3/4	58	2-1/4	6000	1	<b>RW 6144</b>	9603	
150	5-7/8	23	7/8	36	1-1/2	38	1-1/2	6000	1	<b>RW 4153</b>	9604	
150	5-7/8	32	1-1/4	36	1-1/2	38	1-1/2	6000	1	<b>RW 4154</b>	9605	
150	5-7/8	18	3/4	25	1	58	2-1/4	6000	1	<b>RW 6152</b>	9606	
150	5-7/8	25	1	25	1	58	2-1/4	6000	1	<b>RW 6153</b>	9607	
150	5-7/8	32	1-1/4	25	1	58	2-1/4	6000	1	<b>RW 6154</b>	9608	
150	5-7/8	43	1-3/4	15	5/8	77	3	6000	1	<b>RW 8154</b>	9609	
160	6-1/4	43	1-3/4	20	3/4	77	3	6000	1	<b>RW 8164</b>	9610	
160	6-1/4	45	1-3/4	20	3/4	77	3	6000	1	<b>RW 8165</b>	9611	
160	6-1/4	50	2	20	3/4	77	3	6000	1	<b>RW 8166</b>	9612	
160	6-1/4	57	2-1/4	20	3/4	77	3	6000	1	<b>RW 8167</b>	9613	
170	6-3/4	22	7/8	20	3/4	77	3	6000	1	<b>RW 8172</b>	9614	
170	6-3/4	38	1-1/2	25	1	77	3	6000	1	<b>RW 8174</b>	9615	
180	7-1/8	45	1-3/4	30	1-1/4	77	3	6000	1	<b>RW 8185</b>	9616	
200	7-7/8	39	1-1/2	40	1-5/8	77	3	6000	1	<b>RW 8204</b>	9617	
200	7-7/8	50	2	40	1-5/8	77	3	6000	1	<b>RW 8206</b>	9618	
200	7-7/8	44	1-3/4	29	1-1/8	100	4	6000	1	<b>RW 10204</b>	9619	
225	8-7/8	30	1-1/4	25	1	77	3	6000	1	<b>RW 8223</b>	9620	
230	9	50	2	25	1	77	3	6000	1	<b>RW 8236</b>	9621	
230	9	57	2-1/4	25	1	77	3	6000	1	<b>RW 8237</b>	9622	
230	9	44	1-3/4	25	1	100	4	6000	1	<b>RW 10234</b>	9623	
230	9	55	2-1/8	25	1	100	4	6000	1	<b>RW 10236</b>	9624	

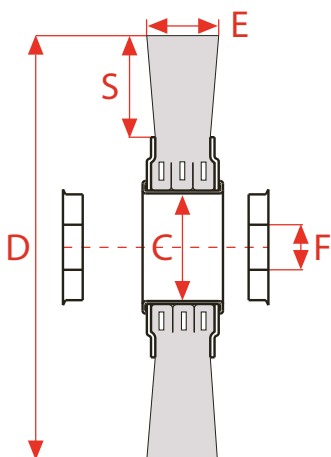

La texture ottenuta alla fine del processo di rasatura è importantissima per l'aderenza del nuovo battistrada che andrà applicato. Varia in base al tipo di ruota trattata e viene verificata con tabelle di controllo RMA (vettura privata → RMA 1-2, macchina movimento terra → RMA 2-3-4).

The casing texture left by the buffing process is critical for the adherence of the new tread to be applied. Buff texture to be achieved is different for the type of vehicle/tyre and is controlled with an RMA (Rubber Manufacturers Association) texture chart (passenger tyre → RMA 1-2, heavy duty tyre → RMA 2-3-4)



## > Ricostruzione pneumatici / Tyre retreading

### 3 Riparazione delle carcasse / Skiving and casing repair

Durante la riparazione delle carcasse vengono utilizzate spazzole circolari di diverso tipo, montate su utensili elettrici o pneumatici. Circolarine in acciaio ondulato, con diametro da 40mm - 1-5/8" a 80mm - 3-1/8", sono indispensabili per rimuovere la gomma da piccoli crateri dello pneumatico e smussarli prima che venga applicato il collante. L'uso di circolarine vulcanizzate, con diametro da 50mm - 2" a 70mm - 2-3/4", è invece particolarmente efficace nell'asportazione della gomma dalla rete metallica della carcassa e nella sua riparazione.

*During the casing repair the use of stem mount crimped wire wheel brushes with diameter from 40mm - 1-5/8" to 80mm - 3-1/8", mounted on power tools is necessary to remove rubber imperfections and to round down small tyre holes before cement is applied. The use of stem mount rubber bonded wheel brushes with diameters ranging from 50mm - 2" to 70mm - 2-3/4" on the other side is recommended for skiving and cleaning of the steel cord belts inside the casing.*



### 4 Raspatura del battistrada prestampato / Precured tread buffing



Per ottenere una perfetta aderenza alla carcassa della nuova fascia di battistrada è fondamentale irruvidire la parte interna del prestampato. L'operazione viene svolta con spazzole cilindriche ad altissima densità di filamento in Liz, montate su macchine spazzolatrici. Viene scelta una configurazione di fili diversa a seconda della percentuale di gomma presente nella nuova fascia; per spazzolature più marcate si usano monofili in acciaio ottonato.

*For a perfect tyre tread rubber bonding treatment, it is essential to roughen the precured tyre tread inner side. This is possible using high density Liz steel cord roller brushes or single section wheels mounted in proper brushing machines. According to the incidental percentage of rubber inside the replacing band/tread, Liz steel cords in various sizes are available. For a more aggressive brushing the choice of a single brass-plated steel wire is recommended.*

Nel caso di prestampato con alette (becco di flauto) si possono montare anche circolari larghe circa 60mm - 2-3/8" che aiutano ad irruvidire le alette concave ai lati del prestampato. Infine, per eliminare il polverino di gomma generatosi si usano spazzole cilindriche con filamenti in nylon.

*For pitched precured tyre tread other crimped wheel brushes 60mm - 2-3/8" wide can be recommended, especially for buffing the concave pitches located on the precured tyre tread band sides.*

*In order to get rid of rubber dust generated during the brushing session, it's possible to use nylon filament roller brushes*



### > Ricostruzione pneumatici / Tyre retreading

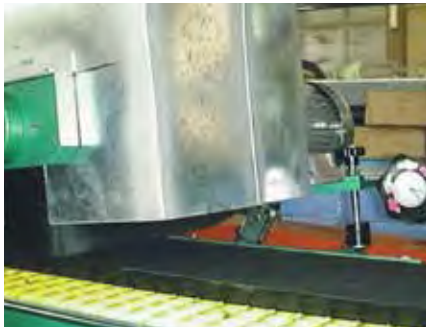

Pulizia del prestampato / *Precured tread cleaning*



Raspatura del prestampato / *Precured tread buffing*



### 5 Rullatura / *Building*

Spazzole cilindriche in filamento di nylon, opportunamente sagomate, servono per applicare la fascia di sotto strato sullo pneumatico (rullare). Inoltre con spazzole tecniche cilindriche in nylon di dimensioni più ridotte si può applicare la striscia antiscepolante sui fianchi della carcassa.

*Nylon cylindrical brushes, properly shaped, are used to build/add the lower layer on the tyre casing. Moreover, with other smaller sized roller brushes in nylon the anti-cracking sticky band can be applied on the casing sidewalls.*



### Altre Applicazioni / *Other applications*

Spazzole circolari o a pennello con gambo montate su utensili elettrici o ad aria vengono utilizzate per la pulizia degli stampi di vulcanizzazione nella ricostruzione a caldo.

*Wheel brushes or stem mount end brushes on electrical or pneumatic tools are used for the vulcanization mould cleaning in the hot retreading process.*



Spazzole lineari strip in crine o in ottone sottile montate su guaine di supporto sono utilizzate per la tenuta fumi, polveri e frammenti di gomma in tutte le macchine per pneumatici e per i processi di ricostruzione in generale.

*Moreover horse hair or thin brass strip linear brushes mounted on tapes are used in every tyre processing-retreading machine as smoke, dust and fragments of rubber or fluid sealing.*



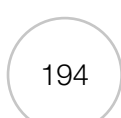
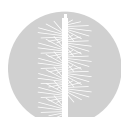

## SOLUZIONI TECNICHE / TECHNICAL SOLUTIONS

### > APPLICAZIONI INDUSTRIALI / INDUSTRIAL APPLICATIONS

# > Spazzole per trattamento legno / Brushes for woodworking



SIT, vista la crescente richiesta di prodotti spazzolati nell'industria del legno, presenta una gamma di articoli sviluppata insieme ai propri clienti per cogliere le esigenze più raffinate nella ricerca dei prodotti naturali come il legno per arredamento, pavimentazioni, soffitti, rivestimenti interni ed esterni.

*SIT, considering the growing request of brushed products in the wood industry, introduces a wide range of tools designed together with its customers looking for the finest finishing on natural wooden products for floors, furnitures, roofs, indoor and outdoor covering.*

### Rusticatura e strutturazione / Antique wood finishing, texturing

La spazzolatura del legno o "rusticatura" è il processo di lavorazione del legno tramite spazzole con lo scopo di conferirgli un aspetto più "rustico" e naturale al tatto ed alla vista rispetto ad una finitura liscia.

*Wood brushing or "antiquing" is the wood manufacturing process where industrial brushes are used to give the wooden plank a more "antique" and natural feel and appearance than a smooth wooden piece.*

È un processo che prevede preferibilmente almeno due passaggi di spazzolatura: una prima spazzola con filamento d'acciaio rimuove la parte morbida del legno evidenziando la venatura più dura. Successivamente una seconda spazzola in nylon abrasivo smussa i solchi rimuovendo le schegge e le imperfezioni lasciati dall'acciaio.

*It's recommended a two step (at least) brushing process: a steel wire brush digs the wood softer part highlighting harder grains. Then an abrasive nylon brush provides a finer finishing by removing burrs, chips and imperfections left by the steel wire brush.*

Per la rusticatura/strutturazione vengono prodotte spazzole con i seguenti filamenti:

*For aging-effect/texturing brushes with following filaments are recommended:*



Acciaio ondulato di diverse sezioni, comprese tra 0,20mm - 0,008" e 0,50mm - 0,020" / Crimped steel from 0,20mm - 0,008" to 0,50mm - 0,020" wire section



Cordicella di acciaio Liz, disponibile nelle sezioni 0,175mm - 0,007", 0,25mm - 0,010" e 0,30mm - 0,012" / Liz steel cord, available in wire sections: 0,175mm - 0,007", 0,25mm - 0,010" and 0,30mm - 0,012"



Nylon Abrasivo nelle grane 46, 60, 80, 120, 180, 320 / Abrasive Nylon in grits 46, 60, 80, 120, 180, 320

### Spolveratura e distribuzione vernici / Dusting and varnish spreading

Per la spolveratura e la distribuzione delle vernici si utilizzano spazzole con filamenti che hanno la peculiarità di non caricarsi elettrostaticamente in fase di lavoro, come:

*For dust removal and for painting/paint distribution SIT recommends the use of brushes with filaments that don't get electrostatically charged while working, like:*



Crine di cavallo / Horse hair



Tampico (fibra vegetale) che ha anche una leggerissima funzione abrasiva / Tampico (plant fiber) that also has a very light abrasive action

## > Lavorazione legno / Woodworking

Su richiesta del cliente le spazzole cilindriche sono realizzabili con diametri, lunghezze e filamenti diversi.

The cylindrical brushes can be manufactured with different diameters and lengths, as well as with different filaments based on a custom design

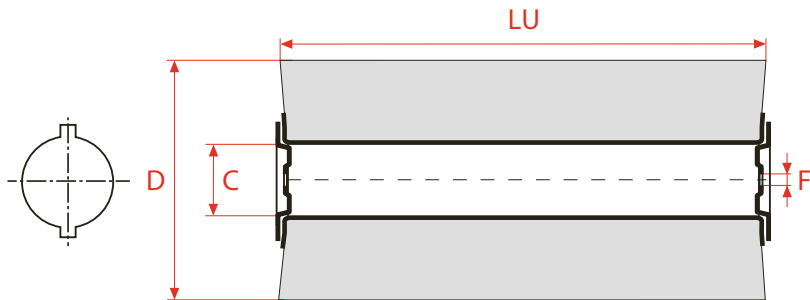

### Legenda

D = diametro esterno spazzola / brush outer diameter

LU = lunghezza utile / useful length

C = diametro tubo / tube diameter

F = diametro foro / arbor hole diameter

## Caratteristiche e variabili per la spazzolatura industriale delle diverse essenze legnose / Variables for the correct industrial brushing of different wood species

Il segreto che permette agli utilizzatori delle spazzole SIT di ottenere il risultato desiderato sulle varie essenze legnose, ruota intorno ad alcuni parametri.

- Velocità di avanzamento del nastro (o rullo) di lavoro che trasporta i profili che devono essere trattati
- Numero di spazzole in serie
- Tipologia dei filamenti
- Lunghezza dei filamenti
- Passo di avvolgimento (nel caso di spirali) o passo tra fori nel caso si tratti di spazzole punzonate
- Interferenza tra il filamento e la superficie del profilo in lavorazione
- Velocità di rotazione della spazzola
- Senso di rotazione della spazzola; in favore o contrario alla direzione di avanzamento del profilo.

The secret to allow users of SIT brushes to obtain the desired output on different wood species, relies on a few operating parameters.

- Conveyor belt (or roller) speed. This determines the wood profile feed rate
- Number of brushes in line
- Types of filament
- Filament trim length
- Winding pitch (for spiral brushes) or pitch between the holes (for staple set brushes)
- Interference (depth of penetration) between filaments and surface being processed
- Brush rotating speed
- Brush rotating direction: towards or against the profile feed direction.

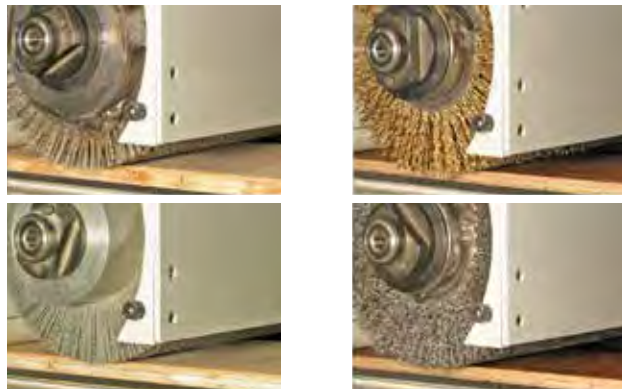

LARICE / LARCH



PINO / PINE



DOUSSIÉ / AFZELIA



FRASSINO / ASH



WENGÈ



ROVERE / DURMAST - OAK



TEAK



PINO MARITTIMO / CLUSTER PINE





> Unità Spazzolanti per il trattamento pannelli /  
*Brushing Units for panels treatment*

# > BRUSH GATE - Depolveratore compatto / *Compact web cleaner*

Brush Gate è un depolveratore con ingombro ridotto (sezione 100x120 mm), che può essere facilmente inserito in tutte le linee di lavorazione.

*Brush Gate is a compact web cleaner (cross-section 100x120 mm), that can be easily inserted in any production line.*

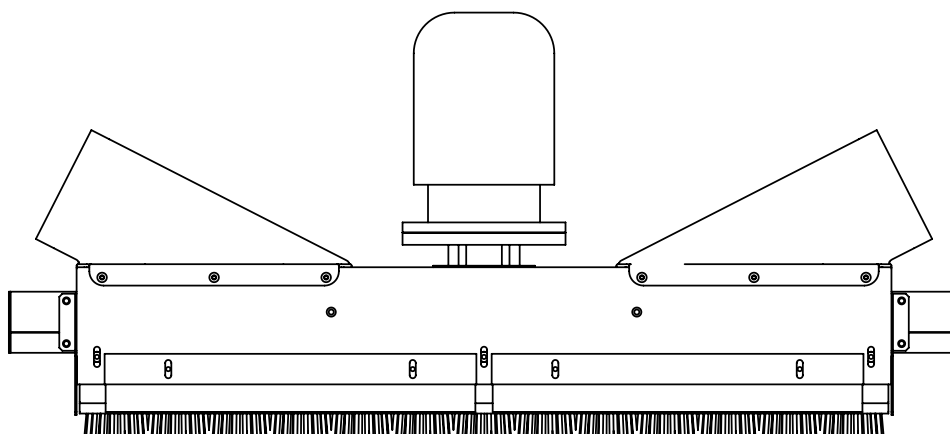

Una barriera di spazzole frontali cattura e smuove la polvere dai pannelli, mentre la cappa di aspirazione integrata la elimina. Le spazzole lavorano a secco, senza uso di liquidi. Questa è una caratteristica importante, in quanto i liquidi usati dalle macchine che lavorano ad umido danno diverse controindicazioni: costo, scarti di lavorazione quando termina il liquido, umidificazione del prodotto.

*A barrier of disc brushes collects and moves the dust, and in the meanwhile an integrated dust hood eliminates it. The machine works without fluids, very important feature because the fluids used into the wet machines give several problems: costs, defecting parts when the liquid ends, residues on the product.*

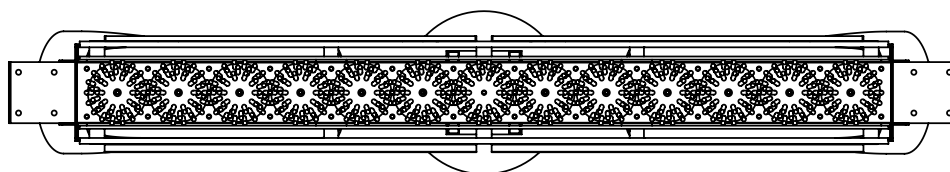

La velocità delle spazzole può essere facilmente regolata dal quadro di comando adattandosi alla velocità del pannello. Brush Gate è costruita in maniera modulare, potendo quindi coprire anche pannelli di grandi dimensioni con lo stesso limitato ingombro. I filamenti delle spazzole possono essere adattati ad ogni situazione e tipo di polvere, per ottenere il massimo dell'efficienza.

*The brush speed is easily adjustable from the control panel, adapting it to the line speed. Brush Gate is made in a modular way, so it can clean also great size panels with the same little cross section. Brush filaments can be adapted to any situation and dust, to improve system efficiency.*

## APPLICAZIONI / APPLICATIONS

Particolarmente indicato per il trattamento dei pannelli in legno, ma può essere utilizzato anche per lastre in plastica o, con spazzole opportune, per film.  
*Particularly suitable for the treatment of wood panels, but it can be used also for plastic plates and, with the right filaments, for film processing.*

### > Brush Gate

## > Modularità e personalizzazione / Modularity and customization

Per depolverare entrambe le facce del pannello si possono facilmente installare 2 macchine, semplicemente togliendo un paio di rulli di trasporto per fare posto al Brush Gate inferiore, come mostrato in figura.

To clean both sides of the panel, 2 machines can be easily installed on the line, simply eliminating a couple of transport rollers to give place to the lower Brush Gate, as displayed in figure.

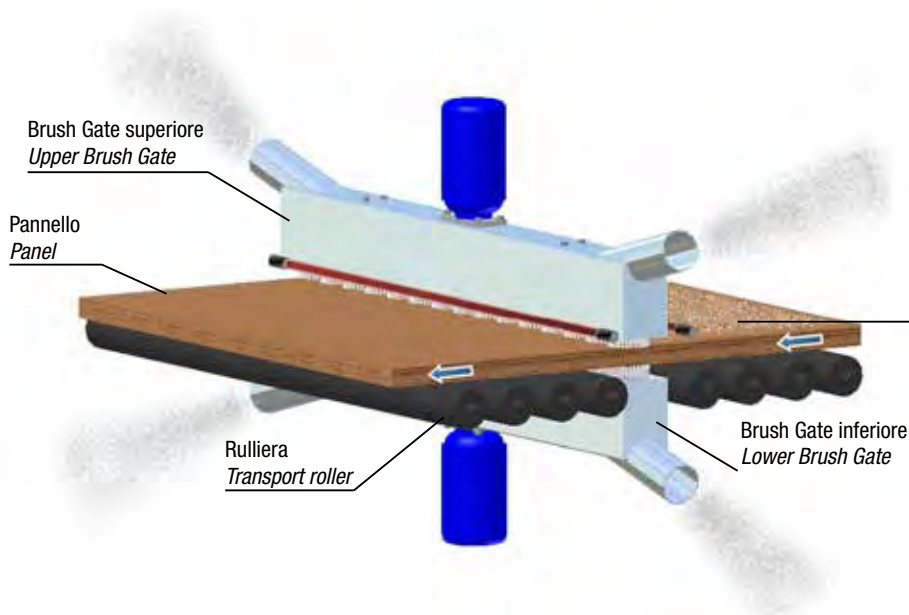

Brush Gate, a differenza di altri sistemi che lavorano unicamente sul piano, grazie alle spazzole frontali e con una speciale configurazione, può spolverare anche i bordi del pannello.

*Brush Gate, differently from other systems that work only on a plane surface, thanks to its disc brushes with a special setting can clean also the sides of the panel.*

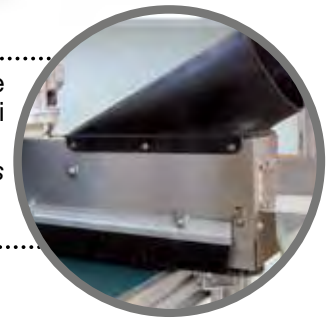

Il cliente può utilizzare il sistema di aspirazione già esistente sulla linea.  
*The customer can use the same suction system already existing on the line.*

Possono essere installate, come opzionali, una/due barre antistatiche, per la riduzione della carica elettrostatica che spesso rende difficoltoso il processo di pulizia.  
*It is possible to install, as optional, one/two antistatic bars, for reducing of the static charges that often create problems in the dusting process.*





### Test Area e rusticatrice / Test Area and brushing machine

All'interno della SIT è stata allestita una Sala Prove dotata di spazzolatrice/rusticatrice a 4 spazzole, prodotta da un importante costruttore italiano, e di una differenziata gamma di spazzole. Tale macchina, nata per la lavorazione superficiale del parquet, permette di testare l'ampia gamma di spazzole per la lavorazione industriale del legno e rispondere meglio alle esigenze del cliente.

Inside SIT manufacturing plant we installed a Test Area with a 4 brushing stations woodworking machine, provided by a leading italian manufacturer. This machine, originally manufactured for parquet flooring treatment, gives the possibility to test the wide range of industrial brushes for woodworking in order to satisfy SIT demanding customers.



### Spazzolatura manuale del legno / Manual wood brushing

SIT fornisce un'ampia gamma di spazzole a rullo che possono essere montate sulle macchine spazzolatrici delle più prestigiose marche (SCM, Costa, Griggio, Volpato, ...) per la lavorazione industriale del legno. Allo stesso tempo è disponibile un'ampia gamma di spazzole a rullo per le levigatrici manuali più diffuse come Makita, Festool, Flex e anche per le smerigliatrici angolari standard attraverso il nostro adattatore brevettato. Vedi pag. 85-89.

SIT supplies a wide range of roller brushes that can be mounted on the main wood brushing machines (SCM, Costa, Griggio, Volpato, ...) for industrial woodworking but also a wide range of roller brushes for wheel sanders that are one the most commonly used tools for antique wood finishing and texturing. Abrasive and steel (brass, stainless, Liz) roller brushes can be mounted on the main wheel sanders like Makita, Festool, Flex and normal angle grinder with our patented adapter. See page 85-89.



GUARDA I VIDEO  
WATCH THE VIDEO  
  
sitbrush.tv/wood1



### > APPLICAZIONI INDUSTRIALI / INDUSTRIAL APPLICATIONS

# > Spazzole per sbavatura tubi / Brushes for pipe deburring

Il taglio e la lavorazione di tubi, alberi, profili e di altri particolari metallici hanno sempre come prima conseguenza il problema della formazione di bave.

La flessibilità e l'adattabilità della superficie di lavoro fanno sì che la spazzola sia l'utensile ideale per tutte le operazioni di sbavatura.

L'esperienza di oltre 60 anni come SIT Tecnospazzole ci permette di offrire al cliente la spazzola ideale per qualsiasi esigenza di sbavatura metallica. Con le nostre spazzole per sbavatura è possibile rimuovere bave da profili di qualsiasi forma, a sezione circolare, rettangolare e anche più complessi, compatibilmente con la macchina sbavatrice utilizzata.

Il vantaggio che con la nostra esperienza offriamo al cliente è quello di una sbavatura sempre perfetta indipendentemente dalla specializzazione dell'operatore.

Le spazzole industriali SIT sono impiegabili con flessibilità per la sbavatura di tubi, barre, profili estrusi e bordi di lamiere in acciaio, acciaio inossidabile, alluminio e altri metalli non ferrosi.

*When cutting or processing either pipes, junctions, shafts, profiles and other metal parts is needed, the resulting burrs have to be removed from the piece.*

*Both flexibility and adaptability of the working surface identify the brush as the most suitable and ideal tool for every deburring operations.*

*More than 60 years of experience allows us, SIT Tecnospazzole, to offer to the customer the ideal brush for his deburring need. With our deburring brushes it's possible to remove burrs from profiles of every shape and section (circular, rectangular and also more complex) in compliance with the deburring machine used.*

*The main offered advantage is the perfect deburring independently from the qualification of the user.*

*The SIT industrial brushes can be used with flexibility for the deburring of tubes, bars, extruded profiles and sheet edges in steel, stainless steel, aluminum and other alloys.*



## Caratteristiche delle spazzole per sbavatura SIT / Characteristics of SIT deburring brushes

Per ogni tipo di applicazione SIT propone una spazzola per sbavare con caratteristiche di dimensione, densità, sporgenza e qualità dei filamenti tali da poter ottenere soluzioni ottimali nel rapporto qualità prezzo. In questo modo il cliente sostiene un costo minimo grazie alla spazzola adeguata che viene velocemente ammortizzata per i suoi lunghi tempi di durata. SIT offre una selezione di spazzole universali ad altissimo rendimento, adatte alle più svariate applicazioni di sbavatura. Fattori peculiari che contraddistinguono le spazzole SIT:

- Perfetta cilindricità e alta precisione del prodotto finale
- Perfetta rasatura della superficie e arrotondamento uniforme dei bordi
- Altissima densità dei filamenti
- Completa eliminazione dei residui di bava principale e di bave secondarie (non serve rifinitura manuale aggiuntiva)
- Altissima resistenza alla trazione dei filamenti utilizzati
- Accurata equilibratura dinamica (con certificato)

*For every type of application SIT offers a deburring brush with the size, density, trim length and filament type to get the best quality/price ratio. In this way the customer has a minimum cost that is quickly amortized thanks to the higher efficiency and longer brush life.*

*The Deburring Solutions product range by SIT includes a selection of industrial brushes for the toughest and finest deburring applications.*

*Characteristics of these brushes:*

- Perfect cylindricality and high precision of the finished product
- Perfect surface trimming and uniform rounding of the borders
- Very high filling density
- No additional manual finishing operations required since there is no residual burr or secondary burr
- Very high traction resistance of the filaments used
- Accurate dynamic balancing (with certificate)





## > Sbavatura / Deburring

### Spazzole per sbavatrici automatiche o manuali / Brushes for automatic or manual deburring machines

Le spazzole per sbavare SIT possono essere montate su qualsiasi tipo di macchinario: spazzole circolari per sbavatrici manuali, spazzole a rullo per sbavatrici meccaniche/automatiche delle più importanti marche (Adige, Bewo, ecc) e anche spazzole a segmento per sbavatrici RSA.

*SIT deburring brushes can be mounted on every type of machine: wheel brushes for manual deburring machines, roller brushes for mechanical/automatic deburring machines of the most important brands (Adige, Bewo, and more) as well as segment brushes for RSA deburring machines.*



### Sbavatura manuale / Manual deburring

(Vedi anche pag. 73 / see also page 73)



### Sbavatura automatica / Automatic deburring



### Sbavatura di profili complessi con spazzole a segmento / Complex profiles deburring with segment brushes

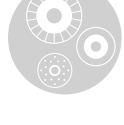
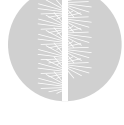

## > Sbavatura / Deburring

### Consigli per la regolazione delle spazzole / Brush setting recommendations

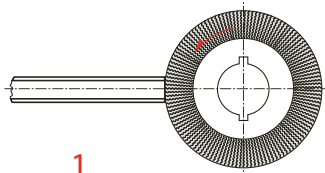

Per una sbavatura interna ed esterna normale, l'asse del tubo deve trovarsi in corrispondenza di quello della spazzola.  
For a standard internal and external deburring, the tube axis must be aligned to the brush axis.

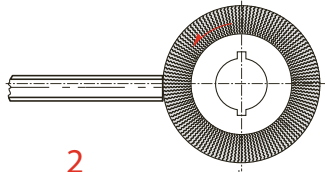

Sbavatura esterna: quando la bava è maggiore nel diametro esterno, l'asse del tubo o della barra va portato leggermente al di sotto dell'asse della spazzola.  
Outer deburring: when the burr is larger on the external diameter, the axis of the tube or bar must be placed slightly below the axis of the brush.

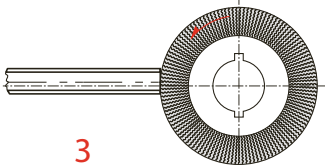

Sbavatura interna: quando la bava è maggiore nel foro del tubo, l'asse del tubo deve essere portato leggermente al di sopra dell'asse della spazzola.  
Inner deburring: When the burr is larger in the inner diameter of the tube, the axis of the tube must be placed slightly above the axis of the brush

	D		Velocità di esercizio consigliate [RPM] Recommended RPM
	mm	inch	
Sbavatura automatica / Automatic deburring	300	11-3/4	800 - 1200
Sbavatura manuale / Manual deburring	250	9-7/8	1000 - 1200

### Scheda tecnica spazzole per sbavare tubi e profili / Brushes for pipes and profiles deburring technical datasheet

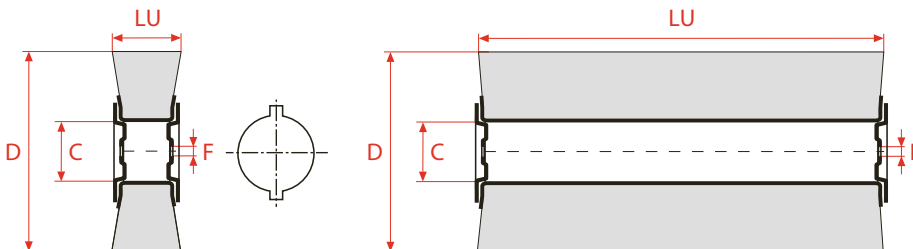

D		LU		C		F	Acciaio / Steel			Inox / Stainless steel		
mm	inch	mm	inch	mm	inch		0,20mm 0,008"	0,35mm 0,014"	0,50mm 0,020"	0,20mm 0,008"	0,35mm 0,014"	0,50mm 0,020"
250	9-7/8	50	2	100	4	1	X	X	-	-	X	-
250	9-7/8	60	2-3/8	100	4	1	-	X	-	-	X	-
250	9-7/8	120	4-3/4	100	4	1	-	X	-	-	X	-
300	11-3/4	50	2	120	4-3/4	1	-	X	-	-	-	-
300	11-3/4	60	2-3/8	120	4-3/4	1	-	X	-	-	-	-
300	11-3/4	440	17-3/8	120	4-3/4	2	-	X	-	-	-	-
300	11-3/4	440	17-3/8	120	4-3/4	2	X	X	-	X	X	-
300	11-3/4	600	23-5/8	120	4-3/4	2	-	X	-	-	-	-
350	11-3/4	440	17-3/8	120	4-3/4	2	-	-	-	-	-	-
350	11-3/4	600	23-5/8	120	4-3/4	2	-	-	-	-	-	-

A richiesta sono disponibili filamenti di acciaio ottonato, cordicella Liz e inox / Upon request, brass coated wire, Liz steel cord and stainless steel wire are available

D = diametro esterno spazzola / brush outer diameter  
LU = lunghezza utile / useful length  
C = diametro tubo / tube diameter  
F = diametro foro / arbor hole diameter

F=1 = riduzione in lamiera / metal sheet adapter  
F=2 = riduzione in ferro tornita e smontabile / lathed and removable iron adapter  
X = disponibile / available  
- = a richiesta / on request



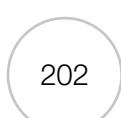
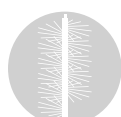

# > Spazzole per settore pipeline / Brushes for the pipeline industry



Nel settore **Pipeline** la spazzolatura ricopre un aspetto molto importante nelle varie fasi di lavorazione, dalla produzione dei tubi alla loro messa in opera (a terra oppure offshore). SIT offre un'ampia gamma di **spazzole di altissima qualità** testate ed apprezzate in tutto il mondo.

*In the **Pipeline** industry, from pipes' manufacturing to their posing on the ground or offshore, the brushing treatment holds a very relevant aspect of each working cycle. SIT offers a wide range of **very high quality brushes** tested and appreciated worldwide.*

## Preparazione del cianfrino e pulizia delle saldature / Chamfer preparation and weld cleaning

La preparazione del cianfrino e la pulizia del cordone di saldatura sono operazioni importantissime nella fase di posa in opera del pipeline. Le condizioni di lavoro non sempre ottimali necessitano del massimo rendimento degli utensili da lavoro. Oltre ad una maggiore efficacia di lavorazione (rimozione completa dell'ossidazione in ogni strato della saldatura), la scelta di una spazzola performante comporta anche un minor consumo ed un conseguente risparmio nei tempi di set-up per la sua sostituzione. Rispetto ai dischi abrasivi le spazzole sono molto più efficaci perché puliscono solo l'ossidazione della saldatura lasciando la base del cordone intatto; sono inoltre meno rumorose e producono meno scintille quindi sono più sicure!

*Weld seams preparation and cleaning are very important in the pipeline posing process. The typical hard working environment requires maximum performance of the used tools.*

*The choice of the brush as a weld cleaning tool affects a higher efficiency (complete welding debris removal on every single layer) a longer service life and the resulting savings during the brush replacement. Compared to abrasive discs for weld cleaning, brushes are way more effective, cleaning only the welding debris and leaving the welding material base untouched; they are also less noisy and they generate less sparks so being a safer tool!*

### Vantaggi

- **risparmio economico** - costi minimi di ri-lavorazione e setup
- **maggiore sicurezza dell'operatore** - meno scintille e poco materiale/filamento perso (o nessuno nel caso di spazzole vulcanizzate)

### Advantages

- **economical savings** - minimum re-working costs, less setup
- **user safety** - less sparks and less or no (for encapsulated brushes) material/filament loss

Si individuano 4 tipologie principali di spazzole per i lavori di pulizia saldatura e preparazione del cianfrino.

*There are 4 main types of brushes for the weld cleaning the chamfer preparation.*



### Circolari UZ

Le spazzole della serie UZ, nei diametri da 115mm - 4-1/2" a 178mm - 7" sono create per spazzolare la prima passata di saldatura e sono anche adatte all'asportazione di scorie all'interno di fessure di piccole dimensioni. Le caratteristiche chimiche e meccaniche del filo di acciaio, unite alla qualità della costruzione della spazzola, consentono ottimi risultati per aggressività e durata. Vedi pag. 39.

### Wheel brushes UZ

*UZ series brushes, with diameters from 115mm - 4-1/2" to 178mm - 7" are designed for the first welding layer brushing and they are also suitable for the removal of slugs inside every type of small slot. The chemical and mechanical characteristics of the steel (or stainless steel) wire, along with the outstanding engineered manufacturing process offer the users both high results for aggressiveness and durability. See page 39.*

## > Pipeline

### Circolari CV

Le spazzole circolari vulcanizzate della serie CV sono costituite da un anello di filo d'acciaio ottonato annegato in una matrice poliuretanica. Principali caratteristiche sono:

- consumo regolare dei filamenti,
- spessore costante del bordo abrasivo,
- mancanza di rottura dei filamenti → maggior sicurezza dell'operatore.

Vedi pag. 40.

### Circolari U

Le spazzole circolari a mazzetti ritorti della serie U, nei diametri da 100mm - 4" a 180mm - 7", sono particolarmente adatte per le passate successive di saldatura e per asportare scorie tenaci. Vedi pag. 38.

### Tazze TU

Spazzole a tazza a mazzetti ritorti, nei diametri da 70mm - 3-3/4 a 150mm - 6", a uno o due ranghi di mazzetti ritorti. Sono adatte a rimuovere residui particolarmente resistenti da superfici piane. Vedi pag. 27-29.

SIT offre spazzole con diversi tipi di mazzetto ritorto ciascuno ingegnerizzato e ottimizzato per una specifica lavorazione. Vedi pag. 18.

### Wheel brushes CV

CV series of encapsulated/vulcanised wheel brushes are made of a steel wire wheel ring bonded into a polyurethane solution. Main characteristics are:

- regular trim wear out,
- constant and regular abrasive face width,
- no filament breakage → higher user safety.

See page 40.

### Wheel brushes U

Twisted knots wheel brushes of the U series, with diameters from 100mm - 4" to 180mm - 7", are especially suitable for the second welding layer and for the removal of tenacious slags. See page 38.

### Cups TU

Twist knot cup brushes, with diameter from 70mm - 3-3/4 to 150mm - 6", with both 1 and 2 twist knot rows. They are suitable for the weld cleaning and thick slags removal over plain or lightly curved surfaces. See page 27-29.

SIT twist knot brushes can be manufactured with different twist knot types, each one engineered for a specific operation. See page 18.

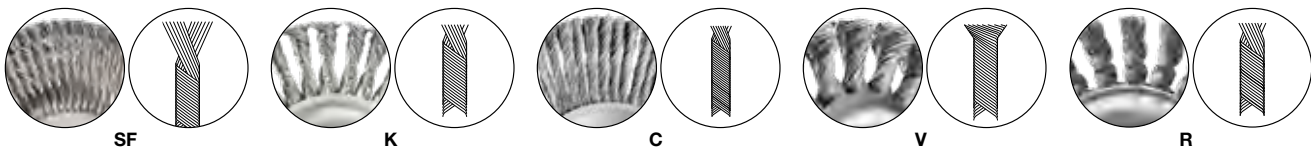

## Asportazione rivestimento tubi - CutBack / Pipe coating removal – CutBack



L'asportazione del rivestimento in polietilene (PE), polipropilene (PP) e resine epossidiche dalla testata di tubi è un'operazione critica ed una spazzola performante incide fortemente sulla produttività e sulla qualità dell'output. Per questa applicazione vengono utilizzate spazzole circolari a mazzetti ritorti in acciaio temprato di qualità superiore composte da più anelli forniti sia singolarmente sia già assemblati (ANU).

Le 3 operazioni necessarie per pulire il cianfrino, la fascia cilindrica e realizzare il becco di flauto sono eseguite contemporaneamente da un'unica spazzola a rullo con anelli di diverso diametro. Una parte degli anelli spesso è vulcanizzata per una migliore performance.

Le spazzole a rullo per la pulizia di tubi rivestiti sono fornite con nuclei forati per un eventuale refrigerazione ad aria in modo da sostenere elevatissime temperature ed aumentare la vita utile della spazzola.

Polyethylene (PE), polypropylene (PP) or epoxy resin coating removal from the pipe ends is a critical operation and a performing brush strongly affects the productivity and the output quality. Very high quality twist knot roller brushes in tempered steel made of several single section wheels provided both separately and assembled (ANU) are required for these processes.

The 3 operations of bevel cutting, cutback and edge cleaning are carried out in one step only by the same roller brush made of wheels of different diameter. Some of these brushes can be encapsulated for an increased performance.

Coated pipe cleaning roller brushes are supplied with special drilled cores in order to allow an eventual air cooling system in order to support very high temperatures and increase brush service life.



## > Pipeline



Spazzola a mazzetti ritorti che lavora su una testa di tubo / *Twisted knot brush processing a tube end*



Spazzolatura di una testata di tubo con 2 rulli / *Coating removal with 2 perpendicular roller brushes*



Sezione di tubo rivestito impiegato nel settore petrolifero / *Coated pipe section for the Oil&Gas industry*



Macchinario per il trattamento del cianfrino / *Chamfer processing machine*



Spazzola a mazzetti ritorti per il cutback / *Twisted knot cutback brush*



Testa di tubo spazzolata in una stazione di linea automatica / *Pipe head inside a cutback automatic station*



Mazzetti ritorti in acciaio temperato SIT di alta qualità / *High quality tempered steel twist knot brushes*



Spazzola a rullo per l'industria del Pipeline / *Roller brush for the Pipeline industry*



Testata dopo il trattamento di spazzolatura / *Pipe chamfer properly brushed*

## Produzione del tubo pre-rivestimento / *Pipe manufacturing prior to coating process*

Nel processo di produzione dei tubi vengono utilizzate spazzole a filo ondulato flessibile montate in linea per mantenere il contatto elettrico continuo tra la torcia di saldatura ed il tubo in movimento durante l'operazione di chiusura del tubo. Le migliaia di filamenti metallici garantiscono il contatto continuo evitando interruzioni ed imperfezioni di saldatura.

*In the pipe manufacturing process many crimped steel wire brushes are used to maintain continuous electric contact between the welding nozzle and the moving steel pipe inside pipe welding units. Thousands of filaments ensure continuous contact avoiding interruptions and imperfections of the weld seam.*



## > Pipeline

Nel processo immediatamente precedente al rivestimento tubi in alternativa ai classici rulli poliuretanic (PU) vengono preferite rulliere ad anelli a mazzetti ritorti per il trasporto del tubo soprattutto in prossimità delle zone calde (forni ad induzione). Il tubo in queste fasi raggiunge temperature superiori ai 150 °C - 302 °F. Rulli di trasporto in poliuretano a queste condizioni si ammorbidiscono, si deformano e si danneggiano facilmente rendendo necessaria una sostituzione frequente (interruzione dell'impianto). I rulli di trasporto a spazzola (drive roll) invece, con superficie rasata regolare ed alta densità di filamento, non risentono di queste condizioni di lavoro gravose, non rovinano il tubo, sopportano le vibrazioni generate dalla rotazione del cordone di saldatura e hanno una vita utile diverse volte superiore ai rulli PU. Esistono anche rulli alternativi in acciaio che però schiacciano la superficie modificando la rugosità e compromettendo l'aderenza del rivestimento. Le spazzole consentono quindi un risparmio economico ed un ritorno sull'investimento immediato per il minor numero di setup ed il minor tempo di fermo impianto.

*Prior to coating process the pipe has to be transported through induction heating sections (ovens). Roller brushes made of single section twist knot wheels are recommended as an alternative to polyurethane (PU) rollers commonly used. Indeed inside induction heating the pipes leaves the oven at a temperature higher than 150 °C - 302 °F. Polyurethane rollers at these temperatures get soft and damaged and wear out quickly requiring a frequent replacement (plant downtime). Transport roller brushes (drive roll brushes) on the other side, with a perfectly trimmed surface and a very high fill density, don't suffer these hard working conditions, they absorb vibrations of the welding seam rolling, they don't damage the pipe and they have a service life many times higher than PU rollers. There are also metallic drive rolls but they change the pipe surface roughness damaging the adherence of the coating. This way brushes ensure an economical saving and an immediate return on investment (less setups and lower plant downtime).*

## Ispezione post rivestimento / Post coating inspection: holiday detector

Per i clienti che richiedono massima affidabilità anche durante le fasi di ispezione SIT offre spazzole capaci di adattarsi alla superficie di ogni tubo permettendo al meccanismo di ispezione di rilevare anche la minima imperfezione.

Queste spazzole sono strip con filamento lungo e flessibile, curvati a fili interni per assicurare il contatto continuo senza danneggiare il rivestimento ed adattandosi a tubi di diverso diametro.

*For customers requiring maximum reliability in detecting flaws, SIT proposes brushes able to adapt perfectly to each pipe's surface allowing the available testing equipment to discover the minimal imperfection.*

*These strip brushes have soft and long stainless steel wire which ensures electric contact without damaging the coating and adapting to different pipe diameters.*



## Gunitatura: il rivestimento di tubi a calcestruzzo proiettato / Concrete coating, weight coat/compression coat/shotcrete on pipes

L'operazione di gunitatura consiste nella formazione di uno strato di cemento sulla superficie esterna del tubo. È particolarmente rilevante nel caso di condotte sottomarine dove, per evitare il galleggiamento, si appesantisce il tubo con un rivestimento in calcestruzzo retinato, in genere gunitate (gunitatura esterna). Oltre alla funzione di appesantimento lo strato di cemento fornisce anche una protezione passiva alla corrosione. La gunitatura esterna viene effettuata mediante un macchinario speciale con spazzole a rullo che proiettano il cemento sopra al normale rivestimento del tubo (epossidico, bituminoso, polietilenico ecc...). La spazzola è formata da anelli "INCO" in acciaio ondulato ad altissima resistenza.

*Concrete weight coating is the operation of projecting at high speed a layer of concrete with fiber reinforcement over the external surface of the pipe. It's widely used and recommended for underwater/subsea pipelines in order to avoid flotation since buoyancy force is higher than the pipe weight.*

*Shotcrete can be applied over any anti-corrosion and insulation coating systems giving "weight" (negative buoyancy) and giving also a special passive corrosion protection.*

*Concrete is sprayed on the pipe's surface with a special machine (side wrap application) mounting a technical roller brush made of very high resistance crimped wire single section wheels (INCO).*



GUARDA IL VIDEO  
WATCH THE VIDEO  
  
sitbrush.tv/pipe1



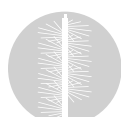

## SOLUZIONI TECNICHE / TECHNICAL SOLUTIONS

### > APPLICAZIONI INDUSTRIALI / INDUSTRIAL APPLICATIONS

# > Spazzole per fonderia / Brushes for foundry industry



Nella fonderia il problema della pulizia dei residui di terra risulta una delle applicazioni nelle quali la spazzola è elemento fondamentale. Utilizzare sistemi di pulizia a spazzole prodotti da SIT evita successive costose operazioni di manutenzione o sostituzioni di impianti.

*In the foundry industry one of the ultimate applications of the brush concerns the removal of moulding sand (loam sand). SIT Foundry Solutions is the range of industrial brushes designed with our customers to avoid very expensive maintenance operations and to keep the plant running smoothly.*

### Pulizia interna delle staffe / Inner clips' cleaning

Vengono utilizzate delle spazzole lineari il cui elemento spazzolante è costituito da mazzetti ritorti in acciaio ad altissima resistenza. La serie di mazzetti viene fissata ad un supporto di acciaio opportunamente dimensionato rispetto alle varie forme delle staffe di ogni impianto.

*It's possible to use linear strip brushes where the brushing component is represented by high resistance hardened steel twist knots. The twist knots array is firmly fixed onto a steel support properly shaped and profiled in accordance to the different types and dimensions of the clips.*

Il sistema consente un'efficace pulizia dei lati e degli angoli delle staffe mediante i mazzetti disposti su tre ranghi ed inclinati progressivamente in prossimità degli spigoli.

*This unit assures a reliable and effective cleaning of both clips' sides and corners as twist knots are disposed on three rows and progressively on a slant when the distance to the edges decreases.*

L'operazione di spazzolatura può essere eseguita contemporaneamente alla fase di distaffatura oppure in una fase successiva, predisponendo una stazione apposita.

*The brushing session can be done simultaneously during the clipping phase or after, by setting a proper working station up.*

La manutenzione della spazzola può essere eseguita rapidamente all'interno della fonderia stessa; è sufficiente sostituire i mazzetti consumati estraendoli dal supporto e inserendo i nuovi con l'apposita pinza da SIT fornita.

*The brush's maintenance can be done rapidly inside the foundry, replacing the worn twist knots out of the support and inserting the new ones using dedicated pliers supplied by SIT along with the brushing unit.*



### Spazzolatura del bordo superiore ed inferiore delle staffe / Upper and lower clip edges' cleaning

La pulizia viene eseguita con spazzole lineari in filo ondulato o a mazzetti ritorti in acciaio ad altissima resistenza, la tipologia della staffa consente sempre una rapida manutenzione e sostituzione anche solo dei mazzetti consumati.



*Linear strip brushes in crimped steel wire and high resistance steel wire twist knots can be both used for this purpose.*

*Again the brush is engineered to allow a fast and easy maintenance and replacement of the worn out knots.*

### > Fonderia / Foundry

## Pulizia e spazzolatura dei caroselli e delle pianette / *Balancing surfaces' and melt cast iron casing cleaning*

La spazzolatura delle pianette e dei caroselli può essere eseguita con un sistema a spazzola traslante oppure con un sistema a spazzola rotante.

*Translating brushes or rotating brushes ensure the performance of this phase: cleaning carousels.*

Il sistema a spazzola traslante utilizza una spazzola rettilinea a mazzetti ritorti fissata ad un telaio mobile che trasla sulla parte superiore del carosello fermo.



*The translating brush system uses a linear brush with twisted knots firmly fixed to a moving frame that performs a translating action on the upper surface of the carousel that must be steady.*

Il sistema a spazzola rotante esegue la pulizia del carosello tramite una spazzola a settori elicoidali montata trasversalmente e operante a carosello in movimento.



Vedi Rulli Master a pag. 156 e Unità Spazzolanti a pag. 184.

*The rotating brush system cleans the carousel with a helical segments brush, properly transversely mounted and operating while the carousel keeps moving.*

*See Master Rolls at page 156 and Brushing Units at page 184.*

## Spazzolatura degli stampi a conchiglia / *Shell moulds cleaning*

Negli impianti shell moulding, la pulizia del piano del serbatoio di sparo può essere eseguita efficacemente utilizzando strip lineari in filo d'acciaio.



*The gunning tank's surface cleaning inside shell moulds is assured by a steel wire strip brush.*

## Pulizia dei pesi di stampaggio / *Weights cleaning*

Per una perfetta pulizia dei pesi possono essere utilizzate spazzole UST che consentono di ottimizzare la pressione di lavoro in rapporto alle necessità di pulizia.

*Even in this phase of the process SIT recommends the use of UST industrial Brushing Units in order to adjust and optimize brushing pressure (related to cleaning needs and requirements). See also page 184.*

Vedi anche pag. 184.

## Pulizia dei nastri trasportatori / *Conveyor belts cleaning*

Nella fonderia vengono utilizzati ampiamente nastri trasportatori per la movimentazione di materiali. Questi vanno spazzolati per evitare l'ingresso di sporco, polveri e residui più grossi all'interno dei macchinari, che possono peggiorare sicurezza e qualità di lavorazione e di output. Vedi anche pag. 184.

*In the foundry industry conveyor belts are widely used to move moulds, carriages and products. These must be brushed to keep dirt, dust and larger residues away from the gears of the machinery, as this would affect quality, safety and efficiency. See also page 184.*



Le spazzole SIT quindi permettono nel lungo termine di risparmiare sui costi di manutenzione e di avere maggiore efficienza complessiva.

*SIT brushes therefore allow a saving in maintenance costs and to keep an overall better efficiency.*



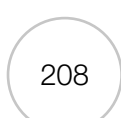
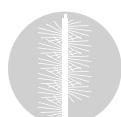

## SOLUZIONI TECNICHE / TECHNICAL SOLUTIONS

### > APPLICAZIONI INDUSTRIALI / INDUSTRIAL APPLICATIONS

# > SUNNY BRUSH - Spazzola per pannelli fotovoltaici e solari / *Brush for photovoltaic and solar panels*



I pannelli necessitano sempre di una pulizia periodica per evitare che, a causa di polveri di vario genere e dell'accumularsi dello sporco, venga ridotta la loro efficienza energetica. SUNNY BRUSH è la soluzione modulare che si adatta a tutte le diverse tipologie di pannelli esistenti in commercio.

#### VANTAGGI:

- **Modularità:** possibilità di ordinare la spazzola della lunghezza desiderata, ad hoc per il pannello
- **Facilità di assemblaggio:** anche direttamente sul tetto utilizzando semplici viti
- **Convenienza economica**
- **Semplicità di trasporto**
- **Facilità di sostituzione**

SUNNY BRUSH si compone di:

- un nucleo in alluminio in moduli da 1.000 mm
- Spazzola D=200 mm in nylon in moduli da 100 mm
- Boccole di giunzione in POM-C con inserti filettati
- Collari di bloccaggio e finitura delle estremità

*Solar panels always require periodic cleaning in order to prevent that, due to dust of various kinds and the accumulation of dirt, their energy efficiency is reduced.*

*SUNNY BRUSH is the modular solution that is suitable for all different types of existing solar panels on the market.*

#### ADVANTAGES:

- **Modularity:** eventuality to order the brush with the desired length, ad hoc for the panel.
- **Easy assembly:** also directly on the roof using simple screws.
- **Economic convenience.**
- **Simplicity of transport.**
- **Easy replacement.**

*SUNNY BRUSH is composed of:*

- *an aluminum core in modules of 1,000 mm.*
- *Brush D=200 mm in nylon in modules of 100 mm*
- *POM-C joint bushings with threaded inserts*
- *Locking collars and finishing of the ends*



## APPLICAZIONI / APPLICATIONS

Particolarmente indicato per il trattamento dei pannelli solari e fotovoltaici, ma può essere utilizzato anche per la pulizia di grandi lastre in plastica o vetro.

*Particularly suitable for the treatment of solar and photovoltaic panels, but it can also be used for cleaning large plastic or glass sheets.*

> Sunny Brush

## > Modularità e personalizzazione / Modularity and customization

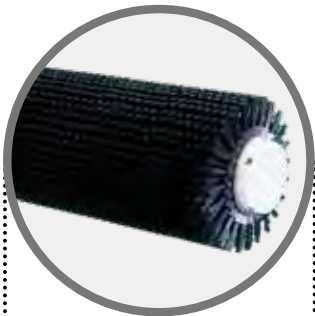

Modulo Intermedio  
*Intermediate Module*

Boccola di Giunzione  
*Junction Bushing*



Modulo Spazzola  
*Brush Module*

Collare Terminale  
*Terminal Collar*



Modulo Finale  
*Final Module*

Spazzole cilindriche punzonate modulari in filo in nylon nero liscio, ideale per pulizia di superfici delicate.  
*Cylindrical punched modular brushes in smooth black nylon wire, suitable for cleaning delicate surfaces.*

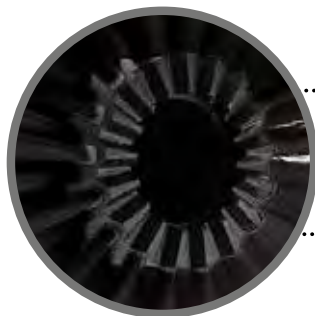

Le estremità dentate ai lati delle spazzole permettono di formare rulli di qualsiasi lunghezza.  
*The toothed ends on the sides of the brushes allow the formation of rollers of any length.*

I moduli sono autotrainanti grazie ai collari dentati terminali, dotati di 3 grani ciascuno, da porre all'estremità del rullo.  
*The modules are self-dragging thanks to the toothed end collars, equipped with 3 grains each, to be placed at the end of the roller.*

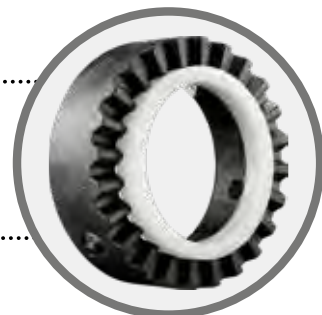

**8 m/s**  
MAXIMUM  
PERIPHERAL  
SPEED

Attenzione alla velocità di rotazione massima per l'applicazione di 8m/s (~ 800 RPM per spazzole Ø 200mm).  
*Pay attention to the maximum rotation speed for the application of 8m/s (~ 800 RPM for Ø 200mm brushes).*





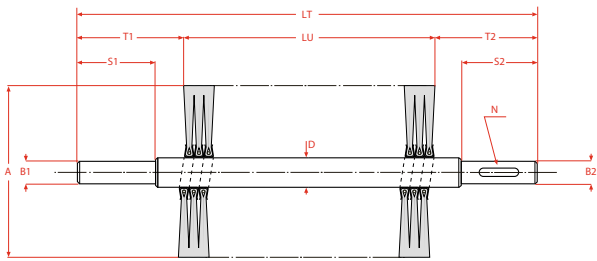

Spiral on shaft

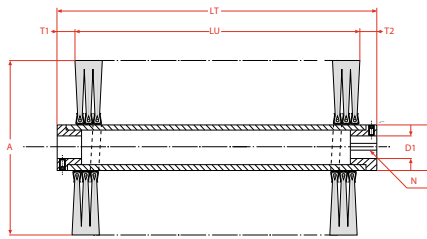

Spiral on tube

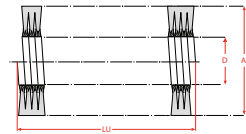

Free spiral

### MAXIMUM AND MINIMUM DIMENSION

		MIN		MAX	
		mm	inch	mm	inch
Outer diameter	<b>A</b>	40	1-5/8	1000	39-3/8
Inner diameter	<b>D</b>	12	1/2	500	20
Length	<b>LU</b>	5	3/16	4800	189
Pitch (density)	<b>P</b>	5	3/16	70	2-3/4

### ASSEMBLED BASES AND WINDING MINIMUM DIAMETER

BASE			MINIMUM DIAMETER			
mm	inch	STRIP TYPE	Steel		S-Steel	
			mm	inch	mm	inch
5	3/16	N	12	1/2	30	1-1/8
10	3/8	N	25	1	40	1-5/8
6	1/4	G	28	1-1/8	40	1-5/8
8	5/16	G	50	2	60	2-3/8

### Dimensions

- Overall length (LT) .....
- Useful length (LU) .....
- Outer diameter (A) .....
- Inner diameter (D) .....
- Hole diameter (D1) .....
- Keyway (N) .....
- Tube/shaft ends (T1/T2) .....
- Hubs length (S1/S2) .....
- Hubs diameter (B1/B2) .....
- Strip base (B) .....

### Strip type

- N = Normal
- G = Double band

### Trimming (if required)

- Normal trim
- Shaped trim
- Grinding
- Other: .....

### Final balancing (if required)

- Standard (ISO 1940 g6.3)
- Other: .....

### Shaft/tube material:

- Steel
- Stainless steel

### Tube/adaptor hole

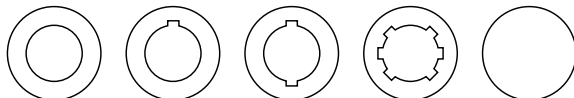

- Round
- 1 keyway
- 2 keyway
- Turtlebore
- Other .....

### Density (pitch)

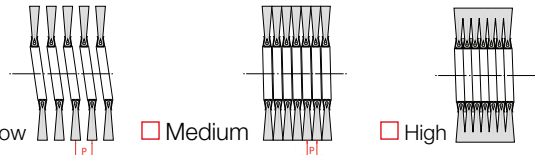

- Low
- Medium
- High

### Winding orientation

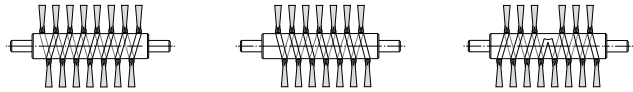

- Left
- Right (Standard)
- Convergent

### Fill material

- Carbon steel
- Stainless steel
- Brass
- Phosphorous Bronze
- Nylon - PA
- PP - PPL
- PVC
- Abrasive nylon (Silicon Carbide)
- Abrasive nylon (Aluminium Oxide)
- Horse hair
- Pig Bristle
- Tampico plant fiber
- Mixed .....
- Other .....

### Filament style

- Crimped
- Straight

### Filament diameter (and grit size) .....

### Filament colour .....

### Backing (and internal support) material

- Steel
- Stainless steel

### BRUSH OPERATING PARAMETERS

Application description .....

Operating temp. ....  °C  °F

### Working environment

- Dry
- Oil
- Water
- Base solution
- Acid solution
- Other .....

### Industry

- Mechanics/automation
- Primary metal/rolling mills
- Pipeline/oil & gas
- Chemical
- Food processing
- Agriculture
- Woodworking
- Tyre retreading
- Foundry
- Automotive
- Aerospace
- Sport
- Other .....

### BRUSH RFQ

Order/Sample quantity .....

Yearly potential .....

Item now being used (if competitor brush) .....

Price .....

NOTES/DRAWINGS

### CONTACT INFORMATIONS

Contact Name .....

Address .....

E-mail .....

Company .....

City .....

State .....

Phone .....

Zip .....



Società Italiana TecnoSpazzole

Via Porrettana 453,  
40033 Casalecchio di Reno (BO), Italy  
+39 0516113211  
info@sitbrush.com











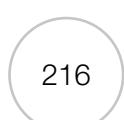
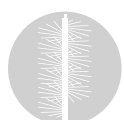

# SIT & SPORT

**Passione per le spazzole e l'attività all'aperto / Passion for brushes and outdoor activity**

Grazie alle sue applicazioni innovative, SIT fornisce tecnologia e prodotti anche al mondo dello sport. Passione, esperienza ed intuito hanno condotto Pietro Acquaderni all'invenzione della pista da sci sintetica "QUATTROSTAGIONI", brevettata nel 1962, che ha reso la SIT primo produttore al mondo di piste artificiali per lo sci. Il prodotto SIT riproduce efficacemente le caratteristiche del manto nevoso per lo sci alpino, lo sci nordico e il salto con gli sci. SIT offre inoltre una vasta gamma di soluzioni per golf, calcio, tennis e campi sportivi di ogni genere.

*Thanks to its innovative nature and its passion, SIT has patented technologies and products in sports industry (ski but also golf and tennis). In 1962 Pietro Acquaderni, starting from his passion for winter sports, created and patented artificial ski slopes "QUATTROSTAGIONI", that reproduce the attributes of snow, for downhill, ski jumping and cross-country skiing. Experience and intuitions lead to many patents and soon SIT became first inventor and manufacturer worldwide for brush ski slopes.*

## SALTO CON GLI SCI / SKI-JUMP



Sistema a "sandwich" brevettato da SIT e certificato alla FIS (Fédération Internationale de Ski) e composto da:

*Patented SIT "sandwich" system certified to FIS (International Ski Federation) made of:*

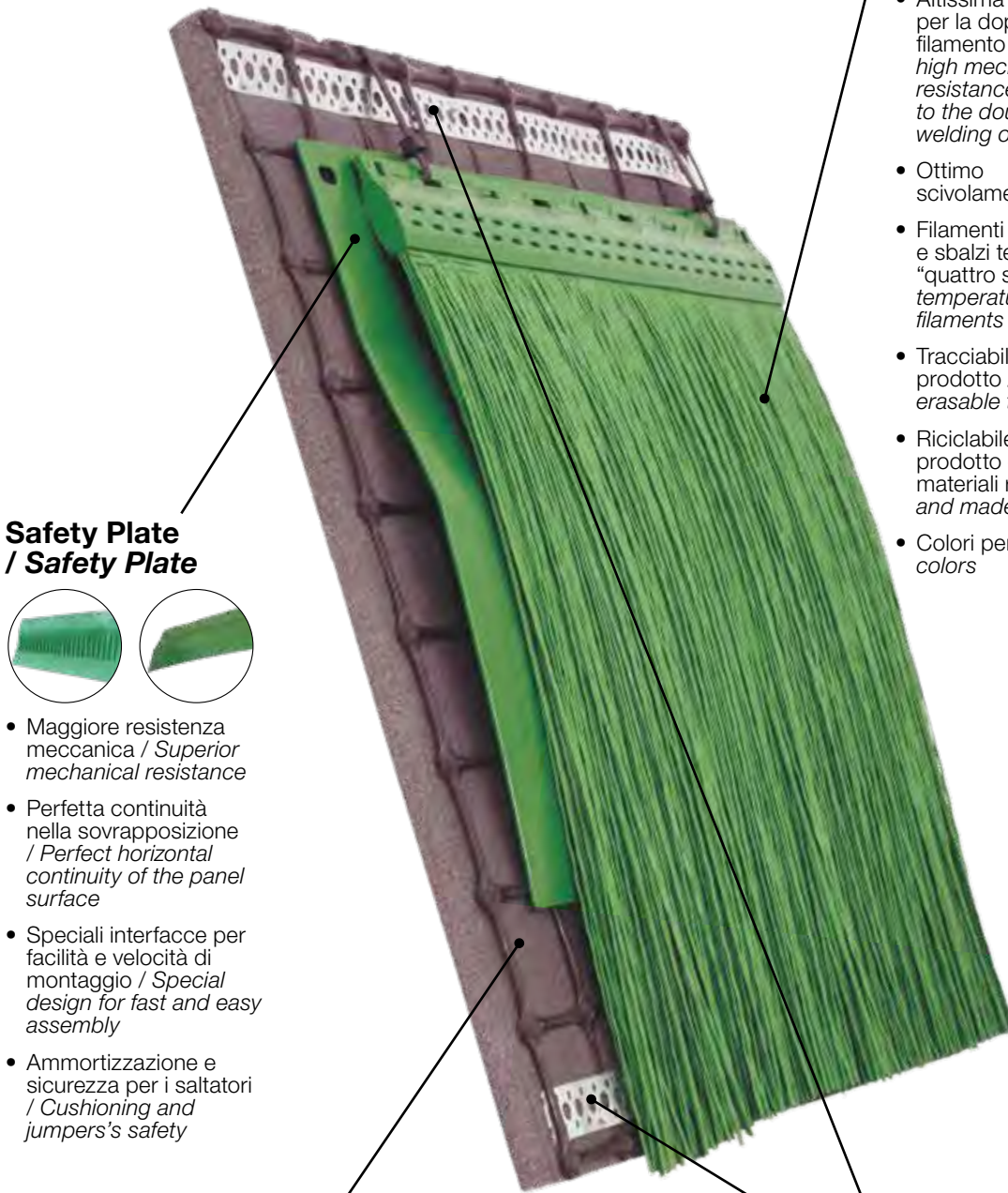

**Safety Plate / Safety Plate**

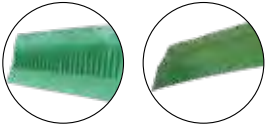

- Maggiore resistenza meccanica / *Superior mechanical resistance*
- Perfetta continuità nella sovrapposizione / *Perfect horizontal continuity of the panel surface*
- Speciali interfacce per facilità e velocità di montaggio / *Special design for fast and easy assembly*
- Ammortizzazione e sicurezza per i saltatori / *Cushioning and jumpers's safety*

**Rete e materassino / Net and Mat**

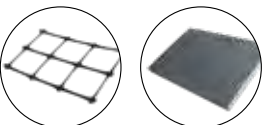

- Polietilene ad alta densità / *High density polyethylene*
- Resistenza a stress e sollecitazioni / *High stress resistance*

**Pannello a spazzola / Brush Panel**

- Altissima resistenza meccanica per la doppia saldatura del filamento / *Very high mechanical resistance thanks to the double welding of filament*
- Ottimo scivolamento / *High sliding*
- Filamenti resistenti a raggi UV e sbalzi termici per un uso "quattro stagioni" / *UV rays and temperature variations resistant filaments for a "4 seasons" use*
- Tracciabilità del prodotto / *Non erasable traceability*
- Riciclabile e prodotto con materiali riciclati / *Recyclable and made of recycled materials*
- Colori personalizzabili / *Custom colors*

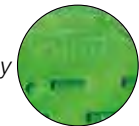

**Nastro zincato e fascette / Zinc plated belt and nylon strip**



- Additivi speciali per resistenza a raggi UV, bagnato ed a sbalzi termici / *Special additives for UV rays, wet and temperature variations resistance*



SCI DA DISCESA / DOWNHILL SKI



SCI DA FONDO / CROSS COUNTRY SKI



GUARDA IL VIDEO  
WATCH THE VIDEO  
[sitbrush.tv/ski1](http://sitbrush.tv/ski1)

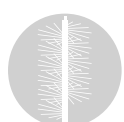



GOLF, TENNIS, CALCIO, ... / GOLF, TENNIS, SOCCER, ...

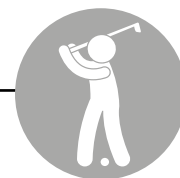

Multibruco / Brush Bug



Sistema con spazzola in filo sintetico per eliminare sabbia, fango, erba, neve dai piedi o dalla scarpe. Semplice da montare e con colori personalizzabili!

System fitted with a synthetic filament brush for sand, grass, mud, snow removal from shoes or bare feet. Easy to install and fully customizable with your colours!

Pulisci scarpe sportive e da lavoro / Sport and work shoe cleaner



Dotata di spazzola rotante motorizzata è ideale per la pulizia di scarpe da lavoro (all'interno o all'esterno di stabilimenti) e da sport (calcio, tennis, golf ...).

Provided with powered roller brush, this machine is ideal for work shoes (inside the plant or outdoor) and sport shoes (tennis, football, golf...).

**Vantaggi:** silenziosa, pratica, efficace, utilizzabile all'esterno, massima sicurezza garantita dal motore blindato e dall'impianto elettrico a 12V in scatola stagna, cassetto raccogli fango ampio e facilmente estraibile.

**Advantages:** quiet, handy, effective, can be used outdoor, maximum safety guaranteed by armoured motor and 12V electrical system in a waterproof box, mud collector (wide and easy to extract) included



SURF E ALTRO... / SURF & MORE...



Applicazioni nautiche: il pannello SIT brevettato completamente in plastica (PP/PPL) e trattato con speciali additivi anti-UV, è idoneo per coprire rampe per sci nautico, wakeboard, windsurf e kitesurf, oltre che per proteggere battigie, moli e scivoli acquatici. Modulari, facili da tagliare e da installare, i pannelli si adattano a qualsiasi superficie sopra e sotto l'acqua!

Marine applications: SIT patented panel, 100% PPL/PP and UV resistant, is suitable for covering ramps for water ski, wakeboard, windsurf and kite surf. It can be used for protecting shorelines, docks and water slides as well. Modular, easy to cut and easy to install, SIT panels are suitable for any surface above and underwater!





# REFERENZE / ITEMS

BARCODE EAN-13			
IT	SIT	EAN	
Ref 0063	80	06581	<b>000639</b>
Ref 0628	80	06581	<b>606282</b>

Gli articoli con ref rossa sono in pronta consegna / Items marked in RED are ready for immediate shipment

REF		Kg/pz	EAN	pag
0005	B/12/96	0,19	600051	92
0006	B/12/96	0,19	600068	92
0007	B/12/96	0,20	600075	92
0008	B/12/96	0,17	600082	92
0010	1/8	3,25	000103	92
0011	1/8	3,43	000110	92
0012	1/8	3,50	000127	92
0013	1/8	2,70	000134	92
0014	1/8	2,36	000141	92
0015	1/8	4,45	000158	93
0016	1/8	4,08	000165	93
0017	1/8	2,93	000172	92
0023	1/8	4,45	761158	93
0026	B/12/96	0,15	600266	95
0027	B/12/96	0,14	600273	95
0030	8	3,00	000301	93
0031	8	2,60	000318	93
0048	1/36	0,28	000486	70
0049	1/32	0,30	000493	70
0050	1/36	0,28	000509	70
0051	1/36	0,30	000516	70
0053	1/36	0,37	000530	70
0054	1/32	0,35	000547	70
0055	1/32	0,45	000554	70
0056	1/32	0,57	000561	70
0058	1/16	0,59	000585	70
0059	1/16	0,72	000592	70
0060	1/16	0,79	000608	70
0061	1/16	0,72	000615	70
0062	1/16	0,48	000622	71
0063	1/16	0,73	000639	70
0064	1/16	0,98	000646	70
0065	1/16	0,87	000653	70
0067	1/10	0,72	000677	70
0068	1/10	0,96	000684	70
0069	1/10	0,78	000691	70
0071	1/10	1,11	000714	70
0072	1/10	0,85	000721	70
0073	1/10	1,00	000738	70
0074	1/10	1,08	000745	70
0075	1/10	1,00	000752	70
0076	1/10	0,69	000769	71
0077	1/10	0,98	000776	70
0078	1/10	1,11	000783	70
0079	1/10	1,32	000790	70
0080	1/10	1,40	000806	70
0082	2	1,55	000820	70
0083	2	1,62	000837	70
0085	2	1,70	000851	70
0086	1	3,05	000868	73
0087	1	3,00	000875	73
0089	1	3,53	000899	73
0095	1	2,50	000950	73
0101	B/6/48	0,27	601010	75
0103	12/48	0,21	001032	32
0105	10/40	0,24	001056	32
0106	12/96	0,18	001063	36
0108	5/40	0,48	001087	32
0109	5/40	0,33	001094	32
0110	B/6/24	0,44	601102	32
0112	10/40	0,20	001124	36
0113	1/18	0,43	001131	31
0118	4/16	0,54	001186	32
0120	B/6/24	0,58	601201	32
0121	3/24	0,79	001216	32
0123	1/18	0,50	001230	31
0124	8/64	0,25	001247	32
0125	12/48	0,21	001254	30
0126	12/48	0,23	001261	30
0127	10/80	0,26	001278	30
0128	1/24	0,29	001285	30
0129	1/24	0,22	001292	30
0130	1/24	0,28	001308	30
0132	10/80	0,27	001322	30
0137	1/18	0,47	001377	31
0138	1/18	0,41	001384	31
0139	1/18	0,34	001391	31
0140	1/18	0,42	001407	31
0141	1/18	0,39	001414	31

REF		Kg/pz	EAN	pag
0146	1/24	0,19	001469	30
0147	1/16	0,75	001476	31
0148	1/16	0,74	001483	31
0149	1/16	0,82	001490	31
0150	1/16	0,81	001506	31
0151	1/16	0,59	001513	31
0152	1/16	0,69	001520	31
0154	1/24	0,28	001544	30
0158	1/16	1,00	001582	31
0159	1/16	1,07	001599	31
0160	1/16	0,93	001605	31
0164	2/64	0,22	001643	39
0165	2/64	0,27	001650	40
0166	10/40	0,56	001667	39
0167	10/40	0,52	001674	39
0169	2/64	0,25	001698	40
0170	12/96	0,17	001704	55
0171	1/36	0,23	001711	35
0172	1/36	0,23	001728	35
0173	12/96	0,21	001735	35
0174	2/64	0,20	001742	39
0175	1/32	0,41	001759	35
0176	1/16	0,50	001766	35
0177	2/32	0,97	001773	40
0178	1/36	0,25	001780	35
0182	1	1,03	001827	85
0200	B/12/96	0,10	602000	57
0202	B/12/96	0,17	602024	57
0205	B/12/96	0,16	602055	51
0209	B/12/96	0,05	602093	61
0210	B/12/96	0,09	602109	61
0211	B/6/48	0,20	602116	56
0212	B/6/48	0,20	602123	55
0214	B/6/48	0,15	602147	75
0215	B/6/48	0,17	602154	75
0216	B/12/96	0,12	602161	51
0217	B/6/48	0,16	602178	47
0218	B/12/96	0,08	602185	51
0219	B/6/48	0,33	602192	48
0220	B/12/96	0,04	602208	51
0222	B/6/48	0,27	602222	36
0227	B/6/48	0,23	602277	57
0228	B/6/48	0,24	602284	32
0240	12/48	0,28	002404	27
0241	1/24	0,28	002411	27
0242	12/48	0,28	002428	27
0245	1/24	0,32	002459	27
0252	1/18	0,72	002527	28
0253	1/18	0,74	002534	28
0254	1/18	0,69	002541	28
0259	1/18	0,80	002596	28
0260	1/18	0,83	002602	28
0261	1/18	0,85	002619	28
0268	1/9	1,08	002688	28
0269	1/9	1,00	002695	28
0270	1/9	1,05	002701	28
0271	1/9	1,00	002718	28
0276	1/9	1,30	002763	28
0277	1/8	1,26	002770	28
0278	1/8	1,26	002787	28
0279	1/8	1,20	002794	28
0280	1/12	0,26	700133	27
0284	1/8	1,65	002848	28
0298	1/8	0,66	002985	123
0300	12/96	0,13	003005	50
0301	B/6/48	0,17	603014	50
0302	12/96	0,16	003029	50
0303	12/96	0,14	003036	56
0304	B/6/48	0,17	603045	56
0305	12/96	0,19	003050	50
0306	B/6/48	0,18	603069	55
0307	12/96	0,15	003074	55
0308	1/36	0,26	003081	34
0309	12/48	0,24	003098	34
0310	12/96	0,14	003104	56
0312	1/36	0,27	003128	34
0315	1/32	0,48	003159	34
0316	1/16	0,74	003166	34
0317	1/8	0,99	003173	123
0318	12/96	0,13	003180	50
0319	1/8	1,32	003197	123
0320	B/6/24	0,53	603205	29
0321	1/8	0,60	003210	123
0322	B/6/18	0,93	603229	29
0323	1/24	0,50	003234	29
0325	12/48	0,25	003258	29
0326	12/48	0,28	003265	29
0328	6/24	0,58	003289	29

REF		Kg/pz	EAN	pag
0330	3/12	0,84	003302	29
0332	12/48	0,29	003326	29
0334	1/18	0,55	003340	28
0335	12/48	0,29	003357	29
0338	1/4	1,65	003388	66
0354	1/18	0,62	003548	28
0360	1/4	3,80	003609	42
0361	1/4	3,74	003616	42
0362	B/6/48	0,23	603625	104
0363	B/6/48	0,34	603632	104
0370	B/6/48	0,03	003708	104
0401	12/96	0,05	004019	52
0402	B/6/48	0,09	604028	52
0404	B/6/48	0,16	604042	82
0405	10	0,08	004057	82
0406	10	0,20	004064	82
0407	10	0,27	004071	82
0408	1	0,11	004088	82
0409	1	0,11	004095	82
0410	B/6/48	0,09	604103	53
0411	B/6/48	0,17	604110	53
0416	25/100	0,04	004163	53
0417	25/100	0,03	004170	53
0418	10/80	0,10	004187	53
0419	10/80	0,11	004194	53
0420	10/80	0,20	004200	53
0421	10/80	0,17	004217	53
0422	10	0,22	004224	82
0423	10	0,21	004231	82
0424	3	0,49	004248	82
0425	3	0,38	004255	82
0428	3	0,77	004286	82
0429	3	0,56	004293	82
0433	5/40	0,04	004330	128
0435	10/80	0,05	004354	53
0436	10/80	0,13	004361	53
0442	10/80	0,04	004422	128
0443	10/40	0,09	004439	128
0448	10/120	0,07	004484	128
0449	12/144	0,10	004491	128
0450	B/12/96	0,05	604509	112
0454	10/80	0,10	004545	126
0455	10/80	0,09	004552	126
0456	10/80	0,08	004569	126
0466	10/80	0,08	004668	126
0467	10/80	0,08	004675	126
0468	10/80	0,07	004682	126
0470	10/80	0,02	004705	53
0472	10/80	0,05	004729	53
0473	10/80	0,05	004736	53
0474	10/80	0,05	004743	53
0475	10/80	0,07	004750	53
0476	10/80	0,06	004767	53
0477	10/80	0,07	004774	53
0478	10/80	0,08	004781	53
0479	10/80	0,09	004798	53
0480	10/80	0,08	004804	53
0486	10/80	0,11	004866	126
0487	10/80	0,11	004873	126
0488	10/80	0,09	004880	126
0490	10/80	0,09	004903	126
0492	10/80	0,07	004927	126
0493	10/80	0,11	004934	126
0494	10/80	0,11	004941	126
0495	10/80	0,10	004958	126
0496	10/80	0,09	004965	126
0497	10/80	0,1		

REF		Kg/pz	EAN	pag
0522	5	1,01	005221	38
0524	1/10	1,70	005245	76
0525	1/10	1,70	005252	76
0526	1/9	2,33	005269	76
0527	1/9	2,22	005276	76
0528	1	1,61	005283	76
0530	1	2,65	005306	76
0531	1	2,75	005313	76
0532	1	3,70	005320	76
0533	1	3,60	005337	76
0534	10/40	0,31	005344	39
0535	10/40	0,31	005351	39
0536	12/48	0,25	005368	39
0539	12/96	0,18	005399	38
0540	12/96	0,18	005405	38
0541	12/48	0,25	005412	39
0542	12/48	0,24	005429	39
0543	12/48	0,25	005436	39
0544	12/48	0,23	005443	39
0545	10/40	0,31	005450	39
0546	10/40	0,25	005467	39
0547	10/40	0,31	005474	39
0548	10/40	0,26	005481	39
0549	10/40	0,43	005498	39
0550	10/40	0,40	005504	39
0551	6/24	0,75	005511	38
0553	12/48	0,36	005535	39
0556	10/40	0,37	005566	38
0560	12/96	0,18	005603	39
0561	12/96	0,18	005610	39
0562	12/96	0,18	005627	39
0563	12/96	0,18	005634	39
0564	6/24	0,55	005641	38
0565	6/24	0,54	005658	38
0567	B/8	0,60	005672	141
0568	1	1,90	761189	76
0570	1	0,23	005702	131
0571	1	0,23	005719	131
0572	1	0,48	005726	131
0573	1	0,48	005733	131
0574	1	0,24	005740	131
0575	1	0,24	005757	131
0576	1	0,58	005764	131
0577	1	0,58	005771	131
0578	1	0,36	005788	131
0579	1	0,73	005795	131
0580	1	1,03	005801	131
0581	1	0,10	005818	131
0582	1	0,10	005825	131
0583	1	0,10	005832	131
0584	1	0,25	005849	131
0585	1	0,25	005856	131
0586	1	0,25	005863	131
0587	1	0,12	005870	131
0588	1	0,76	005887	131
0589	1	0,76	005894	131
0590	1	0,10	005900	131
0591	1	0,96	005917	131
0592	1	0,96	005924	131
0593	1	0,33	005931	72
0594	1	0,07	005948	72
0595	1	0,07	005955	72
0596	1	0,33	005962	72
0597	1	0,33	005979	72
0609	24/192	0,07	006099	52
0610	B/6/48	0,11	606107	52
0611	14/112	0,10	006112	52
0612	B/6/48	0,14	606121	52
0613	24/192	0,05	006136	57
0614	B/6/48	0,09	606145	57
0615	15/120	0,10	006150	57
0616	B/6/48	0,15	606169	57
0617	20/160	0,04	006174	61
0618	B/6/48	0,06	606183	61
0619	24/192	0,07	006198	52
0620	B/6/48	0,11	606206	52
0621	14/112	0,10	006211	52
0622	B/6/48	0,13	606220	52
0623	24/192	0,05	006235	57
0624	B/6/48	0,09	606244	57
0625	15/120	0,10	006259	57
0626	B/6/48	0,14	606268	57
0627	20/160	0,04	006273	61
0628	B/6/48	0,06	606282	61
0645	1/8	1,16	006457	66
0650	12/96	0,10	006501	56
0652	12/96	0,11	006525	56
0653	12/96	0,08	006532	56
0654	12/96	0,13	006549	56
0655	12/96	0,17	006556	56

REF		Kg/pz	EAN	pag
0656	12/96	0,15	006563	56
0657	12/96	0,17	006570	56
0660	30/240	0,07	006600	57
0661	12/96	0,13	006617	57
0690	4/36	0,08	006907	74
0691	4/24	0,06	006914	74
0692	1/24	0,09	006921	74
0693	4/12	0,11	006938	74
0703	5/40	0,10	007034	75
0704	5/40	0,28	007041	75
0705	B/6/48	0,38	607050	75
0708	5/40	0,11	007089	75
0709	5/40	0,32	007096	75
0710	B/6/48	0,37	607104	75
0713	5/20	0,33	007133	75
0714	5/20	0,52	007140	75
0715	B/6/48	0,59	607159	75
0716	4/16	0,64	007164	75
0719	4/16	0,72	007195	75
0721	2	1,00	007218	75
0722	2	0,72	007225	75
0723	2	0,90	007232	75
0724	1	0,79	007249	75
0725	B/6/48	0,27	607258	32
0730	B/6/48	0,32	607302	27
0731	B/6/48	0,29	607319	27
0740	B/6/48	0,30	607401	29
0745	B/6/48	0,22	607456	36
0746	B/6/48	0,23	607463	36
0760	B/6/48	0,25	607609	34
0761	B/6/48	0,28	607616	34
0768	6/48	0,18	007683	46
0771	1/6	0,56	007713	86
0772	1/6	0,54	007720	86
0773	1/6	0,53	007737	86
0775	1/6	1,27	007751	86
0776	1/6	1,00	007768	86
0777	1/6	1,00	007775	86
0778	1	0,24	007782	88
0779	1	0,34	007799	88
0781	1/6	1,30	007812	86
0782	1/6	0,48	007829	88
0783	1/6	0,45	007836	88
0784	1/6	0,45	007843	88
0786	1/6	1,02	007867	86
0787	1/6	0,53	007874	88
0789	12/96	0,10	007898	50
0790	12/96	0,04	007904	50
0791	12/96	0,05	007911	50
0792	12/96	0,06	007928	50
0793	12/96	0,08	007935	60
0794	48/384	0,03	007942	61
0795	48/192	0,07	007959	61
0796	48/192	0,07	007966	61
0797	12/96	0,07	007973	60
0798	1	0,22	007980	88
0800	12/96	0,01	008000	59
0801	12/96	0,02	008017	59
0802	12/96	0,02	008024	59
0803	12/96	0,02	008031	63
0804	12/96	0,02	008048	59
0805	12/96	0,02	008055	59
0806	12/96	0,03	008062	59
0807	12/96	0,04	008079	59
0808	12/96	0,02	008086	63
0810	12/96	0,05	008109	59
0811	12/96	0,04	008116	59
0812	12/96	0,04	008123	59
0813	12/96	0,06	008130	59
0814	12/96	0,06	008147	59
0815	12/96	0,05	008154	63
0816	12/96	0,05	008161	63
0817	12/96	0,07	008178	59
0818	12/96	0,06	008185	59
0819	12/96	0,06	008192	59
0820	12/96	0,08	008208	59
0821	12/96	0,07	008215	59
0822	12/96	0,10	008222	59
0823	12/96	0,10	008239	59
0824	12/96	0,07	008246	60
0825	12/96	0,05	008253	59
0826	12/96	0,07	008260	59
0827	12	0,12	008277	62
0828	24	0,05	008284	62
0829	24/288	0,05	008291	62-80
0830	12/96	0,03	008307	63
0831	12/96	0,04	008314	62
0832	12/96	0,06	008321	62
0833	12/96	0,10	008338	62
0834	12/96	0,04	008345	62

REF		Kg/pz	EAN	pag
0835	12/96	0,04	008352	62
0836	12/96	0,05	008369	62
0837	12/96	0,05	008376	64
0838	12/96	0,03	008383	63
0839	12/96	0,07	008390	64
0840	12/96	0,07	008406	64
0841	12/96	0,08	008413	64
0842	12/96	0,04	008420	63
0843	12/19	0,07	008437	59
0844	12/96	0,11	008444	64
0845	12/96	0,11	008451	64
0846	12/96	0,12	008468	64
0847	12/19	0,09	008475	59
0848	12/96	0,05	008482	47
0850	12/96	0,06	008505	47
0851	12/96	0,08	008512	47
0852	12/96	0,04	008529	63
0853	12/96	0,09	008536	47
0854	12/96	0,11	008543	48
0855	12/96	0,08	008550	47
0856	12/96	0,07	008567	47
0857	12/96	0,10	008574	47
0858	36/144	0,12	008581	47
0859	12/96	0,12	008598	47
0860	36/144	0,14	008604	47
0861	12/96	0,13	008611	47
0862	12/96	0,08	008628	47
0863	12/96	0,11	008635	47
0864	12/96	0,07	008642	48
0865	12/96	0,13	008659	47
0866	10/40	0,26	008666	48
0867	12/96	0,08	008673	47
0868	12/96	0,08	008680	47
0869	12/96	0,12	008697	47
0870	1/24	0,30	008703	49
0871	12/96	0,15	008710	47
0872	12/96	0,02	008727	63
0873	12/96	0,11	008734	48
0874	12/96	0,15	008741	48
0875	12/96	0,17	008758	48
0876	12/96	0,15	008765	48
0877	12/96	0,16	008772	48
0878	1/24	0,40	008789	49
0879	12/96	0,18	008796	48
0880	B/6/48	0,23	608804	46
0881	12/96	0,18	008819	48
0882	10/40	0,28	008826	48
0883	B/6/48	0,21	008833	46
0884	2/24	0,29	008840	49
0885	48/384	0,03	008857	51
0886	48/384	0,04	008864	51
0887	36/288	0,05	008871	51
0888	24/192	0,06	008888	51
0889	24/192	0,08	008895	51
0890	12/96	0,12	008901	51
0891	B/6/48	0,23	008918	46
0892	12/96	0,02	008925	63
0893	B/6/48	0,16	008932	46
0894	1/24	0,46	008949	49
0895	1/8	2,8		

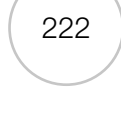



REF		Kg/pz	EAN	pag
0936	1/24	0,30	009366	27
0937	1/18	0,85	009373	28
0938	1/9	1,05	009380	28
0939	1/8	1,29	009397	28
0940	B/6/48	0,20	609405	55
0941	12/96	0,17	009410	55
0942	B/6/48	0,28	609429	30
0943	B/6/48	0,28	609436	27
0945	B/6/48	0,23	609450	35
0946	1/36	0,22	009465	35
0948	1/36	0,27	009489	34
0949	B/6/48	0,27	609498	34
0950	B/6/48	0,25	609504	34
0951	1/36	0,23	009519	34
0952	12/96	0,04	009526	63
0953	12/96	0,02	009533	59
0954	12/96	0,02	009540	59
0955	B/6/48	0,04	609559	59
0956	12/96	0,03	009564	59
0957	12/96	0,04	009571	59
0958	1/36	0,21	009588	35
0959	12/96	0,05	009595	64
0960	B/6/48	0,07	609603	61
0961	12/96	0,06	009618	59
0962	12/96	0,06	009625	59
0963	12/96	0,07	009632	64
0964	12/96	0,07	009649	64
0965	B/6/48	0,09	609658	51
0966	12/96	0,08	009663	47
0967	12/96	0,09	009670	47
0968	12/96	0,10	009687	47
0969	12/96	0,12	009694	47
0970	B/6/48	0,11	609702	51
0971	12/96	0,11	009717	47
0972	12/96	0,12	009724	47
0973	12/96	0,12	009731	47
0974	12/96	0,15	009748	47
0975	B/6/48	0,14	609757	51
0976	12/96	0,15	009762	48
0977	12/96	0,17	009779	48
0978	12/96	0,17	009786	51
0979	12/96	0,17	009793	48
0980	B/6/48	0,12	609801	57
0981	12/96	0,09	009816	59
0982	12/96	0,11	009823	64
0983	12/96	0,11	009830	64
0984	12/96	0,11	009847	56
0985	B/6/48	0,15	609856	57
0986	12/96	0,16	009861	56
0987	12/96	0,13	009878	56
0988	12/96	0,13	009885	56
0990	B/6/48	0,34	609900	104
0993	12/19	0,07	009939	59
0994	2/24	0,23	009946	49
0996	1/16	0,67	009960	70
0997	1/10	0,95	009977	70
0998	12/19	0,09	009984	59
0999	12/96	0,12	009991	47
1013	2	0,03	010133	77
1014	2	0,02	010140	77
1015	2	0,02	010157	77
1017	2	0,02	010171	77
1018	2	0,01	010188	77
1019	2	0,01	010195	77
1020	2	0,01	010201	77
1021	2	0,01	010218	77
1022	2	0,01	010225	77
1023	2	0,01	010232	77
1024	2	0,02	010249	77
1025	2	0,01	010256	77
1026	2	0,02	010263	77
1028	2	0,05	010287	77
1029	2	0,05	010294	77
1030	2	0,07	010300	77
1031	2	0,07	010317	77
1032	2	0,07	010324	77
1033	2	0,02	010331	77
1034	2	0,07	010348	77
1035	2	0,10	010355	77
1036	2	0,10	010362	77
1037	2	0,10	010379	77
1038	2	0,01	010386	77
1039	2	0,01	010393	77
1040	2	0,01	010409	77
1041	2	0,01	010416	77
1042	2	0,01	010423	77
1043	2	0,01	010430	77
1046	2	0,10	010461	77
1047	2	0,10	010478	77
1048	2	0,10	010485	77

REF		Kg/pz	EAN	pag
1049	2	0,10	010492	77
1050	2	0,10	010508	77
1051	2	0,10	010515	77
1052	2	0,10	010522	77
1053	2	0,01	010539	77
1054	2	0,01	010546	77
1055	2	0,01	010553	77
1056	2	0,01	010560	77
1057	2	0,10	010577	77
1058	2	0,10	010584	77
1059	1	0,05	010591	77
1060	2	0,01	010607	77
1062	1	0,03	010621	11
1070	2	0,10	010706	77
1077	1	0,05	010775	129
1078	1	0,10	010782	129
1080	1	0,24	010805	129
1081	1	0,25	010812	129
1083	1	0,31	010836	129
1084	1	0,35	010843	129
1085	1	0,35	010850	129
1086	1	0,34	010867	129
1087	1	0,55	010874	129
1088	1	0,57	010881	129
1089	1	0,57	010898	129
1090	1	0,58	010904	129
1091	1	0,58	010911	129
1092	1	0,70	010928	129
1093	1	0,64	010935	129
1094	1	0,64	010942	129
1095	1	0,64	010959	129
1300	10	0,01	013004	100
1301	10	0,01	013011	100
1302	10	0,01	013028	100
1303	10	0,01	013035	100
1304	10	0,01	013042	100
1305	10	0,01	013059	100
1306	10	0,01	013066	100
1307	10	0,01	013073	100
1308	10	0,01	013080	100
1309	10	0,01	013097	100
1310	10	0,01	013103	100
1311	10	0,01	013110	100
1312	10	0,01	013127	100
1313	10	0,02	013134	100
1314	10	0,02	013141	100
1315	10	0,02	013158	100
1316	10	0,02	013165	100
1317	10	0,02	013172	100
1318	10	0,02	013189	100
1319	10	0,02	013196	100
1320	10	0,03	013202	100
1321	10	0,03	013219	100
1322	10	0,03	013226	100
1323	10	0,03	013233	100
1324	10	0,03	013240	100
1325	10	0,03	013257	100
1326	10	0,03	013264	100
1334	10	0,01	013349	100
1337	10	0,01	013370	100
1340	10	0,01	013400	101
1341	10	0,02	013417	101
1342	10	0,02	013424	101
1343	10	0,02	013431	101
1344	10	0,02	013448	101
1345	10	0,02	013455	101
1346	10	0,06	013462	101
1347	10	0,09	013479	101
1348	10	0,10	013486	101
1349	10	0,11	013493	101
1350	10	0,13	013509	101
1359	1/6	0,72	013592	88
1360	1/6	0,74	013608	88
1361	1/6	1,16	013615	88
1362	1/6	1,10	013622	88
1363	1/6	1,19	013639	88
1368	1/6	0,79	013684	88
1369	1/6	0,56	013691	88
1370	1/6	0,55	013707	88
1371	1/6	0,83	013714	88
1372	1/6	0,86	013721	88
1373	1	0,01	013738	88
1374	1/6	0,43	013745	88
1375	1/6	0,45	013752	88
1376	1/6	0,45	013769	88
1377	1/6	0,47	013776	88
1386	1	1,50	013868	87
1387	1	1,92	013875	87
1388	1/6	0,75	013882	88
1389	1/6	0,74	013899	88

REF		Kg/pz	EAN	pag
1400	10/120	0,02	014001	80
1401	10/120	0,03	014018	80
1402	10/120	0,03	014025	80
1403	10/80	0,04	014032	80
1404	10/80	0,05	014049	80
1405	1	0,03	014056	81
1406	10/80	0,07	014063	80
1407	10/40	0,08	014070	80
1408	10/80	0,07	014087	80
1409	10/80	0,06	014094	80
1410	10/80	0,10	014100	80
1412	10/40	0,11	014124	80
1413	10/40	0,12	014131	80
1414	10/40	0,58	014148	80
1415	10	0,13	014155	80
1416	10	0,13	014162	80
1418	10	0,14	014186	80
1419	10	0,08	014193	80
1420	10	0,01	014209	80
1421	10	0,08	014216	80
1422	10	0,16	014223	80
1423	10	0,17	014230	80
1424	10	0,15	014247	80
1426	5	0,19	014261	81
1430	5	0,17	014308	81
1431	1	0,10	014315	81
1433	5	0,25	014339	81
1434	5	0,25	014346	81
1437	5	0,25	014377	81
1438	1	0,12	014384	81
1439	1	0,14	014391	81
1440	1	0,50	014407	81
1441	1	0,34	014414	81
1442	1	0,34	014421	81
1445	1	0,34	014452	81
1446	1	0,34	014469	81
1447	1	0,58	014476	81
1448	1	0,93	014483	81
1449	1	0,55	014490	81
1450	1	0,55	014506	81
1453	1	0,55	014537	81
1454	1	0,55	014544	81
1455	1	0,55	014551	81
1456	1	0,60	014568	81
1461	1	0,19	014612	81
1462	1	0,30	014629	81
1466	5	0,27	014667	81
1467	5	0,28	014674	81
1468	5	0,27	014681	81
1519	1	0,14	015190	81
1521	1	0,14	015213	81
1522	1	0,14	015220	81
1542	1	0,19	015428	81
1743	10/80	0,03	017439	127
1744	10/80	0,15	017446	127
1745	10/80	0,06	017453	127
1746	10/80	0,10	017460	127
1747	10/80	0,04	017477	127
1749	10/80			

REF		Kg/pz	EAN	pag
1822	24	0,02	018221	95
1823	12	0,12	018238	94
1824	1	0,78	018245	124
1831	1	0,73	018313	124
1832	1	1,10	018320	124
1833	12	0,65	018337	124
1837	1	1,08	018375	124
1839	12	0,80	018399	124
1840	12	0,10	018405	94
1841	9	0,38	018412	125
1842	12	0,31	018429	106
1844	5	0,41	018443	125
1845	6	0,50	018450	109
1847	6	0,64	018474	106
1848	5	0,34	018481	108
1849	18	0,30	018498	106
1850	24	0,20	018504	106
1852	18	0,33	018528	106
1854	12	0,38	018542	106
1856	12	0,44	018566	106
1858	8	0,50	018580	106
1859	8	0,68	018597	106
1860	12	0,21	018603	107
1861	12	0,23	018610	107
1862	18	0,41	018627	106
1864	12	0,46	018641	106
1866	8	0,56	018665	106
1868	12	0,42	018689	106
1870	8	0,62	018702	106
1872	25	0,16	018726	108
1873	25	0,21	018733	108
1874	25	0,24	018740	108
1875	5	0,28	018757	108
1876	1/25	0,28	018764	108
1877	12	0,15	018771	94
1878	12	1,30	018788	105
1880	1	0,90	018801	108
1881	12	1,70	018818	105
1882	5	0,21	018825	108
1883	8	0,66	018832	106
1885	6	0,72	018856	106
1886	8	0,58	018863	106
1887	8	0,68	018870	106
1891	24	0,17	018917	106
1892	18	0,18	018924	107
1893	24	0,15	018931	107
1894	18	0,17	018948	107
1895	6	0,33	018955	109
1897	6	0,39	018979	109
1899	24	0,13	018993	107
1900	12	0,07	019006	104
1901	12	0,08	019013	104
1902	12	0,10	019020	104
1903	12	0,11	019037	104
1904	12	0,11	019044	104
1905	12	0,12	019051	104
1906	12	0,12	019068	104
1907	12	0,12	019075	104
1908	12	0,13	019082	104
1909	12	0,14	019099	104
1910	12	0,15	019105	104
1911	12	0,16	019112	104
1912	12	0,18	019129	104-110
1913	12	0,17	019136	104
1914	12	0,18	019143	104
1916	12	0,19	019167	104
1917	12	0,19	019174	104
1918	12	0,22	019181	104
1919	6	0,25	019198	104
1920	1	0,52	019204	104
1921	1	0,74	019211	104
1922	1	0,40	019228	104
1924	10/80	0,06	019242	102
1925	10/80	0,06	019259	102
1926	10/80	0,06	019266	102
1927	12	0,09	019273	102
1928	12	0,10	019280	102
1929	12	0,07	019297	102
1930	12	0,09	019303	102
1931	12	0,07	019310	102
1932	25	0,03	019327	112
1933	12	0,06	019334	112
1934	6	0,51	019341	109
1935	25	0,15	019358	108
1936	1/12	0,04	019365	108-110
1938	12	0,10	019389	112
1940	6	0,20	019402	104
1941	6	0,29	019419	104
1942	6	0,31	019426	104
1943	6	0,34	019433	104

REF		Kg/pz	EAN	pag
1944	6	0,40	019440	104
1945	6	0,43	019457	104
1948	12	1,30	019488	105
1949	1	0,65	019495	109
1950	12	0,05	019501	104
1951	12	0,09	019518	104
1952	12	0,09	019525	104
1953	12	0,10	019532	104
1954	12	0,10	019549	104
1955	12	0,10	019556	104
1956	12	0,11	019563	104
1957	12	0,13	019570	104
1958	12	0,12	019587	104
1959	12	0,13	019594	104
1960	12	0,13	019600	104
1961	12	0,13	019617	104
1962	12	0,13	019624	104-110
1963	12	0,14	019631	104
1964	12	0,14	019648	104
1966	12	0,14	019662	104
1967	12	0,16	019679	104
1968	12	0,17	019686	104
1969	6	0,17	019693	104
1972	12	0,10	019723	94
1973	12	0,32	019730	109
1974	1/6	0,50	019747	125
1975	1/4	0,50	019754	125
1976	12/120	0,80	019761	104
1977	12	0,09	019778	104
1978	6/72	0,10	019785	110
1979	12	0,08	019792	104
1981	12	0,09	019815	104
1982	12	0,36	019822	109
1983	12	0,14	019839	104
1985	12/120	0,80	019853	104
1986	12/120	0,80	019860	104
1987	12	0,11	019877	104-110
1988	6/72	0,24	019884	110
1989	12/120	0,80	019891	104
1990	12/120	0,80	019907	104
1991	12	0,12	019914	104
1992	12	0,13	019921	104
1993	1	0,18	019938	110
1994	12/120	0,80	019945	104
1995	1/12	0,15	019952	110
1997	1	0,04	019976	110
1998	1	0,23	019983	110
1999	6/72	0,02	019990	80-110
2000	6/48	0,02	020002	80-110
2001	6/48	0,02	020019	80-110
2006	6/24	0,09	020064	110
2012	12/48	0,31	020125	38
2013	12/48	0,32	020132	38
2060	12/96	0,18	020606	38
2061	12/96	0,18	020613	38
2096	10/40	0,33	020965	38
2097	10/40	0,36	020972	38
2099	10/40	0,36	020996	38
2108	10/40	0,43	021085	39
2109	10/40	0,40	021092	39
2153	5	2,40	021535	76
2171	6/24	0,54	021719	38
2172	6/24	0,59	021726	38
2198	1	2,65	021986	76
2199	1	2,65	021993	76
2333	1/18	0,75	023331	28
2397	1	2,62	023973	28
2429	1/32	0,40	024291	35
2430	1/32	0,42	024307	35
2433	1/16	0,48	024338	35
2463	1/32	0,79	024635	34
2464	1/16	0,73	024642	34
2465	1/32	0,48	024659	34
2466	1/32	0,35	024666	40
2467	1/32	0,35	024673	40
2468	1/32	0,31	024680	40
2469	1/32	0,33	024697	40
2470	6/24	0,42	024703	40
2471	6/24	0,48	024710	40
2475	6/24	0,50	024758	40
2476	6/24	0,54	024765	40
2480	6/24	0,44	024802	40
2481	6/24	0,42	024819	40
2485	6/24	0,50	024857	40
2486	6/24	0,58	024864	40
2489	10	0,02	024895	64
2490	10	0,08	024901	64
2493	10	0,01	024932	59
2495	12/96	0,07	024956	59
2496	12/96	0,06	024963	60

REF		Kg/pz	EAN	pag
2501	6/24	0,35	025014	71
2502	12/96	0,06	025021	47
2503	6/24	0,33	025038	71
2504	12/96	0,05	025045	51
2505	12/96	0,06	025052	47
2506	12/96	0,06	025069	48
2508	12/96	0,08	025083	47
2509	6/24	0,32	025090	71
2510	12/96	0,09	025106	47
2512	12/96	0,06	025120	51
2513	12/96	0,11	025137	48
2514	12/96	0,06	025144	51
2516	12/96	0,06	025168	51
2518	12/96	0,07	025182	51
2520	12/96	0,09	025205	51
2522	12/96	0,07	025229	57
2526	12/96	0,09	025267	57
2528	12/96	0,06	025281	61
2543	12/48	0,21	025434	30
2549	1/24	0,29	025496	30
2551	1/24	0,26	025519	30
2555	1/18	0,48	025557	31
2556	1/18	0,48	025564	31
2560	1/32	0,38	025601	35
2562	1/36	0,22	025625	34
2563	1/32	0,47	025632	34
2567	12/48	0,25	025670	29
2574	1/24	0,30	025748	27
2581	12/96	0,18	025816	38
2585	6/24	0,58	025854	38
2587	12/48	0,26	025878	39
2591	12/48	0,30	025915	27
2595	1/18	0,84	025953	28
2596	1/18	0,85	025960	28
2602	1/8	1,26	026028	28
2606	1/16	0,76	026066	31
2607	1/16	0,72	026073	31
2614	10/40	0,31	026141	39
2801	10	0,01	028015	102
2802	10	0,01	028022	102
2803	10	0,01	028039	102
2804	10	0,01	028046	102
2805	10	0,02	028053	102
2806	10	0,02	028060	102
2807	10	0,02	028077	102
2808	10	0,02	028084	102
2809	10	0,04	028091	102
2810	10	0,01	028107	102
2811	10	0,01	028114	102
2812	10	0,01	028121	102
2813	10	0,01	028138	102
2814	10	0,02	028145	102
2815	10	0,02	028152	102
2816	10	0,02	028169	102
2817	10	0,02	028176	102
2818	10	0,04	028183	102
2819	10	0,01	028190	102
2820	10	0,01	028206	102
2821	10	0,01	028213	102
2822	10	0,01	028220	102
2823	10	0,02	028237	102
2824	10	0,02	028244	102
2825	10	0,02	028251	102

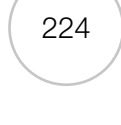
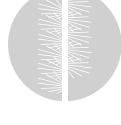

2854	6	0,04	028541	100
2855	6	0,05	028558	100
2905	1	0,58	029050	129
2906	1	0,58	029067	129
2907	1	0,58	029074	129
2930	1	0,05	029302	129
3145	12/96	0,01	031459	47
3146	12/96	0,02	031466	47
3151	36/144	0,07	031510	47
3155	2/12	0,33	031558	49
3240	1	0,35	032401	89
3241	1	0,35	032418	89
3242	1	0,35	032425	89
3243	1	0,38	032432	89
3244	1	0,64	032449	89
3245	1	0,64	032456	89
3246	1	0,65	032463	89
3247	1	0,64	032470	89
3260	1	0,27	032609	89
3261	1	0,27	032616	89
3262	1	0,27	032623	89
3263	1	0,28	032630	89
3264	1	0,42	032647	89
3265	1	0,42	032654	89
3501	10/100	0,01	035013	65
3502	10/100	0,01	035020	65
3503	10/100	0,01	035037	65
3504	10/100	0,01	035044	65
3505	10/100	0,01	035051	65
3506	10/100	0,01	035068	65
3511	10/100	0,01	035112	65
3512	10/100	0,01	035129	65
3513	10/100	0,01	035136	65
3514	10/100	0,01	035143	65
3521	10/100	0,01	035211	65
3522	10/100	0,01	035228	65
3523	10/100	0,01	035235	65
3524	10/100	0,01	035242	65
4240	1	0,23	042400	108
5000	2/16	0,045	050009	79
5001	2/16	0,05	050016	79
5002	2/16	0,05	050023	79
5003	2/16	0,05	050030	79
5004	2/16	0,05	050047	79

**REFERENZE STRIP / STRIP ITEMS**

REF	m	Kg/m	EAN	pag
1129	1/25 pz	0,18	011291	115
1130	1/25 pz	0,12	011307	115
1131	1/25 pz	0,12	011314	115
1133	1/12 pz	0,27	011338	115
1134	1/12 pz	0,27	011345	115
1138	25	0,17	011383	116
1139	25	0,17	011390	116
1166	25	0,20	011666	116
1167	25	0,23	011673	116
1168	30	0,30	011680	119
1169	30	0,25	011697	119
1170	30	0,50	011703	119
1171	30	0,25	011710	119
1172	30	0,48	011727	119
1173	30	0,50	011734	119
1174	30	1,10	011741	119
1175	30	0,50	011758	119
1176	30	0,47	011765	119
1178	30	0,58	011789	119
1179	30	0,55	011796	119
1180	30	0,37	011802	119
1181	30	0,34	011819	119
1182	30	0,63	011826	119
1183	30	0,38	011833	119
1184	30	0,72	011840	119
1185	20	0,40	011857	119
1186	20	0,38	011864	119
1187	30	0,73	011871	119
1188	30	0,63	011888	119
1189	30	0,95	011895	119
1190	30	0,95	011901	119
1191	30	0,94	011918	119
1192	30	1,30	011925	119
1193	20	1,30	011932	119
1194	30	1,70	011949	119
1195	30	0,92	011956	119
1196	30	1,22	011963	119
1197	30	0,98	011970	120
1198	30	1,21	011987	120
1199	30	1,38	011994	120
1200	30	1,85	012007	120
1201	30	1,85	012014	120

5005	2/16	0,05	050054	79
5006	2/16	0,05	050061	79
5007	2/16	0,05	050078	79
5008	2/16	0,05	050085	79
5009	2/16	0,05	050092	79
5010	2/16	0,01	050108	79
5011	2/16	0,01	050115	79
5012	2/16	0,01	050122	79
5013	2/16	0,01	050139	79
5014	2/16	0,01	050146	79
5015	2/16	0,01	050153	79
5016	2/16	0,01	050160	79
5017	2/16	0,01	050177	79
5018	2/16	0,01	050184	79
5019	2/16	0,01	050191	79
5020	2/16	0,01	050207	79
5021	2/16	0,01	050214	79
5022	2/16	0,01	050221	79
5023	2/16	0,01	050238	79
5024	2/16	0,01	050245	79
5025	2/16	0,01	050252	79
5026	2/16	0,01	050269	79
5027	2/16	0,01	050276	79
5028	2/16	0,01	050283	79
5029	2/16	0,01	050290	79
5030	2/16	0,09	050306	79
6000	1/18	0,35	060008	41
6001	1/18	0,35	060015	41
6002	1/18	0,30	060022	41
6003	1/18	0,30	060039	41
6004	1/36	0,27	060046	41
6005	1/36	0,27	060053	41
6008	1/32	0,39	060084	41
6009	1/32	0,39	060091	41
6010	1/32	0,44	060107	41
6011	1/32	0,44	060114	41
6012	1/32	0,35	060121	41
6013	1/32	0,35	060138	41
6014	1/18	0,35	761110	41
6015	1/18	0,35	761127	41
6016	1/36	0,21	761134	41
6017	1/36	0,21	761141	41
6020	1/4	1,85	761103	42
9058	1/16	0,50	090586	70

9060	1/16	0,66	090609	70
9072	1/10	0,83	090722	70
9074	1/10	0,97	090746	70
9082	2	1,34	090821	70
9111	1/36	0,37	091118	70
9119	1/32	0,44	091194	70
9125	1/16	0,54	091255	70
9128	1/16	0,47	091286	70
9129	1/16	0,52	091293	70
9134	1/16	0,66	091347	70
9152	1/10	0,54	091521	70
9155	1/10	0,78	091552	70
9158	1/10	0,83	091583	70
9176	1/10	0,61	091767	70
9177	1/10	0,72	091774	70
9182	1/10	1,20	091828	70
9188	1/10	1,08	091880	70
9194	1/10	1,23	091941	70
9210	1	3,81	092108	73
9234	1	0,11	092344	73
9235	1	4,80	092351	73
9258	1	5,20	092580	73
9259	1	5,20	092597	73
9603	1	1,20	096038	73-191
9606	1	0,80	096069	73-191
9609	1	1,70	096090	73-191
9611	1	1,89	096113	73-191
9619	1	2,65	096199	73-191
9624	1	5,00	096244	73-191
9630	1/24	0,27	096304	30
9631	1/18	0,44	096311	31
9632	1/16	0,76	096328	31
9634	12/96	0,17	096342	56
9635	12/96	0,18	096359	48
9638	1/32	0,45	096380	70
9639	1/16	0,61	096397	70
9640	1/10	0,84	096403	70
9916	1/16	0,97	099169	70
9921	1/10	0,93	099213	70
9923	2	1,34	099237	70

**Packaging**

**1** = Confezione singola / Single pack

**B** = Confezione singola in blister / Blister single pack









REF	m	Kg/m	EAN	pag
1202	30	0,96	012021	120
1204	1/10 pz	1,90 / pz	012045	120
1205	1/10 pz	2,62 / pz	012052	120
1210	125	0,11	012106	116
1211	125	0,14	012113	116
1212	62,5	0,21	012120	116
1215	100	0,05	012151	116
1218	25	0,11	012182	117
1219	100	0,06	012199	116
1220	30	0,05	012205	118
1221	30	0,04	012212	118
1222	30	0,05	012229	118
1223	30	0,08	012236	118
1224	30	0,20	012243	118
1225	30	0,09	012250	118
1226	30	0,12	012267	118
1227	30	0,07	012274	118
1228	30	0,11	012281	118
1229	30	0,09	012298	118
1230	125	0,15	012304	118
1231	30	0,16	012311	118
1232	30	0,12	012328	118
1233	125	0,11	012335	118
1234	30	0,12	012342	118
1235	30	0,12	012359	118
1236	30	0,12	012366	118
1237	30	0,24	012373	118
1238	30	0,14	012380	118
1239	30	0,14	012397	118
1240	30	0,12	012403	118
1241	30	0,13	012410	118
1242	30	0,24	012427	118
1243	30	0,22	012434	118
1244	30	0,22	012441	118
1245	30	0,22	012458	118
1246	25	0,11	012465	117
1247	25	0,11	012472	117
1248	62,5	0,11	012489	117
1249	62,5	0,11	012496	117
1254	62,5	0,11	012540	117
1255	62,5	0,11	012557	117
1261	62,5	0,11	012618	117

REF	m	Kg/m	EAN	pag
1262	62,5	0,18	012625	117
1263	62,5	0,11	012632	117
1264	62,5	0,18	012649	117
1265	30	0,29	012656	117
1266	30	1,00	012663	117
1267	30	0,31	012670	117
1268	30	1,14	012687	117
1269	30	0,68	012694	117
1270	30	1,44	012700	117
1271	100	0,08	012717	117
1272	62,5	0,20	012724	117
1273	25	0,42	012731	117
1274	25	0,43	012748	117
1275	30	0,84	012755	117
1276	30	0,30	012762	117
1277	25	0,18	012779	117
1278	30	2,02	012786	117</





## LEGENDA

### TIPOLOGIA FILO / TYPE FILAMENT

-  **Acciaio / Steel**  
**Acciaio Ottonato /  
Brass Plated Steel**
-  **Inox / Stainless Steel**
-  **Ottone / Brass**
-  **Cordicella  
d'acciaio Liz /  
LIZ Steel Cord**
-  **Cordicella  
d'acciaio Liz Inox/  
LIZ Stainless Steel  
Cord**
-  **Nylon Abrasivo /  
Abrasive Nylon**  
Filamenti in Nylon Abrasivo:  
O.A. = Ossido di Alluminio  
C.S. = Carburo di Silicio  
CERAMIC = grana abrasiva ceramica  
Abrasive Nylon filaments:  
O.A. = Aluminium Oxide  
C.S. = Silicon Carbide  
CERAMIC = abrasive ceramic grit
-  **Nylon**
-  **Tampico**  
Fibra vegetale / Plant fiber
-  **PP**  
Polipropilene / Polypropylene

## LEGENDA

### STILE FILO / WIRE STYLE

-  **Filo Ondulato /  
Crimped wire**
  - Alto carico di rottura  
*High tensile strength*
  - Indicato per alte velocità di  
rotazione  
*Suitable for high rotational speeds*
  - Lunga durata  
*Long lifetime*
  - Convenienza costo/durata  
*Cost/lifetime convenience*
-  **Mazzetti Ritorti /  
Twist knots**
  - Elevata aggressività  
*High aggressiveness*
  - Lunga durata  
*Long lifetime*
-  **Cordicella LIZ /  
Liz steel cord**
  - Elevatissimi carichi di rottura  
*High tensile strength*
  - Ottime stabilità dimensionali  
*Great dimensional stability  
(size retention)*

[sitbrush.com](http://sitbrush.com)

@sitbrush



08002034 - 10 - 20 - 1750



**SIT SOCIETÀ ITALIANA  
TECNOSPAZZOLE S.p.A.**

Via Porrettana 453  
40033 Casalecchio di Reno  
Bologna - Italy  
Tel +39 0516113211  
Fax +39 051574319  
info@sitbrush.com  
P.I. - VAT 00626581201

**INDUSTRIAL BRUSHES  
MANUFACTURER WITH  
QUALITY MANAGEMENT  
SYSTEM CERTIFIED  
ISO 9001**



**SITBRUSH.COM**