

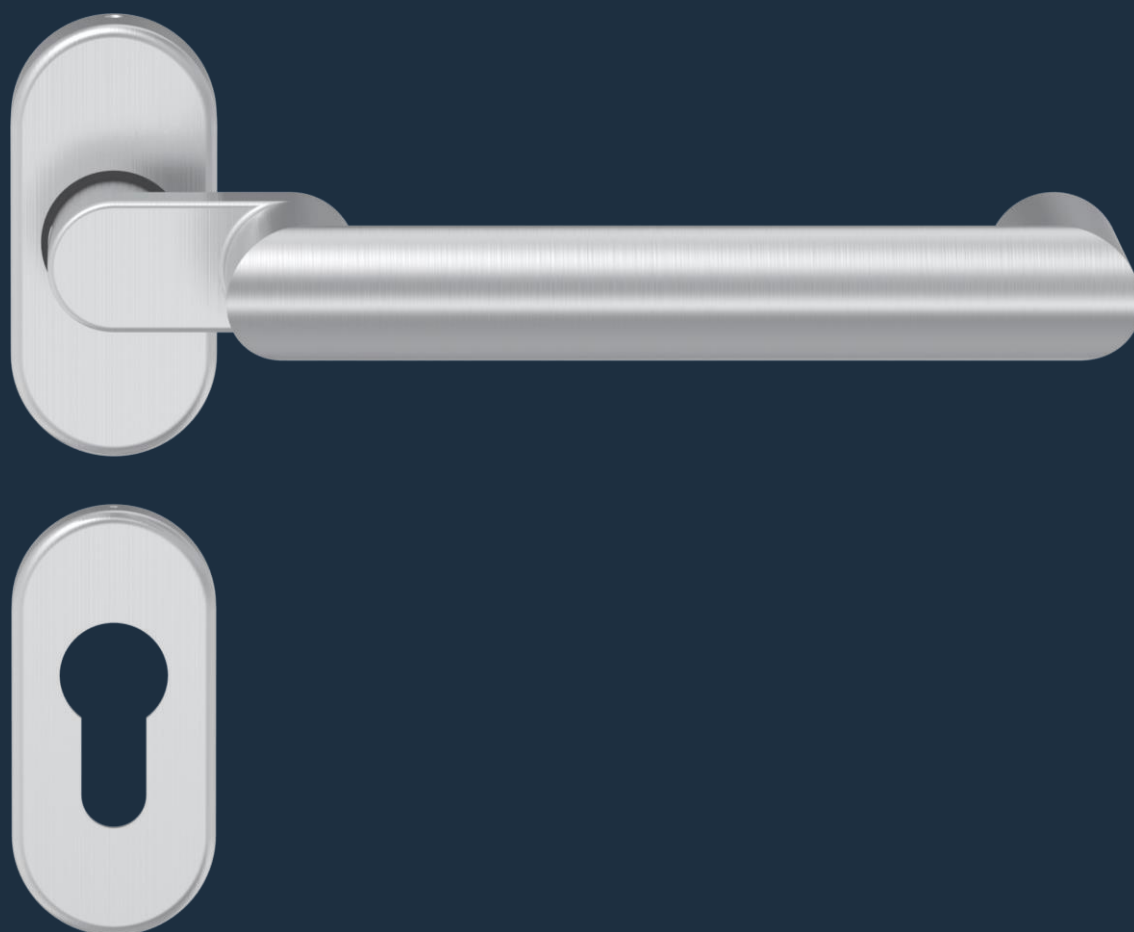

ECO D-335

Informacije o izdelku



SISTEMSKA TEHNOLOGIJA ZA VRATA

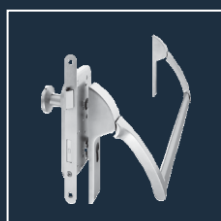
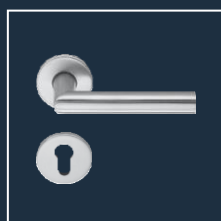

Značilnosti izdelka

Testirano po	EN 1906							
Z trnom 9 mm acc. po DIN 18273 protipožarna preizkušena	F							
Oblika vzvoda za evakuacijska vrata in zasilne izhode	EN 179							
Povratna vzmet	D							
Ležaj brez vzdrževanja	D							
Kovinska montažna podloga	D							
Skriti vijaki	D							
DIN levo / desno	D							
Klasifikacijski ključ EN 1906								
<table border="1"> <tr> <td>4</td> <td>7</td> <td>-B</td> <td>140</td> <td></td> <td></td> <td>A</td> </tr> </table>		4	7	-B	140			A
4	7	-B	140			A		
D-DA X-NE								

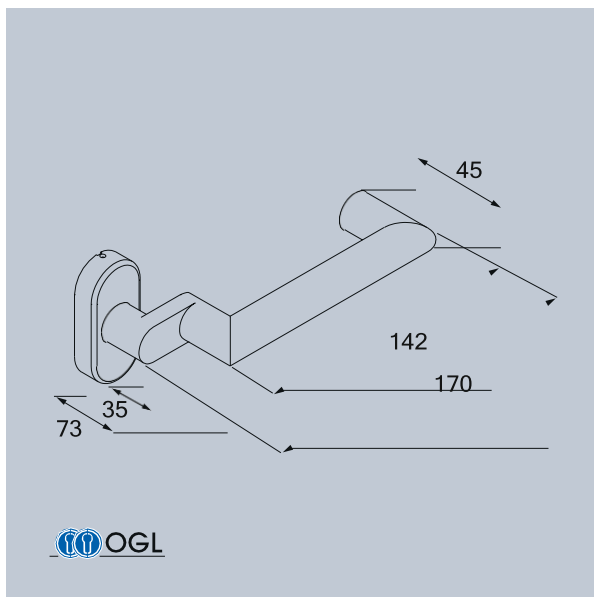
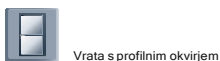

Material:



Tehnologija ležajev:



DRUŽINA IZDELKOV D-300

Standardna kljuka

Dolg/kratek ščit

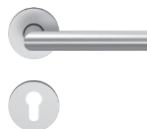

D-310



D-330



D-330



D-330

Kljuka z ovalno rozeto

Varnostna kljuka

Okenska kljuka



D-310



D-315

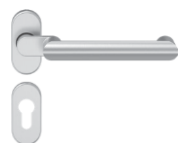

D-335



D-310



D-315



F-310

D-335 Ovalna rozeta



D-335 Vratna kljuka z ovalno rozeto z OGL – tehnologija tornih ležajev

Vodilo vzvoda je sestavljeno iz zaprtega tornega ležaja brez vzdrževanja s samo mazalno plastiko. Na voljo s fiksnim ali vrtljivim gumbom in močno povratno vzmetjo. Izravnajte talno vrtnico, vrtnanje z večjim vzvodom ni potrebno. Na voljo z ali brez pozicionirnih čepov.

Razred kategorije uporabe 4, pozicionirni čepi $\varnothing 8 \times 5$ mm

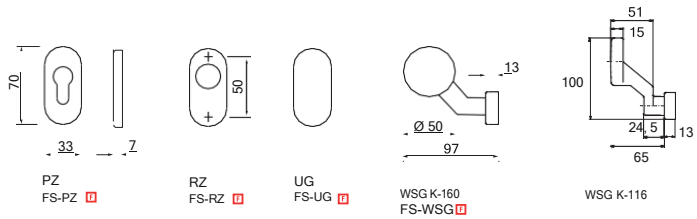

OGL – KLJUKA OVALNA ROZETA

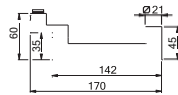

EN 1906 EN 179 F

F = 4 7 - B1 1 4 0 A



			Kompleti			Gumb			Rose		
S	21 mm	8 mm	178432,46	185305,46	385340,46	178218,46	178200,46	178202,46	176850,46	176852,46	176851,46
F	21 mm	9 mm	178430,46	385305,46	385310,46	178217,46	178200,46	178204,46	176850,46	176852,46	176851,46

Končna obdelava: satinirano krtačeno nerjaveče jeklo. PVD in polirani na zahtevo

*Osnovna zaščita vklj. ognjevarna plošča

OGL – KLJUKA OVALNA ROZETA

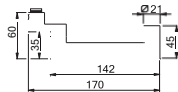

EN 1906 EN 179 F

F = 4 7 - D1 1 4 0 A



			Kompleti			Gumb			Rose		
S	21 mm	8 mm	178432,30	185305,30	385340,30	178218,30	178200,30	178202,30	177850,30	177852,30	177851,30
F	21 mm	9 mm	178430,30	385305,30	385310,30	178217,30	178200,30	178204,30	177850,30	177852,30	177851,30

Zaključek: anodiziran aluminij F1 in F9, druge barve na zahtevo**

*Osnovna zaščita vklj. ognjevarna plošča

** Upoštevajte naše opombe na naslednjih straneh.



V Sloveniji prodaja iz zastopa:
Pantal d.o.o.
Žnidarčičeva 31
5290 Šempeter pri Gorici
Spletna stran: www.pantal.si
Informacije: info@pantal.si

EKOSchulte GmbH & Co. KG
Iserlohner Landstraße 89
D - 58706 Menden

Telefon: + 492373 / 9276 - 0
faks: + 492373 / 9276 - 40

info@eco-schulte.de

www.eco-schulte.de