



















**CONEGLIANO
SERRAMENTI**

FORZA

GENERAL CATALOGUE

**SPECIAL SHUTTERS
INOX & ALUMINIUM
FOLDING GATES
SHUTTERS
WINDOW GRILLES**



	Company	<i>pag 4</i>
	Folding Gate "Sicuro"	<i>pag 6</i>
	Folding Gate	<i>pag 10</i>
	Articulated Gate	<i>pag 14</i>
	Security Gate	<i>pag 18</i>
	Insulated rolling shutter DP77	<i>pag 22</i>
	Insulated rolling shutter DP105	<i>pag 24</i>
	Sliding shutter	<i>pag 28</i>
	Blank shutter	<i>pag 30</i>
	Micro perforated shutter	<i>pag 32</i>
	Tubular rolling shutter	<i>pag 36</i>
	Tubonda/Tondino rolling shutter	<i>pag 38</i>
	Folding shutter	<i>pag 40</i>
	Special products: Elite	<i>pag 42</i>
	Polycarbonate	
	Windowed in aluminium	
	Liberty	
	Mix P 60	
	Automation	<i>pag 48</i>
	FORZA	<i>pag 50</i>



COMPANY

HISTORY



Founded in 1977 for the craftsman made production of folding gates and rolling shutters, the company evolved quickly and soon, few years later, introduced innovative machinery for increasing the productive capacity and controlling the quality of the final product. Nowadays, the company offers a wide range of products and a general excellent service.

PROJECT



Specialized in the design of systems for the closure and protection of buildings in commercial and business centers as well as in industrial and domestic sites. Conegliano Serramenti is today one among the few companies who designs and manufactures special closures for bar counters of hotels, cruiser ships and high-speed trains and produces special closures in stainless steel and aluminium.

PRODUCTION



The company is proud of the excellent quality level of its products, thanks to its expert and highly specialized workers, able to accept the challenges created by the new technologies, like for example the robotic finishing.



1977   

2013  **CONEGLIANO SERRAMENTI**

EVOLUTION



Entrusting the heaviest and most hazardous works to the machines is a key factor of the success of Conegliano Serramenti. Introducing robots in the production line is not only a guarantee for our competitiveness but also for a safe and qualified job to our workers.

SERVICE



In order to be successful in our market, we do not rely solely upon the excellent quality of the product but we strongly believe it is necessary to guarantee a timely and effective service; this is the continuous commitment of all our staff.

CERTIFICATION



All our products are certified by the CSI Institute of Milan, according to the norm UNI EN 13241-1. The conformity to the norm is further confirmed by the CE mark, applied to every product supplied.



Folding gate "Sicuro" Resistance class2 and class3 ENV 1627

"Sicuro" is certified class2 and class3 for the burglar resistance, according to the European Standard ENV 1627-1 and for the resistance against the corrosion according to the standard UNI 5687-73. Furthermore, it is patented as an industrial invention, CE certified and awarded "Eureka" by the European Union. This product is therefore able to satisfy the most demanding users.

It is available in several versions and dimensions and can easily meet the needs of the customers and adapt to any requirement for the installation.

Sicuro is perfectly suitable for the protection and closing of any type of opening in both residential and commercial buildings. Once completely opened, the gate has really a little size and may be further rotated by 90° in order to let the opening almost completely available for the user, while, when completely closed, it allows the flow of air and light.



Internal core made of stainless steel and outer casing made of painted aluminium



1. vertical bars made of reinforced stainless steel
2. perimetric frame made of extruded aluminium and corner joints
3. outer casing of the vertical bars made of rounded aluminium profile
4. lock designed with 3 blocks: 1 central hook , 1 upper and 1 lower bars; lock front made of stainless steel.
5. sliding carriages made of a self-lubricating thermoplastic, highly resistant to wear, not deformable at both high and low temperature.
6. levers, made of high strength low-alloy steel , galvanized and painted.
7. side profiles for adjusting the inequality of the walling.
8. a properly shaped lower guide prevent the posts from exiting.
9. the joints between the guides and the posts, the stops of the levers, the protective parts of the edges of the posts are all made of thermoplastic.
10. the joints between the levers are hidden.



The post which carry the lock is equipped with a 4 wheels sliding carriage



Certificates for the burglar resistance class2 and class3 and for the resistance against corrosion



Folding gate “Sicuro” Resistance class2 and class3 ENV 1627

Constructive features:

- Standard colours of the folding gates, levers included: white RAL 9010, green RAL 6005, Micaceous iron oxide grey. Upon demand(*), ivory RAL 1013 and brown RAL 8017 are available.
- Vertical bars made of stainless steel, reinforced
- Perimetric frame made of reinforced extruded aluminium
- Lock designed with 3 blocks and lock front made of stainless steel.
- 3 keys included
- 5 pins cylinder lock
- Levers, made of high strength low-alloy steel , galvanized and painted.
- Side profiles for adjusting the inequality of the walling.
- The joints between the levers are hidden.
- Sliding carriages and sliding parts are all made of a self-lubricating thermoplastic, highly resistant to wear, not deformable at both high and low temperature.

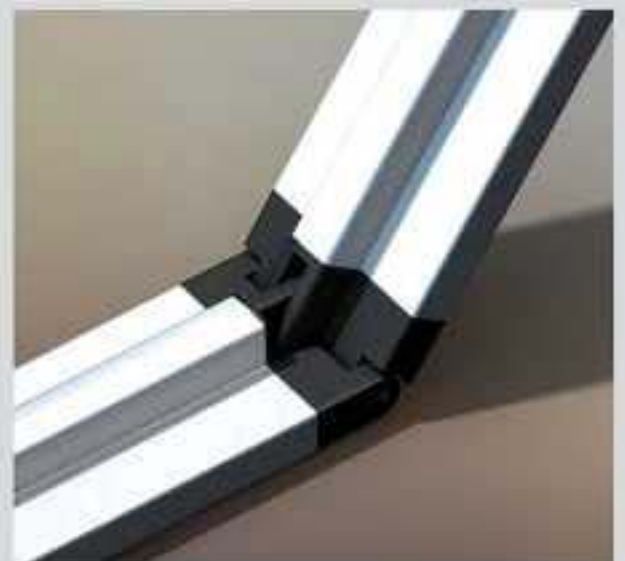

The lower guide may be raised from the ground.



^ Lower guide, not raisable, and shaped so that the upper part is rounded.

The folding gates Sicuro successfully comply with the following 3 tests:

1. Resistance to static load: a load is applied to the most critical parts of the gate, like for example the lock, the angles of the frame, hinges and pins.

2. Resistance to dynamic load: a load of 30kg hits the gate on the angles and on the center .

3. Resistance to burglar: the resistance to burglar is codified according to the severity of the assault

Class 1 - the occasional burglar attempts to force the gate by using his physical force only

Class 2 - the occasional burglar attempts to force the gate by using his physical force and some simple tools

Class 3 - the experienced burglar attempts to force the gate by using his physical force and heavy duty tools



Lock with 3 blocks, 1 horizontal central and 2 vertical on the top and bottom of the frame

Width of the opening (mm)	N° of posts	Width of the folded gate	
306	410	2	132
411	562	3	159
563	714	4	185
715	866	5	212
867	1018	6	239
1019	1170	7	265
1171	1322	8	292
1323	1474	9	319
1475	1626	10	345
1627	1778	11	372
1779	1930	12	399
1931	2082	13	425
2083	2234	14	452
2235	2386	15	479
2387	2538	16	505
2539	2690	17	532
2691	2842	18	558
2843	2994	19	585
2995	3146	20	612



Folding gate

Table showing the overall dimensions of the single leaf folding gate and relative number of posts

The folding gates are widely used in the protection of the entrances and windows of residential buildings and of commercial sites like shops, stores, offices.

The following features make the folding gates the best choice now in terms of good quality and low price: reduced overall dimensions, readiness for installation, tailor-made design, easiness for use and maintenance, robustness, durability, wide range of available models and attractive appearance of materials and colours.

The folding gates are entirely built in galvanized steel and may be finished with polyurethane powder fire coating suitable for outdoor application. The posts are made of 2 opposite "U" shaped profiles; dimensions of the section of the profile are 15x15x15mm available in the thicknesses 1,0mm, 1,2mm, and 15x20x15mm available in one unique thickness having reinforced rounded section. The posts are connected by the means of straight or waved levers, made of steel, available in thicknesses of 2,0 / 2,5 / 4,0mm. The posts lean on ball bearing wheels which scroll in upper and lower guides; the lower guide is raisable if needed. The closure is made by a double block or reinforced YALE or SEA lock. Upon request, the gate type 15x15x15mm is available in stainless steel AISI 304



Profile of the type 15x15x15mm



Profile of the type
15x20x15mm having
reinforced rounded section

FOLDING GATES

Models	CS ROMBO A	CS ROBUS	CS INOX
Material	Galvanized steel	Galvanized steel	St. steel
Profile dimensions (mm)	15x15x15	15x20x15	15x15x15
Profile thickness (mm)	1,0 / 1,2	1,0	1,0
Lever thickness (mm)	ROMBO (rhombus) 2,0 2,0+2,0 4,0 4,0+4,0	ROMBO (rhombus) 2,0 2,0+2,0 4,0 4,0+4,0	ROMBO (rhombus) 2,0

Models	CS ONDA	CS ROBUS ONDA
Material	Galvanized steel	Galvanized steel
Profile dimensions (mm)	15x15x15	15x20x15
Profile thickness (mm)	1,0 / 1,2	1,0
Lever thickness (mm)	ONDA (wave) 2,5 2,5+2,5 4,0 4,0+4,0	ONDA (wave) 2,5 2,5+2,5 4,0 4,0+4,0



Folding gate

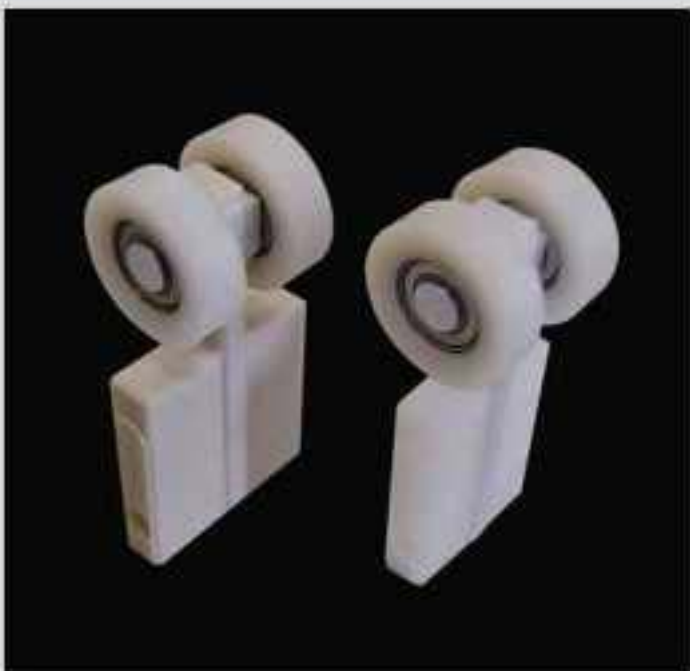

Upper ball bearing sliding carriages



Lower driving sliding carriages



Rombo

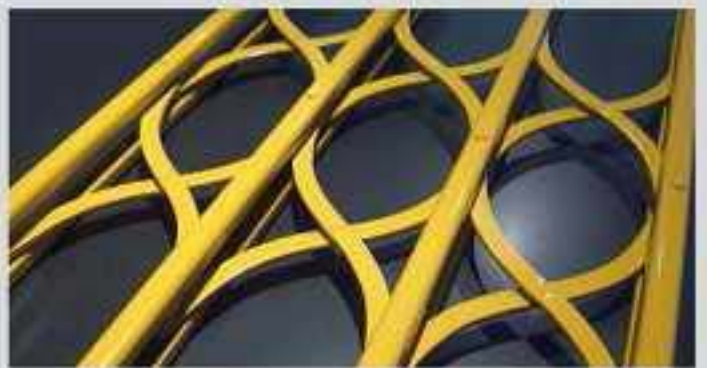

Onda Classica



Onda Loira



Onda Danubio



ERIS



INDRA

Articulated door and window grilles **Class3 of Burglar resistance acc. ENV 1627**

STANDARD SUPPLY:



2 Leaves door frame
 - upper gap 40 mm
 - upper horizontal profile 40x30mm with central support
 - lower horizontal profile 20x30mm



1 Leaf door frame
 - upper gap 40 mm
 - upper horizontal profile 40x30mm
 - lower horizontal profile 20x30mm

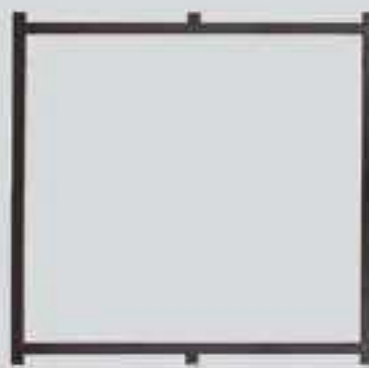

2 Leaves window frame
 - upper gap 40mm
 - upper and lower horizontal profiles 40x30mm with central supports
 - lower gap 40mm



1 Leaf window frame
 -upper gap 40mm
 -upper and lower horizontal profiles 40x30mm
 - lower gap 40mm

-valid for fixed frames also



TALIA

Safety articulated door and window grille

The grille is built with rectangular tubing 60*30mm , integrated hinges and lock pins for the "T" serie (see photo). The lock is inserted in the post. The closing is operated by a handle which actuates 2 vertical pins . It is further secured by a safety cylinder lock, accessible from both sides of the grille (internal or external) or one side only, upon request.

Safety door and window grille

The grille is built with rectangular tubing 60*30mm , integrated hinges. The opening may be inward or outward or both, upon request. The lock is inserted in the post. The closing is operated by a handle which actuates 2 vertical pins . It is further secured by a safety cylinder lock, accessible from both sides of the grille (internal and external) or one side only (internal or external), upon request.

Fixed safety door and window grille

The grille is built with rectangular tubing 60*30mm (no hinges).

The sliding grille is built with rectangular tubing 70/95*35mm, complete with a hook lock and prepared for a European cylinder lock.

Internal mantel

The safety and decorative values rely upon the internal mantel built as a partial grid with round/squared bars of 14mm and horizontal flat bars 30x6mm, bored 140mm step approx.

In addition, the model Indra is endowed with round/squared bosses 38mm high.

The model Talia is endowed with circles made of a 14x3mm ribbon.

All models are entirely galvanized and finished with polyurethane powder fire coating suitable for outdoor application.



Standard 20cm cantilevered opening



Detail of both inward and outward opening

Style "T"

Style "S"



Articulated door and window grilles

Class3 of Burglar resistance acc. ENV1627

Sketches showing the opening modes of the articulated door and window grilles

The articulated door and window grille may open inward and/or outward, partially (90°) as a first opening and fully (180°) as a second opening, in this case, overlapping for instance a shutter. This allows the perfect integration with the existing system of shutters.

The patented, self-locking and revolving junction is hidden, and gives to the grille a clean and sober appearance combined with the strength of a classic non-articulated grille.

The frames are customized according to the customer's needs. The installation is quite simple and quick. The use, if required, of special side profiles for adjusting the inequality of the walling, keeps unchanged the aesthetic and safety characteristics of the door and window grille.

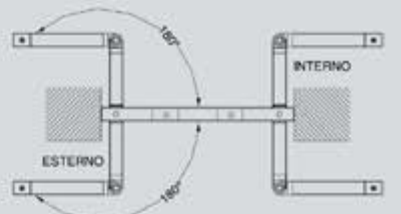
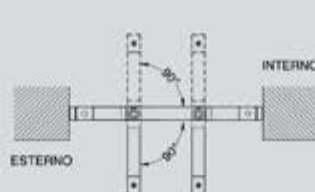
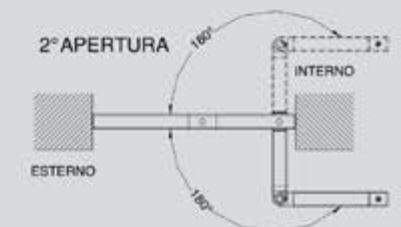
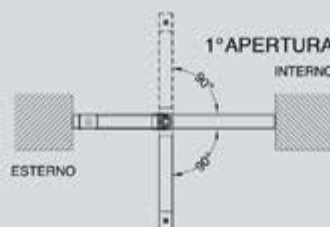
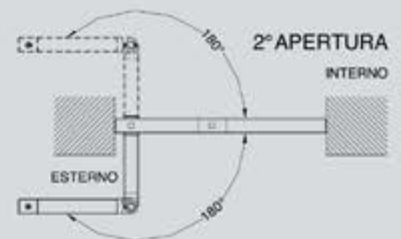
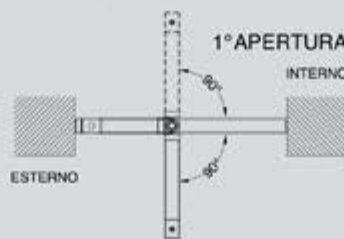



Opening handles



detail of the stopper



"T"serie detail



IGEA



CLODIA

Safety door and window grilles

The Safety door and window grilles find their main application in the protection of private buildings and shops thanks to their robustness and pleasant appearance.

The patterns, although simple, convey a sense of love for genuine and beautiful things. These so robust artefacts always result integrated in the building with elegance. The view of the hammered iron and the shades of the varnishing produce a pleasant antique warmth.

We propose a wide range of colours in order to make the products fully harmonized with your building. They are manufactured with a 55mm wide perimetral, coplanar and armored profile, 14mm diameter pin hinges and arrangement for stroke seals. The hidden multi-point lock have a frontal access and is arranged for the European cylinder.



AGAR



ONIA



CELI

Sketches showing the opening modes of the sliding grille

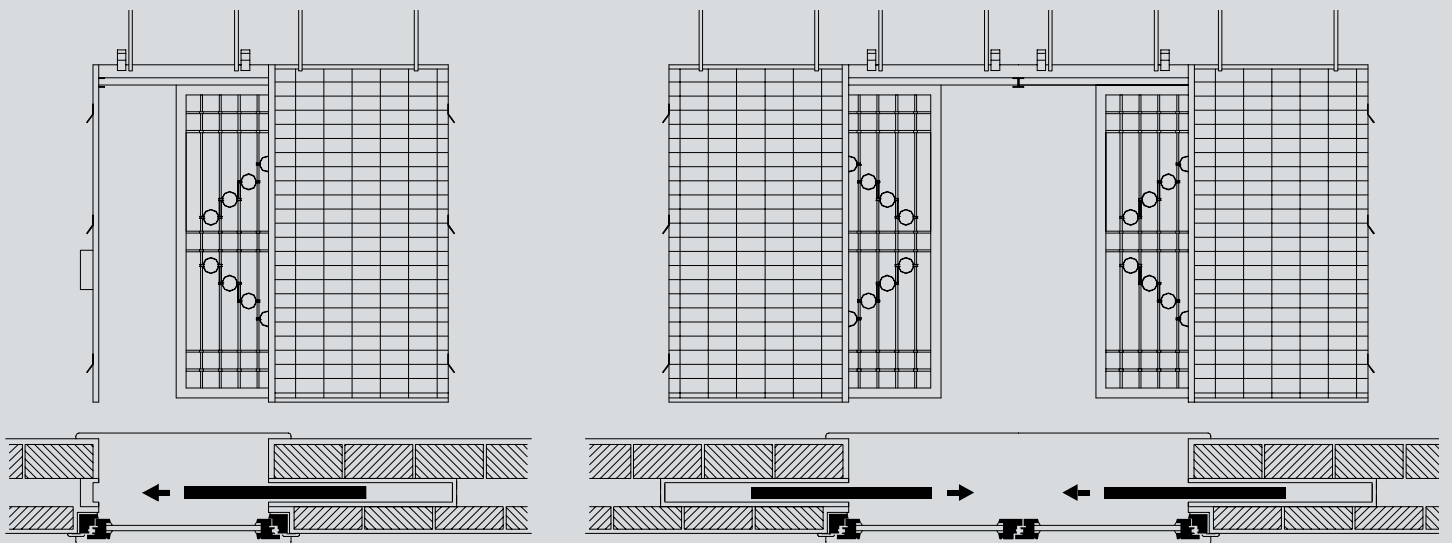

Built in the versions: fixed, opening in 1, 2, 3, 4 leaves and sliding in a built-in box.



EDRA



CICLA

Safety door and window grilles

Door and window grilles, sliding in a built-in box

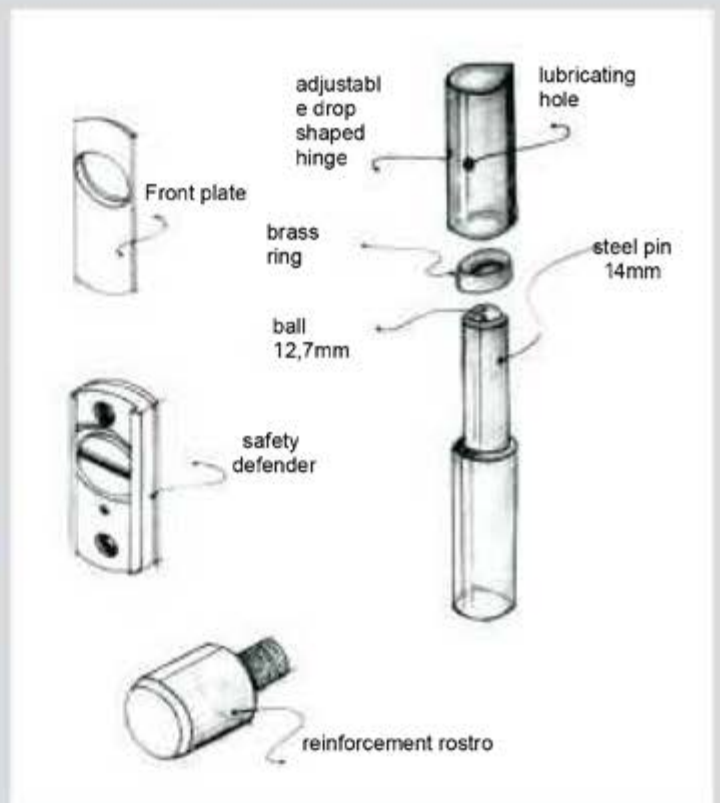



TRIO



RILEY



UNIKA

Security gate

Material of the frame	Galvanized and painted steel
Material of the curtain	12, 14, and 16mm round and squared hammered iron, galvanized and painted
Thickness of the profiles (mm)	2,0 and 3,0
Weight Kg/m2	min. 31, max. 45
Types	1, 2, 3 and 4 leaves available Fixed within or out of the opening Sliding in a built-in box Sliding out of the opening

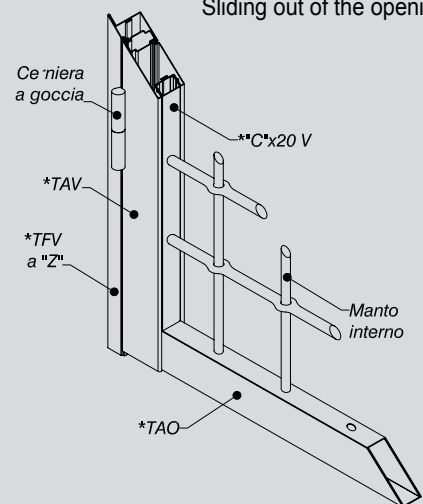



Insulated rolling shutters DP 77

Insulated rolling shutters are made of 2 plastified steel or painted aluminium profiles, tightly clamped together in order to form the body of the basic slat of the shutter. The formed slat is filled with polyurethane foam, to provide thermal insulation. The shutters are supplied completely assembled and equipped with nylon side stoppers, extruded aluminium end slat with gasket and painted same colour of the curtain. The side guides are made of extruded aluminium, dimensions 40x36x40mm and 60x36x60mm, endowed with brush or gasket. The supports of the shaft are made of galvanized steel. Upon request, long or short windows may be opened, with or without a plexiglass panel. Insulated rolling shutters can be operated by hand or by motor. According to the size of the shutter, alternative solutions are available:- for small to medium sizes (max. 100kg), a tubular motor drives a round or octagonal cross section shaft.- for small, medium and large sizes (max. 300kg), one or two axial motors drives a spring-loaded shaft.- for very large industrial applications, a side motor operates a shaft without any aid of springs. The peculiarity of these shutters is the capacity of giving a high level of thermal insulation and noise protection., and are therefore, perfectly suitable to protect for example private garages, medium-sized industrial openings and, generally, any place which needs to be closed, when the thermal stability is required. Moreover, single-wall (uninsulated), blank or windowed shutters, made of extruded aluminium, are available with the same standard accessories of the insulated shutters





Wide Range Of Colors Available

Plastified steel:
RAL1015-6005-7004-8015-8019-
9002-9010
Light/dark faux wood
Raffaello tints:
Green-Grey-Brown

Painted aluminium:
RAL1013-6005-7004-8019
-9006-9010
Dark faux wood

SINGLE-WALL ROLLING SHUTTER P 77

Overall thickness (mm)	19,00
Material	Extruded aluminium Th. 2,0mm
Weight Kg/m2	12,10
Weight Kg/m	0,83
Maximum opening width (m)	6,50 (approx.)
Wind pressure resistance	

DOUBLE-WALL INSULATED ROLLING SHUTTER DP 77

Overall thickness (mm)	19,00	19,00
Profile thickness (mm)	0,62 approx.	0,50 approx.
Material	Plastified steel with polyurethane foam	Painted aluminium with polyurethane foam
Weight Kg/m2	13,00	5,00
Weight Kg/m	1,00	0,382
Max opening width (m)	6,00 (approx.)	6,00 (approx.)
Density of the foam in free expansion	g/l 11-47,5	g/l 11-47,5
Flame resistance	Classe of reaction 1	Class of reaction 1
Resistance in salt spray (h)	>500	>1000
Wind pressure resistance	Cl. 1 (up to W=4,5m) Cl. 4 (up to W=3,5m)	Cl. 1 (up to W=5,5m) Cl. 4 (up to W=4,0m)



Insulated rolling shutters DP 105

Insulated rolling shutters are made of 2 plastified or painted steel or painted aluminium profiles, step 93mm, tightly clamped together in order to form the body of the basic slat of the shutter. The formed slat is filled with polyurethane foam, to provide thermal insulation.

Endowed with robust galvanized guides, variable depth 60 to 80mm; gaskets; supports for the shaft.

The curtains are supplied completely assembled and equipped with nylon side stoppers; the end slat, in contact with the ground, is made of extruded aluminium, rubber insulated, powder fire coated in black (standard).

Two alternative winding shafts are available:

- zinc-plated steel , diameters 76-89-101mm, spring-loaded in robust spring containers of diameters 240-280mm according to the dimension of the shaft.

- painted steel , diameters 159-168-193-219-2244mm and higher.

Hand operated shutters are equipped with spring-loaded shaft.

Motor operated shutters can be equipped alternatively with spring-loaded shaft driven by an axial motor mounted on the shaft or with a shaft, not spring-loaded, driven by a side motor.

A robust tear-proof kit (see picture pg.27) is supplied in certain peculiar circumstances: application in windy areas, in rooms where resistance to burglar is needed, outdoor where the class of resistance to the wind must be certified.

Upon request, long or short windows may be opened, with or without a plexiglass panel.



DP 105



Detail of a guide and relative gasket

Chain drive side motor

INSULATED ROLLING SHUTTER DP 105

Overall thickness (mm)	20,00
Profile thickness (mm)	0,692
Material	Plastified steel <i>(*limited stock)</i>
Weight (kg/m ²)	13,50
Weight (kg/m)	1,18
Max. opening width (m)	12,00 (approx.)
Density of the foam in free expansion (g/dm ³)	52
Flame resistance	Class of reaction B2
Resistance to salt spray (h)	>500
Noise level	25,5 dB
Wind pressure resistance	Classe 2 (up to W=7m x H=5m)

** will be replaced by:
painted steel and pre-painted aluminium*



Insulated rolling shutters DP 105

Motor operated shutters can be activated locally or remotely.

The complete kit of locally activated shutters includes an axial or side motor, a low voltage control unit and a European cylinder lock ready for unlocking. The kit for remotely activated shutters includes an axial or side motor, a control unit, a radio receiver, a remote control.

For all shutters, a further set of accessories is supplied, in order to fulfil the requirements for the safety Certification of the product.

These shutters replace the sectional shutters for large dimensions because safer and more robust . They are an ideal solution for the protection of garages, shops, rooms which require a high degree of safety, industrial openings, loading points, very large openings.

Endowed with tear-proof brackets, they are suitable for windy areas.



Tailor- made windows

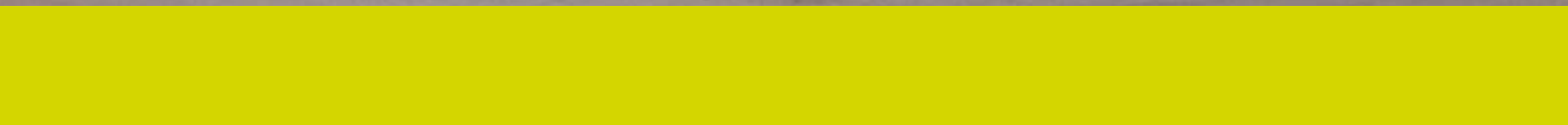

G-shaped rail with tear-proof bracket

PANEL OF COLORS

Pre-plastified steel	RAL 9016 9002 8017 7015 6005 5010 3000 1013
Painted steel	RAL 9016 9007 9006 9002 8014 7015 6005 5010 3000
Pre-painted aluminium	RAL 9016 9006
Galvanized upon demand	



Sliding shutter

Available in both insulated and un-insulated versions

The insulated SLIDING shutters typical features are the vertical position of the slats and the horizontal scrolling; the slats are made of two pre-painted aluminium profiles in RAL colors, tightly clamped together and filled with polyurethane foam to provide thermal insulation.

The standard supply kit always includes a remotely controlled motor and all necessary safety devices.

The high quality grade of thermal and noise insulation and the smooth, noiseless running make the SLIDING shutters an ideal solution for the closing of garages.

The un-insulated SLIDING P 112mm shutters show vertical position of the slats and scroll horizontally, can be galvanized or fire powder painted in several RAL colors.

The lower rail may be a U-shaped profile 35x35x35mm, embedded in the floor, or an β -shaped profile lying on the floor and designed to support the weight of a car.

The easy and smooth running of the shutters partly depends on the wheels which scroll in the rail; the wheels may be positioned in the lower or upper rail, according to the needs of the application.

These shutters are hand-operated only and supplied with Yale lock and side post.

All SLIDING shutters are particularly suitable for the protection of garages, warehouses and all places where the limited space under the ceiling doesn't allow the use of shutters having a vertical scrolling.



Internal view



Insulated SLIDING shutter

INSULATED SLIDING SHUTTER DP 77

Overall thickness of the slat (mm)	19,00
Thickness of the external plate	0,6 (approx.)
Material	Pre-painted aluminium
Weight (kg/m ²)	5,80
Weight (kg/m)	0,44
Max. opening width realizabile (mt.)	6,00 (ca.)
Density in free expansion	
Flame resistance	
Resistance in salt spray (h)	
Noise level	
Wind pressure resistance	

UN-INSULATED SLIDING SHUTTER P 112

Overall thickness of the slat (mm)	0,8
Material	Galvanized steel
Weight (kg/m ²)	8,80
Weight (kg/m)	0,98
Max. opening width (m)	3,00 (each leaf)
Wind pressure resistance	Class 3



Blank shutters P 115 P 97 P 73

Single-sheet shutters, built with blank horizontal slats hooked one another, upper winding, bottom slat equipped with handles and stops.

3 models are available: P 115 P 97 P 73.

The bottom slat is 140mm high for models P 115 and P 97, 100mm for the model P 73.

Windows with plexiglass may be optionally opened for model P 115 while ventilation slats are available for models P 97 and P 73.

All models are available in stainless steel.



Model P 115



Model P 97



Model P 73

BLANK SHUTTER P 115

Sheet thickness (mm)	0,8	1,2	1,0	1,2	0,8
Material	Galvanized steel	Galvanized steel	Aluminium	Aluminium	St. steel AISI 316
Weight kg/m ²	10,70	13,40	4,50	5,30	10,70
Weight kg/m	1,13	1,52	0,482	0,582	1,13
Maximum opening width (m)	15,00	15,00	5,00	5,00	15,00
Wind pressure resistance Class 2(*)	up to L=5,0m x H=2,0m	up to L=6,5m x H=2,0m	-	-	up to L=5,0m x H=2,0m

BLANK CURVED SHUTTER P 97

Sheet thickness (mm)	0,8	1,0	0,8
Material	Galvanized steel	Aluminium	St. steel AISI 316
Weight kg/m ²	12,50	5,20	12,50
Weight kg/m	1,13	0,482	1,13
Maximum opening width (m)	17,00	6,00	17,00
Wind pressure resistance Class 2(*)	up to L=6,5m x H=2,0m	-	up to L=6,5m x H=2,0m

BLANK SHUTTER P 73

Sheet thickness (mm)	0,8	1,0	0,6
Material	Galvanized steel	Galvanized steel	St. steel AISI 316
Weight (kg/m ²)	9,00	10,50	9,20
Weight (kg/m)	0,66	0,80	0,64
Maximum opening width (m)	5,00	5,00	5,00

(*) for particular needs, contact our technical dep.t



Micro-perforated shutters P 115 P 97 P 73

Single-sheet shutters, built with steps 115, 97, 73mm horizontal slats, in galvanized steel hooked one another, bearing micro-holes of • 4mm .

All models are available in stainless steel . Furthermore, models P 115 and P 97 are available in aluminium.

They all scroll in galvanized side rails having a U-shaped section of 30x22x30mm (P 73), 40x22x40mm - 40x25x40mm - 50x25x50mm - 70x27x70mm or alternatively in robust G-shaped side rails specially suited to the dimensions of the shutters, with or without gaskets.

3 models are available: P 115 P 97 P 73.

The bottom slat is 140mm high for models P 115 and P 97 , 100mm for the model P 73.

Nylon side-clips, for locking the slats and reducing the noise, may be supplied on models P 115 and P 97. the model P 73 may be equipped with side-clips in galvanized steel.



Special patterns and colors are available upon request



Stainless steel micro-perforated shutter P 73 with side-clips

MICRO-PERFORATED SHUTTER P 115

Sheet thickness (mm)	0,8	1,0	0,8
Material	Galvanized steel	Aluminium	St. steel AISI 316
Weight (kg/m ²)	9,50	m 4,00	9,50
Weight (kg/m)	1,13	0,406	1,13
Max. opening width (m)	13,50	5,00	13,50
Wind pressure resistance Class 2(*)	Up to W=5,0m x H=2,0m	-	Up to W=5,0m x H=2,0m
Aeration index of the shutter	24%	24%	24%

MICRO-PERFORATED CURVED SHUTTER P 97

Sheet thickness (mm)	0,8	1,0	0,8
Material	Galvanized steel	Aluminium	St. steel AISI 316
Weight (kg/m ²)	11,00	4,60	11,00
Weight (kg/m)	1,13	0,406	1,13
Max. opening width (m)	15,00	5,00	15,00
Wind pressure resistance Class 2(*)	Up to W=5,0m x H=2,0m	-	Up to W=6,5m x H=2,0m
Aeration index of the shutter	28%	28%	28%

(*) for particular needs, contact our technical dep.t



Micro-perforated shutters P 115 P 97 P 73

For all models, the bottom slat may be equipped with rubber stops. All blank and micro-perforated shutters P 115 AND P 97, in outdoor and windy exposure, are equipped with a robust Tear-proof kit (as shown in picture pg.35) which enhances the protection against intruders and allow the shutters to meet all the requirements of the standards for the Wind Pressure Resistance.

The shutters may be activated in the following alternative modes:

- axial motor mounted on a spring-loaded shaft
- side-motor which operates the shaft without the aid of springs
- tubular motor inserted into the shaft
- hand-operated and spring-loaded shaft

Several colours in RAL tints are available.

This product is particularly versatile: suited for the protection of shops, garages, loading points and, generally, any place that must be at the same time protected, visible, ventilated.



Special applications



G shaped side rail with tear-proof brackets

MICRO-PERFORATED SHUTTER P73		
Sheet thickness (mm)	0,8	1,0
Material	Galvanized steel	St. steel AISI 316
Weight (kg/m ²)	7,00	9,00
Weight (kg/m)	0,50	0,64
Max. opening width (m)	5,00	5,00
Aeration index of the shutter	38%	38%



Tubular Rolling shutters

The range of products includes 3 open shutters with rectangular mesh.

- the tubular shutter P 120 is made of horizontal tubes of 18mm diameter, linked each others with vertical galvanized connecting rods, 120mm step, 1,0 or 1,2mm thickness.

- the tubular shutter P 95 is made of horizontal tubes of 18mm diameter, linked each others with vertical galvanized connecting rods, 95mm step, 1,5mm thickness, reverse winding available.

- the tubular shutter P 60 is made of horizontal tubes of 14mm diameter, linked each others with vertical zinc-plated connecting rods, 60mm step, 2,0mm thickness, high resistance, reverse winding available, available in stainless steel also.

Several colours in RAL tints are available.

The tubular shutter P 60 is the most suitable for heavy duty applications.



The tubular shutter P 120 sight from inside



The tubular shutter P 60

TUBULAR SHUTTER P 60

Tube diameter (mm)	14,0	14,0	14,0
thickness (mm)	1,0	1,5	1,0
Material	Galvan.- steel	Aluminium	St. steel AISI 316
Weight (kg/m ²)	11,00	4,00	11,00
Max. opening width (m)	17,00	6,00	17,00

TUBULAR SHUTTER P 95

Tube diameter/thickness (mm)	18,0 / 1,0
Material	Galvanized steel
Weight (kg/m ²)	9,00
Max. opening width (m)	17,00

TUBULAR SHUTTER P 120

Tube diameter/thickness (mm)	18,0 / 1,0
Material	Galvanized steel
Weight (kg/m ²)	8,00
Max. opening width (m)	17,00



TUBONDA rolling shutters

The peculiarity of the TUBONDA and TONDINO rolling shutters is the waved-shaped mesh.

The curtain of the TUBONDA shutter is made of 2 galvanized steel waved tubes of 14mm diameter, 1,2mm thickness, linked together with galvanized moulded bands; in the reinforced version a third straight tube is interposed between the two waved tubes.

The curtain of the TONDINO shutter is made of 2 galvanized steel waved rods of 10mm diameter, shaped to form rhombuses, linked together with galvanized ribbed bands; in the reinforced version a third straight tube is interposed between the two waved tubes.

The open shutters are widely used in shops, shopping centers, business centers, where the internal vision of the room is appreciated and a good ventilation is needed, for safety requirements also.

The TONDINO shutter is the most suitable for heavy duty applications; the reverse winding is available for both TUBONDA and TONDINO.



Detail of the TUBONDA shutter



TONDINO rolling shutters

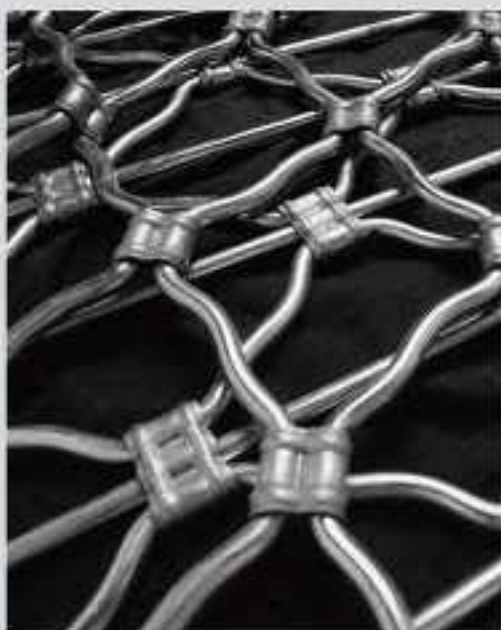

Detail of the TONDINO shutter

TONDINO STANDARD SHUTTER

Waved rods diameter (mm)	10,0
Material	Galvanized steel
Weight (kg/m ²)	12,00
Max. opening width (m)	7,50

TONDINO REINFORCED SHUTTER

Waved and straight rods diameter (mm)	10,0
Material	Galvanized steel
Weight (kg/m ²)	17,00
Max. opening width (m)	7,50

TUBONDA STANDARD SHUTTER

Waved tube	ø 14,0mm	ø 14,0mm	ø 14,0mm
- thickness (mm)	1,2	1,5	1,2
Material	Galvanized steel	Aluminium	St. steel AISI 304
Weight (kg/m ²)	11,00	3,60	11,00
Max. opening width (m)	9,00	9,00	4,00

TUBONDA REINFORCED SHUTTER

Waved and straight tube	ø 14,0mm	ø 14,0mm	ø 14,0mm
- thickness (mm)	1,2mm	1,5mm	1,2mm
Material	Galvanized steel	Aluminium	St. steel AISI 316
Weight (kg/m ²)	16,00	4,80	16,00
max. opening width (m)	9,00	9,00	4,00



Folding shutters

The open shutters with upper folding, thanks to their modular design, can protect very large openings, even more than 50m of width.

Regardless to their final dimension, the shutters are mounted on-site assembling one or more standard modules of 6m width, in this way making the transport possible in the extreme cases and always less expensive.

The curtain is made of horizontal galvanized steel tubes of 18mm diameter, 1,0mm thickness, linked together with galvanized steel, moulded, vertical connecting rods, 120mm step.

The safe and smooth lift is guaranteed by special patented bilayer belts in high strength, coated, harmonic steel, which prove to be particularly resistant to vandalism.

The winding shaft is made of a robust galvanized tube, duly dimensioned to avoid flexing, and is equipped with special pulleys to hold the lifting belts.

The bottom slat is made of robust tubes which scroll in special side guides with the help of sliding carriages.

The stability of the curtain, when operated, is guaranteed by double U-shaped, gasketed, galvanized, moulded and bent, reinforced side scrolling rails, specially designed to allow the folding.

The shutters are motor-operated only: direct-drive or chain-drive are available. All shutters are equipped with a safety device to prevent accidental drops of the curtain. For the direct driven motor, the safety device is incorporated in the motor itself while for the chain driven motor the safety device is external.

A standard 24V low voltage control unit and a key unit accessible from outside are supplied.

The main structure of the shutter is made of HILTI profiles and is supplied by CONEGLIANO SERRAMENTI. The structure for anchoring the shutter to the building, when necessary or missing, is at customer's charge.



Detail of a chain-driven motor



Detail of the anti drop device and main structure with HILTI profiles

UPPER FOLDING SHUTTER P 120 - Patented -

Tube diameter/thickness (mm)	18,0 / 1,0
Material	Galvanized steel
Weight (kg/m ²)	8,00 + bottom slat
Max. opening width (m)	40,00





Special products Elite





Type S



Type E

ELITE-S

Material	Stainless steel
Wire diameter (mm)	3,0
Step between the wires (mm)	6,0
Braiding, nWires x diameter (mm)	4x2
Step between the braidings (mm)	50
Overall thick. of the curtain (mm)	7,0
Opened surface	40%
Weight (kg/m ²)	11,20
Max. opening width (m)	8,00

ELITE-E

Material	Stainless steel
Wire diameter (mm)	2,0
Step between the wires (mm)	15,8
Braiding, nWires x diameter (mm)	2,8x1
Coil step (mm)	8,7
Overall thick. of the curtain (mm)	7,0
Opened surface	30%
Weight (kg/m ²)	8,7
Max. opening width (m)	on request



Special products Polycarbonate



Detail

POLYCARBONATE SHUTTER P 83	
PC panel thickness (mm)	9,50
Overall thickness of the round part (mm)	23,00
Width of the slat (mm)	360,00
Material	Panel of transparent polycarbonate. Stainless steel tubes in AISI 316 or aluminium, diameter 16mm, thickness 2mm. Compatible with standard elements in galvanized steel and insulated elements in aluminium.
Transparency	87% Protection against UV rays
Weight (kg/m ²)	9,50 (35 panels/m ²)
Weight (kg/m)	0,815
Maximum opening width (m)	6,00
Wind pressure resistance	
Resistance to the fire	Class M2
Conformity to Directive EN 89/106/EEC	



Special products Windowed in aluminium



Vista interna

WINDOWED SHUTTER P 77

Overall thickness (mm)	19,00
Material	Extruded 2,0mm aluminium (polycarbonate on request).
Weight (kg/m ²)	8,45
Weight (kg/m)	0,65
Max. opening width (m)	6,00

Liberty



Special products - Liberty / Mix P 60

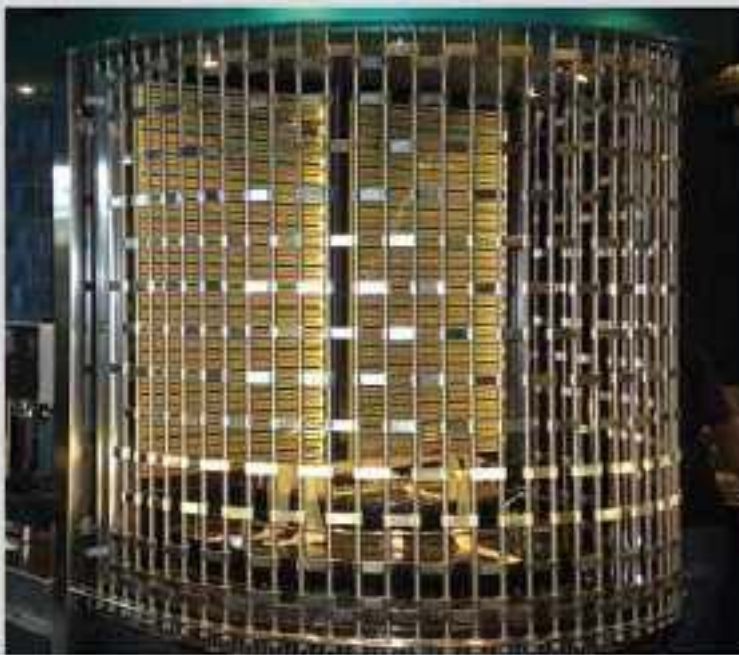

Closure of a bar counter



P 60 aluminium and stainless steel



Closure of a bar counter

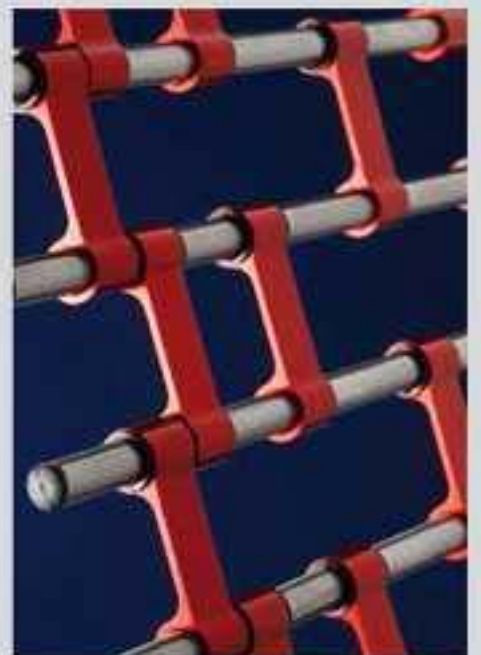

Various finishing and colours available



Motor



SI type, 380V side motor, torque from 750Nm to 1800Nm, TUV certified, IP54.



BOX type, 380V side motor, torque from 170Nm to 750Nm, TUV certified, IP54



220V or 24V axial motor, torque from 155Nm to 450Nm, IP20



220V or 24V tubular motor, torque from 30Nm to 100Nm, IP44

Control units



Control unit for shutters, operating voltage 400/230V 50/60Hz, 24V, IP66; all versions BoxControl are VDE and TUV certified according to norms EN12453, EN50178, EN60204.



Control unit for a motor having multiple operating logics, complete with integrated radio receiver 433,92 MHz, 64 codes. (programmable code/variable code)



Control unit for a motor having a basic operating mode and dead man's switch

Accessories



capacitive touch keypad



2 poles push button for indoor use



2 poles push button for outdoor use



emergency STOP push button



key switch with motor release for outdoor use



built-in key switch



key switch for outdoor use and reduced dimensions



key switch for outdoor use



built-in photocells



slim photocells of reduced dimensions



photocells for outdoor use



remote controls of reduced dimensions



2 and 4 channels remote controls



slim remote control



24v flashing light



PATENTED SYSTEM - HEAVY-DUTY USE
100.000 OPERATIONS *For type FORZA 3ESA



Kit FORZA:

- Motor with incorporated chain tensioner
- Torsion spring for octagonal tube of 70 mm
- Anti-drop system against spring breakage
- Support brackets for the shaft
- Adjustable cap on the motor side
- N°1 double channel remote control



“FORZA” is the first driving system for rolling shutters which need to be remotely controlled or subjected to a heavy-duty use. By using a 24V motor and an amperometric sensor for the obstacle detection, the system fulfils all the requirements of the norm UNI EN 13241-1 without any further need to install supplementary electrical sensing device in the bottom slat. Three kits are available, FORZA 1, FORZA 2ESA, FORZA 3ESA, according to the customer's needs or the dimensions of the shutter.

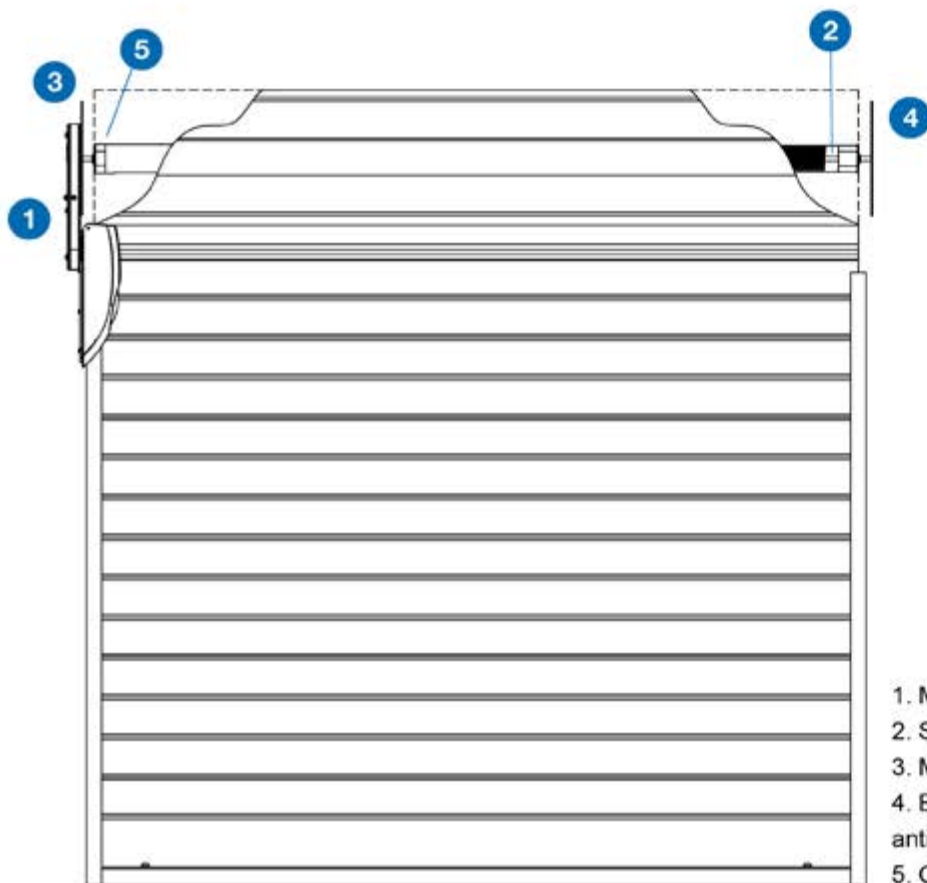

1. Moto
2. Spring
3. Motor bracket
4. Bracket and anti-drop system
5. Cap

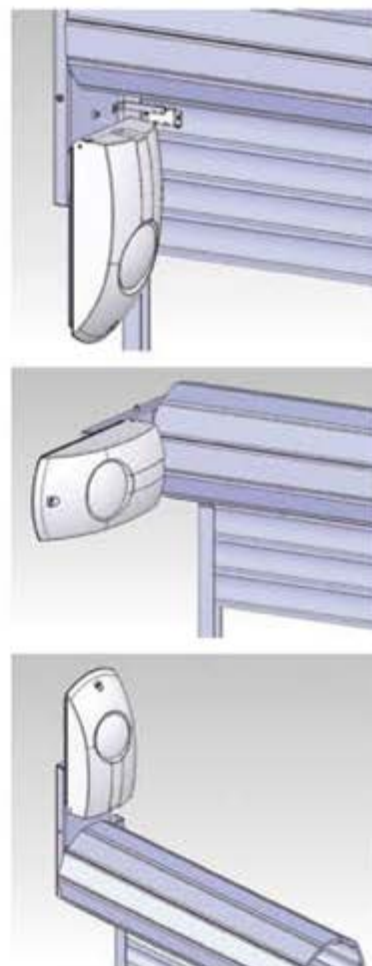

INNOVATIVE SYSTEM

Main characteristics:

- 24V motor drive, suitable for heavy-duty use
- Amperometric sensor for obstacle detection
- Anti-lift and anti-crush systems conform to the norm UNI EN 13241-1
- Manual release, from inside and outside
- Patented spring anti-break device
- 12V rechargeable buffer battery for emergency drive
- Incorporated radio-receiver
- Automatic closure
- Courtesy light
- Several positions available: indoor, outdoor, within the shutter frame, out of the shutter frame

For ESA systems only

- Energy saving
- Fault signal
- Access password
- Maintenance reporting
- Open/close meter
- Control unit with self-check function
- Slowdown in opening/closing

TECHNICAL DATA

	Forza 2ESA	Forza 3ESA
Voltage supply	230 Vac	230 Vac
Supply to motor	24 Vdc	24 Vdc
Maximum current load	0,7 A	1,5 A
Current in stand-by mode	8 mA	8 mA
Push/Pull force	600 N	1200 N
Max. weight to lift	80* Kg	120* Kg
Type of use	heavy-duty	heavy-duty
Degree of protection	IP 40	IP 40
Limit switch	electronic with encoder	electronic with encoder
Ambient temp. limits	-20°C +50°C	-20°C +50°C
Receiver unit	incorporated	incorporated

*with adapter gauge 101

www.forza-motion.com



CONEGLIANO SERRAMENTI s.r.l.

Via Campolongo, 1/D z. i. Ramera
31010 Mareno di Piave (TV) - Italy
Tel. +39 0438 4985
Fax +39 0438 492362

info@coneglianoserramenti.it
www.coneglianoserramenti.it

